

**PARTS CATALOGUE**  
**VER. 6**  
**JUNE 2019**

**[WWW.TOUGHDOG.COM.AU](http://WWW.TOUGHDOG.COM.AU)**

# TABLE OF CONTENTS

Version 6 - June 2019

*Unless specified otherwise, all listings in this catalogue are for 4WD (Four Wheel Drive) vehicles only.*

<b>WARRANTY</b>		
TERMS & CONDITIONS.....	5	
<b>PURCHASE ORDER FORM</b>		
<b>ROCK DOG</b>		
SLOW SPEED COMPETITION USE ONLY.....	7	
<b>RECOVERY GEAR</b>		
RECOVERY EQUIPMENT.....	8	
<b>ASIA MOTORS</b>		
ROCSTA		
JD, JS.....	10	
<b>DAEWOO</b>		
MUSSO		
INCLUDING UTE.....	11	
<b>DIAHATSU</b>		
F10 F20, F50, F60		
INCLUDING SCAT.....	12	
F25, F55, F65		
FEROZA		
CX12, F300.....	14	
FEROZA II		
F310.....	15	
ROCKY		
6/84-89 - F80, F85.....	16	
F77, F87 PICKUP & TRAYBACK.....	17	
F73, F78 (COIL SPRINGS).....	18	
<b>FORD</b>		
COURIER		
PC, PD, PE, PG, PH.....	19	
EVEREST		
UA1 Models.....	20	
EVEREST		
UA2 Models.....	22	
EXPLORER		
UN, UP, UQ.....	24	
F250		
Live Axle Front, Quad Rear Shocks.....	25	
BRONCO		
Third Generation.....	26	
RANGER		
PJ & PK, 2.5L & 3.0L.....	27	
PX & PX II- All Models.....	28	
PXIII All Models.....	30	
<b>GREAT WALL</b>		
UTE (WINGLE, SAILOR)		
V200, 240, 2.4L.....	32	
4 DOOR (HOVER, SAFE, HAVAL)		
X240.....	33	
<b>HOLDEN</b>		
FRONTERA LWB & SWB		
2 DOOR & 4 DOOR, 3.2L V6, 2.2L TDI.....	34	
JACKAROO, ISUZU TROOPER		
UBS13, 16, 52L.....	35	
UBS16, 17, 52, 55.....	36	
JACKAROO, MONTEREY		
UBS26, 69, 73 ( INC WIDE BODY).....	37	
RODEO		
KB4, KBD4.....	38	
TFS, G3, G6, R7, R9.....	40	
RODEO & COLORADO		
RA-RC.....	42	
COLORADO		
RG, MMU142, GM1700.....	44	
COLORADO 7/TRAILBLAZER		
ALL MODELS.....	46	
<b>HYUNDAI</b>		
TERRACAN		
HP.....	47	
<b>ISUZU</b>		
D-MAX		
MY09-MY11.....	48	
TFS85, V-CROSS, MY12.....	50	
MU-X		
MY13 On.....	52	
<b>JEEP</b>		
CHEROKEE		
XJ Limited, Sport.....	54	
WG, WJ - 6/99-05.....	55	
GRAND CHEROKEE		
WRANGLER		
TJ.....	56	

Vehicle fitment sheet must be completed when suspension fitted. Failure to do so may affect warranty.  
Fitment sheet can be found on page 200 of this catalogue

# TABLE OF CONTENTS

Version 6 - June 2019

*Unless specified otherwise, all listings in this catalogue are for 4WD (Four Wheel Drive) vehicles only.*

JK.....	57	MY16 on.....	86
<b>LAND ROVER</b>		<b>TRITON</b>	
80, 88 SWB, 109 LWB		ME, MF, MG, MH, MK.....	88
SERIES I, II, IIA & III.....	58	ML MN (To MY15).....	90
110 COUNTY ONLY.....	59	MQ (From MY16).....	92
<b>DEFENDER</b>		<b>NISSAN</b>	
90, 110, 130 Series.....	60	<b>NAVARA</b>	
<b>DISCOVERY</b>		D21, D22.....	94
SERIES I.....	62	D40 - 2.5L, 4.0L.....	96
SERIES III (4/05-2009).....	64	D40 - 3.0L STX-550 V6.....	98
<b>RANGE ROVER</b>		NP300 - Coil Rear Only.....	100
NON AIR SUSPENSION.....	65	NP300 - Leaf rear only.....	102
WITH AIR SUSPENSION.....	66	<b>PATHFINDER</b>	
<b>LADA</b>		WNYD21, WHYD21.....	104
<b>NIVA</b>		R50 (Series I, II, III).....	105
ALL.....	67	R51 - 2.5L, 4.0L.....	106
<b>MAZDA</b>		R51 - 3.0L V6.....	108
B2500, B2600		<b>PATROL</b>	
PC, PD, PE, PG, PH.....	68	9/80-85 MQ, MK.....	110
<b>BT-50</b>		GQ Patrol (Y60) - 2" Lift.....	112
B2500, B3000.....	69	GU Patrol (Y61) - 2" Lift.....	114
MY11 On.....	70	GQ, GU Patrol (Y60, Y61) - 3" Lift.....	116
<b>MERCEDES-BENZ</b>		GQ, GU Patrol (Y60, Y61) - 4" Lift.....	118
<b>X-CLASS UTE</b>		GQ, GU Patrol (Y60, Y61) - 5" Lift.....	120
X250D/X350D.....	72	GQ, GU Patrol (Y60, Y61) - 6" Lift.....	122
<b>MITSUBISHI</b>		GQ Cab Chassis (Leaf/Leaf).....	124
<b>CHALLENGER</b>		GQ, GU Cab Chassis (Coil/Leaf).....	126
PA - LEAF REAR.....	74	GQ, GU Cab Chassis (Coil/Coil).....	128
PA II - COIL REAR.....	75	Y62 (Non Hydraulic Suspension Only).....	130
MY10, 11LS & XLS.....	76	<b>TERRANO II</b>	
<b>L200 4WD</b>		R20.....	132
MA, MB, MC, MD.....	78	<b>SSANGYONG</b>	
<b>L300 4WD</b>		<b>MUSSO (INC SPORT UTE)</b>	
SC, SD, SE, SF, SG, SH.....	79	ALSO SEE DAEWOO.....	133
<b>PAJERO / MONTERO</b>		<b>SUZUKI</b>	
LEAF REAR.....	80	<b>JIMNY</b>	
COIL REAR.....	81	SN413 (JB33/43/48).....	134
NM onwards (LWB).....	82	JB74.....	136
NM onwards (SWB).....	84	<b>SIERRA</b>	
<b>PAJERO SPORT</b>		LEAF SPRING ONLY.....	138
		<b>VITARA</b>	

*Freight should be added where required. When determining spring choice, include only permanent accessories & weights. Towing requirements are not included in constant load determination*

# TABLE OF CONTENTS

Version 6 - June 2019

*Unless specified otherwise, all listings in this catalogue are for 4WD (Four Wheel Drive) vehicles only.*

INCLUDES GRAND VITARA & XL-7.....	139	All Models.....	198
<b>TOYOTA</b>		<b>RAV 4</b>	
<b>FORTUNER</b>		SAX 10, 11.....	200
04 - 12/15.....	140	<b>TUNDRA</b>	
15 On.....	142	UCK, UPK, USK 55, 56.....	201
<b>4RUNNER</b>		<b>UAZ</b>	
IFS WITH LEAF REAR.....	144	<b>ALL MODELS</b>	
IFS WITH COIL REAR.....	145	UAZ, HUNTER, PATRIOT.....	202
<b>HILUX</b>		<b>VOLKSWAGEN</b>	
LEAF/LEAF 4WD.....	146	<b>AMAROK</b>	
TORSION BAR FRONT.....	148	All Models.....	203
TORSION BAR FRONT.....	150	<b>FITTING SHEET</b>	
KUN26R (COIL/LEAF).....	152	PLEASE COMPLETE THIS FORM BEFORE ANY	
KUN26R - MINING APPLICATIONS.....	154	FITMENT.....	204
AN120/130 (COIL/LEAF).....	156	<b>CLAIMS FORM</b>	
<b>LANDCRUISER</b>		<b>WARRANTY &amp; RETURNS</b>	
40, 42 SERIES.....	158	<b>DISCLAIMER FORM</b>	
45, 47 SERIES.....	160	VEHICLES LIFTED MORE THAN 50MM.....	206
60, 61, 62 SERIES.....	162	<b>VEHICLE WEIGHT</b>	
70 SERIES BUNDERA.....	164	GVM & RELATED INFORMATION.....	207
71, 74 SERIES SWB & LWB.....	165		
70, 73, 74 SERIES.....	166		
75 SERIES.....	168		
76 SERIES WAGON.....	170		
77 SERIES FZJ77, HZJ77, PZJ77.....	172		
78 SERIES WITH COIL SPRINGS.....	173		
78, 79 SERIES INC V8 (EXCEPT DUAL CAB).....	174		
78, 79 SERIES INC V8 (EXCEPT DUAL CAB).....	175		
79 SERIES DUAL CAB.....	176		
80 & 105 SERIES.....	178		
80 & 105 SERIES 3" LIFT.....	180		
80 & 105 SERIES 4" LIFT.....	182		
80 & 105 SERIES 5" LIFT.....	184		
80 & 105 SERIES 6" LIFT.....	186		
100 SERIES (IFS).....	188		
200 Series.....	190		
<b>PRADO</b>			
95 SERIES.....	192		
120 SERIES LWB & SWB.....	194		
150 SERIES LWB & SWB.....	196		
<b>FJ CRUISER</b>			

Vehicle fitment sheet must be completed when suspension fitted. Failure to do so may affect warranty.  
Fitment sheet can be found on page 200 of this catalogue

# WARRANTY

## TERMS & CONDITIONS

**Please note: All Warranty Claims are to be made to the place of original purchase**

### **ACCOUNTS**

Account Applications that are approved must comply with the following Term & Conditions

1. All export orders must be prepaid before shipment
2. Credit terms are 30 days from the end of the trading month
3. Credit will be suspended if payment is not made within the trading terms.
4. Unpaid accounts at 30 days are on stop supply.
5. If no credit arrangement exists, all goods must be prepaid before leaving 4Way Suspension premises.
6. If Applicant is a company, the Directors Guarantee must be completed by all relevant parties.

### **FREIGHT & INSURANCE**

All Prices are quoted Ex-Warehouse and do not include freight. Goods pass to the buyer at the time they leave the 4Way Suspension Premises. Unless specified otherwise, freight will be added to the total cost of goods using the Supplier's preferred freight company.

### **CREDIT & WARRANTY RETURNS**

Goods for credit or exchange must be returned within fourteen (14) days of invoice date accompanied by a completed **Returns Form**. Goods returned for the purpose of warranty claim must also be accompanied by the returns form along with a copy of the customer invoice. Freight for returned goods can be arranged by the returned or by 4Way Suspension, but in both cases, the associated costs remain the responsibility of the returner.

**15% OF THE TOTAL VALUE OF THE RETURNED GOODS WILL BE CHARGED IN THE EVENT THAT REPACKAGING IS REQUIRED**

### **WARRANTY EXCLUSIONS**

1. Parts that have been incorrectly installed.
2. Struts that have been assembled with the use of any tool other than hand tools (no rattle guns etc)
3. Load bearing strut bushes that have been tightened while hanging. Strut bushes must be tightened while the vehicle is on the ground supporting its own load.
4. Interference between shock absorber and other suspension components.
5. Parts that have been involved in a motor vehicle accident or have been bent or have been physically damaged by impact of any kind.
6. Parts showing evidence of improper tightening of the mounting bolts causing parts to wear or bend.
7. Gripping tool marks (vice grips or multi grips) or any other tool made mark on the polished chrome section of the shock absorber shaft.
8. All parts subjected to abuse.
9. All parts used in Off-road or other racing events or activities.
10. Any special order parts
11. Parts fitted to vehicles weighing more than original GVM.

Please Note: Any components built to a special order or

specification outside the catalogue listings is not covered by warranty. The manufacturer is unable to design components to withstand stresses in applications that R&D has not approved.

### **PROOF OF PURCHASE**

A Copy of proof of purchase by the retail customer must be attached to the claim including the kilometre reading at the time of fitment (if applicable). Each 4WD Suspension fitted must have a fitting sheet completed and kept on file by either the vehicle owner or the fitment centre performing the work. Failure to produce the fitting sheet may affect the warranty of the product.

### **WARRANTY PERIODS**

<b>53mm Ralph (standard use)</b>	3 Year/unlimited km
<b>53mm Ralph (Commercial Use)</b>	2 Year/unlimited km
<b>45mm Adjustable</b>	3 Year/unlimited km
<b>45mm Adjustable (Comm. Use)</b>	2 Year/unlimited km
<b>35mm Nitro Gas Shocks</b>	2 Year/unlimited km
<b>Foam Cell &amp; 40mm Adjustable</b>	3 Year/unlimited km
<b>RTC/EXT/SV Dampers</b>	3 Year/unlimited km
<b>Leaf Springs</b>	3 Year/unlimited km
<b>Coil Springs (up to 2")</b>	3 year/unlimited km
<b>Coil Springs (above 2")</b>	2 year/unlimited km
<b>Recovery Equipment</b>	3 years (material & manufacture)

### **SELF FIT (DIY) SUSPENSIONS**

DIY suspension fitment does not affect the warranty application or term as long as the following conditions are adhered to:

1. A fitting sheet is completed prior to the suspension being fitted and filed for later reference.
2. The above fitment sheet accurately and clearly includes bottom of rim to wheel arch measurements for all four corners of the vehicle both before, after and at the 500km check service.
3. U-Bolts must be replaced at the time of fitment. U-Bolts are a 'stretch fit' item, and should not be torqued to tightness twice. Re-using U-Bolts puts the vehicle and occupants at risk.

### **WARRANTY LIMITS**

4way Suspension Products Pty Ltd's product warranty is limited to the repair or replacement of defective or faulty parts and does not include any costs incurred in labour for the removal or re-fitment of parts or damage incurred as a result of the product's fitment.

*Freight should be added where required. When determining spring choice, include only permanent accessories & weights. Towing requirements are not included in constant load determination*



# ROCK DOG

## ROCK CRAWLING COMPETITION COILOVERS

### SLOW SPEED COMPETITION USE ONLY

*Coilover setup can be complex - Please call (02) 9672 8899 to tailor a solution*

PART NO.	QTY	DESCRIPTION	RRP inc GST	NOTES
<b>SHOCK ABSORBERS</b>				
BMX45305	2	Shock - 12" Travel (505/810mm)		Includes Heim Joints
BMX45355	2	Shock - 14" Travel (565/910mm)		
BMX45406	2	Shock - 16" Travel (610/1015mm)		
<b>COIL SPRINGS</b>				
TDC-BMX160	2	160lbs Coil Spring		One Piece Design - Tender Built In
TDC-BMX180	2	180lbs Coil Spring		
TDC-BMX100	2	100lbs Tender Coil Spring		
TDC-BMX180T	2	180lbs Dual Rate (Tapered) Coil		
<b>Custom Coil Design Available - Contact us on (02) 9672 8899</b>				
<b>COMPONENTS</b>				
TDUK-2000	1	Urethane Spring Connector		Urethane seating Collar
TDUK-2001	1	Urethane Protector Sleeve		Protects shock body from spring
361321	1	QA1 Heim Joints		Replacement Unit



*Freight should be added where required. When determining spring choice, include only permanent accessories & weights. Towing requirements are not included in constant load determination*

**P: (02) 9672 8899 | F: (02) 9672 8099**



# RECOVERY GEAR

## RECOVERY EQUIPMENT

### RECOVERY KITS & COMPONENTS

PART NO.	QTY	DESCRIPTION	RRP inc GST	NOTES
<b>RECOVERY KITS</b>				
TDRK-08T	1	8T Complete Recovery Kit		Includes 8 Tonne Snatch Strap
TDRK-11T	1	11T Complete Recovery Kit		Includes 11 Tone Snatch Strap
<b>INDIVIDUAL RECOVERY COMPONENTS</b>				
TDRG-001	1	8 Tonne Snatch Strap		9 Metres 20% Stretch
TDRG-002	1	11T Snatch Strap		9 Metres 20% Stretch
TDRG-003	1	10T Tree Trunk Protector		3 Metres Double Stitched
TDRG-004	1	10T Winch Extension Strap		20 Metres
TDRG-005	1	10T Pulley Block		Greasable centre pin
TDRG-006	1	4.75T W.L.L Bow Shackle		Hot Dipped Galvanised Coating

### PRODUCT DETAILS

PART NO.	LENGTH	M.B.S	COLOUR	NOTES
<b>RECOVERY COMPONENTS</b>				
TDRG-001	9 M	8,000 kg	Yellow	100% Nylon, 20% Stretch
TDRG-002	9 M	11,000 kg	Orange	100% Nylon, 20% Stretch
TDRG-003	3 M	10,000 kg	Purple	
TDRG-004	20 M	10,000 kg	Green	
TDRG-005		10,000 kg	Yellow	Greasable centre pin
TDRG-006		4.75T W.L.L	Yellow	Hot Dipped Galvanised Coating
Damper Blanket			Black	PVC Blanket with weight pockets
Gloves			Black	Synthetic outer leather palm with grip palm & finger pads
Storage Bag			Red/Black	1200 Denier Material, Self supporting main opening.

Vehicle fitment sheet must be completed when suspension fitted. Failure to do so may affect warranty.  
Fitment sheet can be found on page 200 of this catalogue



# RECOVERY GEAR

## COMPLETE KIT INCLUDES



1	9T Snatch Strap
	OR
1	11T Snatch Strap
1	10T Winch Extension Strap
1	10T Tree Trunk Protector
1	10T Pulley Block
2	4.75T W.L.L Bow Shackles
1	Pair Gloves
1	Recovery Damper Blanket
1	Heavy Duty Recovery Bag



8T & 11T Snatch Strap



10T Winch Extension Strap



10T Tree Trunk Protector



Heavy Duty 1200 Denier Recovery Bag



4.75T Bow Shackles



10T Pulley Block



Heavy Duty Gloves

Freight should be added where required. When determining spring choice, include only permanent accessories & weights. Towing requirements are not included in constant load determination

# ASIA MOTORS

**ROCSTA**  
7/93-00  
JD, JS



## FRONT SUSPENSION

**ESTIMATED LIFT: 50mm**

PART NO.	QTY	DESCRIPTION	RRP inc GST	NOTES
<b>SHOCK ABSORBERS</b>				
BD1102T	2	35mm Nitrogen Gas Shock		Suits OE Height Only
BM401102	2	40mm 9 Stage Adjustable Shock		
BD1104T	2	35mm Nitrogen Gas		Suits 50mm Lift
BM401104	2	40mm 9 Stage Adjustable		
<b>COMPONENTS</b>				
SD5700	1	Steering Damper		
<b>COMPONENTS</b>				
TDUK-001	1	Urethane Shackle Bushing Kit		
TDUB-001	2	U-Bolt Kit		

## REAR SUSPENSION

<b>SHOCK ABSORBERS</b>				
BD1364T	2	35mm Nitrogen Gas Shock		Suit OE Height
BM401364	2	40mm 9 Stage Adjustable Shock		
BD1366T	2	35mm Nitrogen Gas		Suit 50mm Lift
BM401366	2	40mm 9 Stage Adjustable		
<b>COMPONENTS</b>				
TDUK-001	1	Urethane Shackle Bushing Kit		
TDUB-001	2	U-Bolt Kit		

## REPLACEMENT BUSHINGS

QUANTITY PER SHOCK				
TW959	2	Front Top Pin Mount		Pin Style Bushing
404702	1	Bottom Front Eying		Eying Bushing
404702	2	Top & Bottom Rear Eying		Eying Bushing

Vehicle fitment sheet must be completed when suspension fitted. Failure to do so may affect warranty.  
Fitment sheet can be found on page 200 of this catalogue



# DAEWOO

## MUSSO

7/98-02

**INCLUDING UTE**

### FRONT SUSPENSION

**ESTIMATED LIFT: 35mm**

PART NO.	QTY	DESCRIPTION	RRP inc GST	NOTES
<b>SHOCK ABSORBERS</b>				
BD2057T	2	35mm Nitrogen Gas Shock		Suits up to 35mm Lift
<b>TORSION BARS</b>				
4WTB-1800	1	Replacement Torsion Bars (Pair)		26mm/1040mm
<b>Adjust Torsion bars after fitting shocks - Ensure a minimum of 60mm Droop is Maintained</b>				

### REAR SUSPENSION

<b>SHOCK ABSORBERS</b>				
BD1104T	2	35mm Nitrogen Gas Shock		Suit OE Height
BM401104	2	40mm 9 Stage Adjustable Shock		
BD1105T	2	35mm Nitrogen Gas		Suit 35mm Lift
BM401105	2	40mm 9 Stage Adjustable		
<b>COIL SPRINGS</b>				
TDC100	2	0-300KG Load		35mm Lift
TDC100H	2	<b>CONSTANT</b> 300Kg Load		35mm Lift

### REPLACEMENT BUSHINGS

QUANTITY PER SHOCK				
TW959	2	Front Top Pin Mount		Pin Style Bushing
412772	1	Bottom Front Eying		Eying Bushing
TW959	2	Rear Top Pin Mount		Pin Style Bushing
404702	1	Bottom Rear Eying		Eying Bushing

### COMPLETE KIT PRICE REFERENCE

SHOCK CHOICE	SPRING CHOICE	RRP inc GST	CONTENTS
35mm Nitrogen Gas	ANY		
40mm 9 Stage Adjustable	ANY		
<b>Includes</b>			
4 x Shocks    2 x Coil Springs			

Freight should be added where required. When determining spring choice, include only permanent accessories & weights. Towing requirements are not included in constant load determination

**P: (02) 9672 8899 | F: (02) 9672 8099**



# DIAHATSU

F10 F20, F50, F60

8/75-84

INCLUDING SCAT



## FRONT SUSPENSION

**ESTIMATED LIFT: No Springs Avail.**

PART NO.	QTY	DESCRIPTION	RRP inc GST	NOTES
<b>SHOCK ABSORBERS</b>				
BD1364T	2	35mm Nitrogen Gas Shock		Suits OE Height Only
BM401364	2	40mm 9 Stage Adjustable Shock		
BD1366T	2	35mm Nitrogen Gas		Suits 50mm Lift
BM401366	2	40mm 9 Stage Adjustable		
<b>COMPONENTS</b>				
TDUK-019	1	Urethane Shackle Bushing Kit		All Excluding F50
TDUK-020	1	Urethane Shackle Bushing Kit		Suits F50 Only
TDUB-027	2	U-Bolt Kit		

## REAR SUSPENSION

<b>SHOCK ABSORBERS</b>				
BD1366T	2	35mm Nitrogen Gas Shock		Suit OE Height
BM401366	2	40mm 9 Stage Adjustable Shock		
BD1382T	2	35mm Nitrogen Gas		Suit 50mm Lift
BM401382	2	40mm 9 Stage Adjustable		
<b>COMPONENTS</b>				
TDUK-019	1	Urethane Shackle Bushing Kit		All Excluding F50
TDUK-020	1	Urethane Shackle Bushing Kit		Suits F50 Only
TDUB-027	2	U-Bolt Kit		

## REPLACEMENT BUSHINGS

QUANTITY PER SHOCK				
404702	2	Suits Top & Bottom Front & Rear		Eyering Bushing

Vehicle fitment sheet must be completed when suspension fitted. Failure to do so may affect warranty.  
Fitment sheet can be found on page 200 of this catalogue



# DIAHATSU

**F25, F55, F65**  
2/80-84

## FRONT SUSPENSION

**ESTIMATED LIFT: No Springs Avail.**

PART NO.	QTY	DESCRIPTION	RRP inc GST	NOTES
<b>SHOCK ABSORBERS</b>				
BD1366T	2	35mm Nitrogen Gas Shock		Suits OE Height Only
BM401366	2	40mm 9 Stage Adjustable Shock		
BD1382T	2	35mm Nitrogen Gas		Suits 50mm Lift
BM401382	2	40mm 9 Stage Adjustable		
<b>COMPONENTS</b>				
TDUK-002	1	Urethane Shackle Bushing Kit		
TDUB-027	2	U-Bolt Kit		

## REAR SUSPENSION

<b>SHOCK ABSORBERS</b>				
BD1400T	2	35mm Nitrogen Gas Shock		Suit OE Height
BM401400	2	40mm 9 Stage Adjustable Shock		
BD1441T	2	35mm Nitrogen Gas		Suit 50mm Lift
BM401441	2	40mm 9 Stage Adjustable		
<b>COMPONENTS</b>				
TDUK-023	1	Urethane Shackle Bushing Kit		
TDUB-027	2	U-Bolt Kit		

## REPLACEMENT BUSHINGS

QUANTITY PER SHOCK				
404702	2	Suits Top & Bottom Front Shock		Eyering Bushing
404702	1	Suits Top Eyering Mount Rear		Eyering Bushing
TW959	2	Suits Bottom Pin Mount Rear		Pin Style Bushing

*Freight should be added where required. When determining spring choice, include only permanent accessories & weights. Towing requirements are not included in constant load determination*

# DIAHATSU

## FEROZA

10/88-98

CX12, F300



### FRONT SUSPENSION

**ESTIMATED LIFT: 40mm**

PART NO.	QTY	DESCRIPTION	RRP inc GST	NOTES
<b>SHOCK ABSORBERS</b>				
BD2057T	2	35mm Nitrogen Gas Shock		All Applications
<b>TORSION BARS</b>				
4WTB-0197	1	Replacement Torsion Bars (Pair)		26mm/1093mm
<b>Adjust Torsion bars after fitting shocks - Ensure a minimum of 60mm Droop is Maintained</b>				

### REAR SUSPENSION

<b>SHOCK ABSORBERS</b>				
BD1102T	2	35mm Nitrogen Gas Shock		Suit OE Height
BM401102	2	40mm 9 Stage Adjustable Shock		
BD1104T	2	35mm Nitrogen Gas		Suit 40mm Lift
BM401104	2	40mm 9 Stage Adjustable		
<b>LEAF SPRINGS</b>				
T67	2	0-300Kg Load		40mm Lift
<b>COMPONENTS</b>				
TDUK-003	1	Urethane Shackle Bushing Kit		
TDUB-027	2	U-Bolt Kit		

### REPLACEMENT BUSHINGS

QUANTITY PER SHOCK				
TW959	2	Suits Top Front Pin Bushing		Pin Style Bushing
412772	1	Suits Bottom Front Eye Bushing		Eyering Bushing
TW959	2	Suits Top Rear Pin Bushing		Pin Style Bushing
404702	1	Suits Bottom Rear Eye Bushing		Eyering Bushing

### COMPLETE KIT PRICE REFERENCE

SHOCK CHOICE	SPRING CHOICE	RRP inc GST	CONTENTS
35mm Nitrogen Gas	0-300KG		
40mm 9 Stage Adjustable	0-300KG		
<b>Includes</b> 2 x Leaf Springs      4 x Shocks 1x Urethane Kits      2x U-Bolt Kits			

Vehicle fitment sheet must be completed when suspension fitted. Failure to do so may affect warranty.  
Fitment sheet can be found on page 200 of this catalogue



# DIAHATSU

## FEROZA II

4/93-99  
F310

### FRONT SUSPENSION

**ESTIMATED LIFT: 40mm**

PART NO.	QTY	DESCRIPTION	RRP inc GST	NOTES
<b>SHOCK ABSORBERS</b>				
BD2057T	2	35mm Nitrogen Gas Shock		All Applications
<b>TORSION BARS</b>				
4WTB-0197	1	Replacement Torsion Bars (Pair)		26mm/1093mm
<b>Adjust Torsion bars after fitting shocks - Ensure a minimum of 60mm Droop is Maintained</b>				

### REAR SUSPENSION

<b>SHOCK ABSORBERS</b>				
BD1005T	2	35mm Nitrogen Gas Shock		Suit OE Height
BM401005	2	40mm 9 Stage Adjustable Shock		
BD1007T	2	35mm Nitrogen Gas		Suit 40mm Lift
BM401007	2	40mm 9 Stage Adjustable		
<b>LEAF SPRINGS</b>				
T76	2	0-300Kg Load		40mm Lift
<b>COMPONENTS</b>				
TDUK-022	1	Urethane Shackle Bushing Kit		
TDUB-027	2	U-Bolt Kit		

### REPLACEMENT BUSHINGS

QUANTITY PER SHOCK				
TW959	2	Suits Top Front Pin Bushing		Pin Style Bushing
412772	1	Suits Bottom Front Eye Bushing		Eyering Bushing
TW959	2	Suits Top Rear Pin		Pin Style Bushing
404702	2	Suits Bottom Rear Eyering		Eyering Bushing

### COMPLETE KIT PRICE REFERENCE

SHOCK CHOICE	SPRING CHOICE	RRP inc GST	CONTENTS
35mm Nitrogen Gas	0-300KG		
40mm 9 Stage Adjustable	0-300KG		
<b>Includes</b> 4 x Leaf Springs      4 x Shocks 2x Urethane Kits    4x U-Bolt Kits			

Freight should be added where required. When determining spring choice, include only permanent accessories & weights. Towing requirements are not included in constant load determination

# DIAHATSU

## ROCKY

6/84-93 - F70, F75

6/84-89 - F80, F85



### FRONT SUSPENSION

**ESTIMATED LIFT: 40mm**

PART NO.	QTY	DESCRIPTION	RRP inc GST	NOTES
<b>SHOCK ABSORBERS</b>				
BD1102TB	2	35mm Nitrogen Gas Shock		Suit OE Height
BM401102	2	40mm 9 Stage Adjustable Shock		
BD1104TB	2	35mm Nitrogen Gas		Suit 40mm Lift
BM401104	2	40mm 9 Stage Adjustable		
<b>LEAF SPRINGS</b>				
T65	2	Petrol/Diesel/Bar		Suits LWB Only
T65C	2	Petrol/Diesel/Bar		Suits SWB Only
<b>COMPONENTS</b>				
TDUK-002	1	Urethane Shackle Bushing Kit		
TDUB-002	1	U-Bolt Kit		Suits D/S (1 Kit Req'd)
TDUB-027	1	U-Bolt Kit		Suits P/S (1 Kit Req'd)

### REAR SUSPENSION

<b>SHOCK ABSORBERS</b>				
BD1400T	2	35mm Nitrogen Gas Shock		Suit OE Height
BM401400	2	40mm 9 Stage Adjustable Shock		
BD1104T	2	35mm Nitrogen Gas		Suit 40mm Lift
BM401104	2	40mm 9 Stage Adjustable		
<b>LEAF SPRINGS</b>				
T64	2	0-300Kg Load		Suits LWB Only
T64M	2	0-300Kg Load		Suits SWB Only
<b>COMPONENTS</b>				
TDUK-003	1	Urethane Shackle Bushing Kit		
TDUB-027	2	U-Bolt Kit		

### REPLACEMENT BUSHINGS

QUANTITY PER SHOCK				
TW959	2	Suits Top Pin - Front & Rear		Pin Style Bushing
404702	2	Suits Bottom Eye - Front & Rear		Eyering Bushing

### COMPLETE KIT PRICE REFERENCE

SHOCK CHOICE	SPRING CHOICE	RRP inc GST	CONTENTS
35mm Nitrogen Gas	0-300KG SWB		
	0-300KG LWB		
40mm 9 Stage Adjustable	0-300KG SWB		
	0-300KG LWB		
<b>Includes</b> 4 x Leaf Springs      4 x Shocks 2x Urethane Kits      4x U-Bolt Kits			

Vehicle fitment sheet must be completed when suspension fitted. Failure to do so may affect warranty.  
Fitment sheet can be found on page 200 of this catalogue





# DIAHATSU

## ROCKY

11/86-93

### F77, F87 PICKUP & TRAYBACK

## FRONT SUSPENSION

**ESTIMATED LIFT: No Springs Avail.**

PART NO.	QTY	DESCRIPTION	RRP inc GST	NOTES
<b>SHOCK ABSORBERS</b>				
BD1102TB	2	35mm Nitrogen Gas Shock		Suit OE Height
BM401102	2	40mm 9 Stage Adjustable Shock		
BD1104TB	2	35mm Nitrogen Gas		Suit 40mm Lift
BM401104	2	40mm 9 Stage Adjustable		
<b>COMPONENTS</b>				
TDUK-002	1	Urethane Shackle Bushing Kit		
TDUB-002	2	U-Bolt Kit		

## REAR SUSPENSION

<b>SHOCK ABSORBERS</b>				
BD1400T	2	35mm Nitrogen Gas Shock		Suit OE Height
BM401400	2	40mm 9 Stage Adjustable Shock		
BD1441T	2	35mm Nitrogen Gas		Suit 40mm Lift
BM401441	2	40mm 9 Stage Adjustable		
<b>COMPONENTS</b>				
TDUB-027	2	U-Bolt Kit		

## REPLACEMENT BUSHINGS

<b>QUANTITY PER SHOCK</b>				
TW959	2	Suits Pin - Front & Rear		Pin Style Bushing
404702	1	Suits Eye - Front & Rear		Eyering Bushing

*Freight should be added where required. When determining spring choice, include only permanent accessories & weights. Towing requirements are not included in constant load determination*

# DIAHATSU

## ROCKY

8/93-99

F73, F78 (COIL SPRINGS)



### FRONT SUSPENSION

**ESTIMATED LIFT: 40mm**

PART NO.	QTY	DESCRIPTION	RRP inc GST	NOTES
<b>SHOCK ABSORBERS</b>				
FC42019B	2	41mm Foam Cell Shock		
<b>TORSION BARS</b>				
4WTB-0198	1	Replacement Torsion Bars		26mm/1093mm
<b>Adjust Torsion bars after fitting shocks - Ensure a minimum of 60mm Droop is Maintained</b>				

### REAR SUSPENSION

<b>SHOCK ABSORBERS</b>				
FC41184	2	41mm Foam Cell Shock		
BM401184	2	40mm 9 Stage Adjustable		
<b>COIL SPRINGS</b>				
TDC066	2	0-300Kg Load		40mm Lift

### REPLACEMENT BUSHINGS

QUANTITY PER SHOCK				
TW959	2	Suits Top Front Pin		Pin Style Bushing
412772	1	Suits Bottom Front Eye		Eyering Bushing
TW959	2	Suits Top Rear Pin		Pin Style Bushing

### COMPLETE KIT PRICE REFERENCE

SHOCK CHOICE	SPRING CHOICE	RRP inc GST	CONTENTS
41mm Foam Cell	0-300KG		
Foam Cell Front	0-300KG		
Adjustable Rear			
<b>Includes</b> 4 x Shock Absorbers      2 x Coil Springs			

Vehicle fitment sheet must be completed when suspension fitted. Failure to do so may affect warranty.  
Fitment sheet can be found on page 200 of this catalogue



# FORD COURIER 5/87-10/06 PC, PD, PE, PG, PH

## FRONT SUSPENSION

**ESTIMATED LIFT: 40mm**

PART NO.	QTY	DESCRIPTION	RRP inc GST	NOTES
<b>SHOCK ABSORBERS</b>				
FC42051B	2	41mm Foam Cell Shock		Suits up to 40mm Lift
TDSK-020	1	Shock Mount Strengthening Kit		Top Pin Mount Bracket
<b>Please Note: - Failure to fit TDSK-020 will cause top mount failure. Fitting instructions at <a href="http://toughdog.com.au">toughdog.com.au</a></b>				
<b>TORSION BARS</b>				
4WTB-1546	1	Replacement Torsion Bars		26mm/926mm
<b>Adjust Torsion bars after fitting shocks - Ensure a minimum of 60mm Droop is Maintained</b>				

## REAR SUSPENSION

<b>SHOCK ABSORBERS</b>				
BD1232T	2	35mm Nitrogen Gas Shock		Suits Up to 40mm Lift
FC41232	2	41mm Foam Cell Shock		Suits Up to 40mm Lift
BM401232	2	40mm 9 Stage Adjustable		Suits Up to 40mm Lift
<b>LEAF SPRINGS</b>				
FS365	2	0-300kg Load		40mm Lift
FS367	2	<b>CONSTANT</b> 300Kg Load		40mm Lift
<b>COMPONENTS</b>				
TDUK-034	1	Urethane Shackle Bushing Kit		
TDUB-005	2	U-Bolt Kit		

## REPLACEMENT BUSHINGS

QUANTITY PER SHOCK				
TW959 + TW961	2	Suits Top Front & Rear Pin		Pin Style Bushing
412772	1	Suits Bottom Front & Rear Eye		Eyering Bushing
ADJ00191	1	Suits Top Rear Eyering		Suit Foam Cell Shocks
SPF420-02	1	Suits Bottom Rear Eyering		
230100	1	Suits Top Rear Eyering		Suit 40mm Adjustable Shocks
230002	1	Suits Bottom Rear Eyering		

## COMPLETE KIT PRICE REFERENCE

SHOCK CHOICE	SPRING CHOICE	RRP inc GST	CONTENTS
Foam Cell Front Nitro gas Rear	0-300KG Constant 300kg		
41mm Foam Cell	0-300KG Constant 300kg		
Foam Cell Front Adjustable Rear	0-300KG Constant 300kg		
2 x Leaf Springs 2 x U-Bolt Kits	Includes 4 x Shocks 1 x Urethane Kits 1 x Shock Strengthening Kit		

Freight should be added where required. When determining spring choice, include only permanent accessories & weights. Towing requirements are not included in constant load determination

# FORD

## EVEREST

2015 - 08/2018  
UA1 Models



### FRONT SUSPENSION

**ESTIMATED LIFT: 40mm**

PART NO.	QTY	DESCRIPTION	RRP inc GST	NOTES
<b>SHOCK ABSORBERS</b>				
FC404500	2	40mm Foam Cell Strut		
BM404500	2	40mm Adjustable Strut		9 Stage Adjustable
<b>COIL SPRINGS</b>				
TDC452	2	40mm Lift Spring		Petrol/Diesel/Bar
TDC452HL	2	40mm Lift Spring		Petrol/Diesel/Bar/Winch
<b>COMPLETE STRUT ASSEMBLY</b>				
MAZ-005	2	BM404500/TDC452		Petrol/Diesel/Bar
MAZ-006	2	BM404500/TDC452HL		Petrol/Diesel/Bar/Winch
MAZ-007	2	FC404500/TDC452		Petrol/Diesel/Bar
MAZ-008	2	FC404500/TDC452HL		Petrol/Diesel/Bar/Winch
<b>REPLACEMENT STRUT TOP</b>				
MAZ-4051	2	Strut Top		Replacement Strut Top

### REAR SUSPENSION

<b>SHOCK ABSORBERS</b>				
FC43013	2	41mm Foam Cell Shock		Suits Up to 40mm Lift
BM403013	2	40mm 9 Stage Adjustable		Suits Up to 40mm Lift
<b>COIL SPRINGS</b>				
TDC453	2	0-300kg Load		40mm Lift
TDC453L	2	<b>CONSTANT</b> 300Kg Load		40mm Lift
<b>AIR ASSIST BAGS</b>				
TDAA-004	1	Coil insert bag kit		Suits 40mm Lift

### REPLACEMENT BUSHINGS

QUANTITY PER SHOCK				
MAZ-4051	1	Replacement Strut Top		Available As Complete Unit Only
ADJ00305	1	Suits Bottom Front Eye		Eyering Bonded Bushing





Vehicle fitment sheet must be completed when suspension fitted. Failure to do so may affect warranty.  
Fitment sheet can be found on page 200 of this catalogue

# FORD

## EVEREST

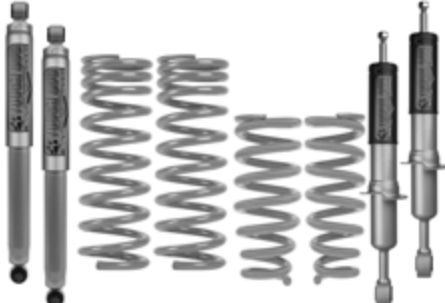
2015 - 08/2018  
UA1 Models

### COMPLETE KIT PRICE REFERENCE

SHOCK CHOICE	SPRING CHOICE	RRP inc GST	CONTENTS
<p><b>Foam Cell Struts Require Assembly</b> Includes 4 x Coil Springs 4 x Shocks</p>	ANY		
<p><b>Foam Cell Complete Assembly Struts</b> Includes 2 x Front Strut Assy 2 x Coil Springs 2 x Rear Shocks</p>	ANY		
<p><b>40mm Adjustable Struts Require Assembly</b> Includes 4 x Coil Springs 4 x Shocks</p>	ANY		
<p><b>40mm Adjustable Complete Assembly Struts</b> Includes 2 x Front Strut Assy 2 x Coil Springs 2 x Rear Shocks</p>	ANY		

Freight should be added where required. When determining spring choice, include only permanent accessories & weights. Towing requirements are not included in constant load determination

# FORD

## EVEREST

08/2018 on  
UA2 Models



### FRONT SUSPENSION

**ESTIMATED LIFT: 40mm**

PART NO.	QTY	DESCRIPTION	RRP inc GST	NOTES
<b>SHOCK ABSORBERS</b>				
FC404520	2	40mm Foam Cell Strut		
BM404520	2	40mm Adjustable Strut		9 Stage Adjustable
<b>COIL SPRINGS</b>				
TDC1006	2	40mm Lift Spring		Diesel no accessories
TDC1007	2	40mm Lift Spring		Diesel with Bar or Bar+Winch
<b>COMPLETE STRUT ASSEMBLY</b>				
FOR-005	2	BM404520/TDC1006		Diesel no accessories
FOR-006	2	BM404520/TDC1007		Diesel with Bar or Bar+Winch
FOR-007	2	FC404520/TDC1006		Diesel no accessories
FOR-008	2	FC404520/TDC1007		Diesel with Bar or Bar+Winch
<b>REPLACEMENT STRUT TOP</b>				
FOR-4520	2	Strut Top		Replacement Strut Top

### REAR SUSPENSION





<b>SHOCK ABSORBERS</b>				
FC43013	2	41mm Foam Cell Shock		Suits Up to 40mm Lift
BM403013	2	40mm 9 Stage Adjustable		Suits Up to 40mm Lift
<b>COIL SPRINGS</b>				
TDC453	2	0-300kg Load		40mm Lift
TDC453L	2	<b>CONSTANT</b> 300Kg Load		40mm Lift
<b>AIR ASSIST BAGS</b>				
TDAA-004	1	Coil insert bag kit		Suits 40mm Lift

### REPLACEMENT BUSHINGS

QUANTITY PER SHOCK				
MAZ-4520	1	Replacement Strut Top		Available As Complete Unit Only
ADJ00306	1	Suits Bottom Front Eye		Eyering Bonded Bushing

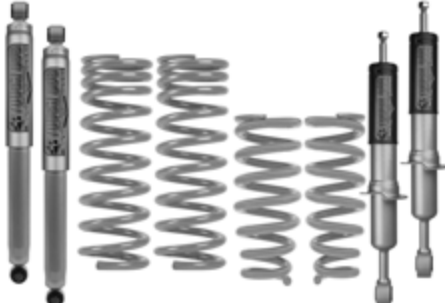
Vehicle fitment sheet must be completed when suspension fitted. Failure to do so may affect warranty.  
Fitment sheet can be found on page 200 of this catalogue

### COMPLETE KIT PRICE REFERENCE

SHOCK CHOICE	SPRING CHOICE	RRP inc GST	CONTENTS
<p><b>Foam Cell Struts Require Assembly</b> Includes 4 x Coil Springs 4 x Shocks</p>	ANY		
<p><b>Foam Cell Complete Assembly Struts</b> Includes 2 x Front Strut Assy 2 x Coil Springs 2 x Rear Shocks</p>	ANY		
<p><b>40mm Adjustable Struts Require Assembly</b> Includes 4 x Coil Springs 4 x Shocks</p>	ANY		
<p><b>40mm Adjustable Complete Assembly Struts</b> Includes 2 x Front Strut Assy 2 x Coil Springs 2 x Rear Shocks</p>	ANY		

Freight should be added where required. When determining spring choice, include only permanent accessories & weights. Towing requirements are not included in constant load determination

# FORD

## EXPLORER

10/96-05  
UN, UP, UQ



### FRONT SUSPENSION

**ESTIMATED LIFT: 40mm**

PART NO.	QTY	DESCRIPTION	RRP inc GST	NOTES
<b>SHOCK ABSORBERS</b>				
FC41450B	2	41mm Foam Cell Shock		Suits up to 40mm Lift

### REAR SUSPENSION

<b>SHOCK ABSORBERS</b>				
FC41446	2	41mm Foam Cell Shock		Suits Up to 40mm Lift

### COMPLETE KIT PRICE REFERENCE

SHOCK CHOICE	SPRING CHOICE	RRP inc GST	CONTENTS
41mm Foam Cell	0-300KG		
<p><b>Includes</b> 4 x Shocks</p>			

**Please Note:**

1) The "Limited" comes standard with (Self Levelling) air shocks. These can be retained or removed as desired. If the (Self Levelling) air shocks are removed, the self levelling indicator light in the dash will turn on and off intermittently.

The air hoses should be sealed off and fastened to the chassis for later use if needed.

2) The air compressor must be turned off. The switch is located in the left hand rear inspection console. If further electrical work is required, please consult an Automotive Electrician.

*Vehicle fitment sheet must be completed when suspension fitted. Failure to do so may affect warranty.  
Fitment sheet can be found on page 200 of this catalogue*





# FORD

**F250**  
**03-06**

**Live Axle Front, Quad Rear Shocks**

## FRONT SUSPENSION

**ESTIMATED LIFT: 100 mm**

PART NO.	QTY	DESCRIPTION	RRP inc GST	NOTES
<b>SHOCK ABSORBERS</b>				
TDR3500	2	53mm 'Ralph' Big Bore		Suits OE Height Only
BMX3500/4	2	45mm 9 Stage Adjustable		Suits 100mm Lift
<b>LEAF SPRINGS</b>				
FS026	2	Petrol/Diesel/Alloy Bar		100mm Lift
FS026H	2	Petrol/Diesel/Bar/Winch		100mm Lift
<b>STEERING DAMPER</b>				
SS5250-XHD	1	XHD Return To Centre Damper		When fitted to OE height vehicle, Low ground clearance occurs
SV5250	1	'SV' 9 Stage Adjustable Damper		
<b>COMPONENTS</b>				
TDUK-064	1	Shackle Bushing Kit		Kit fitted to springs when ordered
TDUB-033	2	U-Bolt Kit		
TDPR-250	1	Adjustable Panhard Rod		

## REAR SUSPENSION

<b>SHOCK ABSORBERS</b>				
BMX3501	2	45mm 9 Stage Adjustable		Forward of Rear Axle - OE Height
BMX3502	2	45mm 9 Stage Adjustable		Rear of Rear Axle - OE Height
BMX3501/4	2	45mm 9 Stage Adjustable		Forward of Rear Axle - 100mm lift
BMX3502/4	2	45mm 9 Stage Adjustable		Rear of Rear Axle - 100mm lift
<b>LEAF SPRINGS</b>				
FS027	2	0-500kg Load		100mm Lift
FS027H	2	<b>CONSTANT</b> 500Kg Load		100mm Lift
<b>COMPONENTS</b>				
TDUK-064	1	Shackle Bushing Kit		Kit fitted to springs when ordered
TDUB-034	2	U-Bolt Kit		

## REPLACEMENT BUSHINGS

QUANTITY PER SHOCK				
TW038-16	1	Suits top mount all shocks		Eyering Bonded Bushing
TW038-12	1	Suits bottom mount all shocks		Eyering Bonded Bushing

## COMPLETE KIT PRICE REFERENCE

SHOCK CHOICE	SPRING CHOICE	RRP inc GST	CONTENTS
<b>45mm 9 Stage Adjustable</b>	<b>0-500KG</b> <b>Constant 500kg</b>		
<b>Includes</b> <b>4 x Leaf Springs    6 x Shocks    2 x Bushing Kits</b> <b>4 x U-Bolt Kits    1 x Panhard Rod</b>			

Freight should be added where required. When determining spring choice, include only permanent accessories & weights. Towing requirements are not included in constant load determination

**P: (02) 9672 8899 | F: (02) 9672 8099**



# FORD

## BRONCO

3/81-89

Third Generation



### FRONT SUSPENSION

**ESTIMATED LIFT: No Springs Avail.**

PART NO.	QTY	DESCRIPTION	RRP inc GST	NOTES
<b>SHOCK ABSORBERS (ALL EXCL. QUAD SHOCK)</b>				
FC41130B	2	41mm Foam Cell Shock		Suits up to 30mm Lift
<b>SHOCK ABSORBERS (QUAD SHOCK)</b>				
FC41102B	2	41mm Foam Cell Shock		OE Height - Front of Axle
FC41130B	2	41mm Foam Cell Shock		OE Height - Rear of Axle

### REAR SUSPENSION

<b>SHOCK ABSORBERS (ALL MODELS)</b>				
FC41379	2	41mm Foam Cell Shock		Suits Up to 30mm Lift

### REPLACEMENT BUSHINGS

<b>QUANTITY PER SHOCK</b>				
TW959	2	Suits Top Front Pin		Pin Style Bushing (#1102B ONLY)
404702	1	Suits Bottom Front Eye		Eyering Bushing (#1102B ONLY)
404702	1	Suits Top Rear		Eyering Bushing
SPF420	1	Suits Bottom Rear		Eyering Bushing

### REPLACEMENT BUSHINGS SUIT 06-2011 Ranger (not Bronco)

<b>QUANTITY PER SHOCK</b>				
TW959 (x1)+TW961 (x1)	1 + 1	Suits Top Front Pin (1 each req'd)		Pin Style Bushing
412772	1	Suits Bottom Front Eye		Eyering Bushing
ADJ00191	1	Suits Top Rear Eyering		Suit Foam Cell Shocks
4W-SPF420-02	1	Suits Bottom Rear Eyering		Suit Foam Cell Shocks
230100	1	Suits Top Rear Eyering		Suit 40mm Adjustable Shocks
230002	1	Suits Bottom Rear Eyering		Suit 40mm Adjustable Shocks

Vehicle fitment sheet must be completed when suspension fitted. Failure to do so may affect warranty.  
Fitment sheet can be found on page 200 of this catalogue



# FORD RANGER 12/06-10/11 PJ & PK, 2.5L & 3.0L

## FRONT SUSPENSION

**ESTIMATED LIFT: 45 mm**

PART NO.	QTY	DESCRIPTION	RRP inc GST	NOTES
<b>SHOCK ABSORBERS</b>				
FC42051B	2	41mm Foam Cell Shock		Suits up to 45mm Lift
TDSK-020	1	Shock Mount Strengthening Kit		Top Pin Mount Bracket
<b>Please Note: - Failure to fit TDSK-020 will cause top mount failure. Fitting instructions at <a href="http://toughdog.com.au">toughdog.com.au</a></b>				
<b>TORSION BARS</b>				
4WTB-1440	1	Replacement Torsion Bars		27mm/1028mm
<b>Adjust Torsion bars after fitting shocks - Ensure a minimum of 60mm Droop is Maintained</b>				

## REAR SUSPENSION

<b>SHOCK ABSORBERS</b>				
BD1232T	2	35mm Nitrogen Gas Shock		Suits Up to 45mm Lift
FC41232	2	41mm Foam Cell Shock		Suits Up to 45mm Lift
BM401232	2	40mm 9 Stage Adjustable		Suits Up to 45mm Lift
<b>LEAF SPRINGS</b>				
FS368C	2	0-300kg Load		45mm Lift
FS368L	2	<b>CONSTANT</b> 300Kg Load		45mm Lift
<b>COMPONENTS</b>				
TDUK-069	1	Urethane Shackle Bushing Kit		
TDUB-040	2	U-Bolt Kit		Suits FS368C only
TDUB-039	2	U-Bolt Kit		Suits FS368L only
TDGS-386/1	1	Greasable Shackle Kit		
TDGP-668	1	Greasable Pin Kit		
<b>AIR ASSIST BAGS</b>				
TDAA-101	1	Bellows bag kit		Suits 45mm Lift

## COMPLETE KIT PRICE REFERENCE

SHOCK CHOICE	SPRING CHOICE	RRP inc GST	CONTENTS
Foam Cell Front Nitro gas Rear	0-300KG		<p><b>Includes</b>            2 x Leaf Springs            4 x Shocks            1 x Urethane Kit            2 x U-Bolt Kits            1 x Shock Mount Kit</p>
41mm Foam Cell	0-300KG		
	Constant 300kg		
Foam Cell Front Adjustable Rear	0-300KG		
	Constant 300kg		

Freight should be added where required. When determining spring choice, include only permanent accessories & weights. Towing requirements are not included in constant load determination

# FORD

## RANGER

11/2011 - 08/2018

PX & PX II- All Models



### FRONT SUSPENSION

**ESTIMATED LIFT: 40mm**

PART NO.	QTY	DESCRIPTION	RRP inc GST	NOTES
<b>SHOCK ABSORBERS</b>				
FC404500	2	40mm Foam Cell Strut		
BM404500	2	40mm Adjustable Strut		9 Stage Adjustable
<b>COIL SPRINGS</b>				
TDC451	2	40mm Lift Spring		Petrol/Diesel/Bar
TDC451HL	2	40mm Lift Spring		Petrol/Diesel/Bar/Winch
<b>COMPLETE STRUT ASSEMBLY</b>				
MAZ-001	2	BM404500/TDC451		Petrol/Diesel/Bar
MAZ-002	2	BM404500/TDC451HL		Petrol/Diesel/Bar/Winch
MAZ-003	2	FC404500/TDC451		Petrol/Diesel/Bar
MAZ-004	2	FC404500/TDC451HL		Petrol/Diesel/Bar/Winch
<b>REPLACEMENT STRUT TOP</b>				
MAZ-4051	2	Strut Top		Replacement Strut Top

### REAR SUSPENSION

<b>SHOCK ABSORBERS</b>				
BD1232T	2	35mm Nitrogen Gas Shock		Up to 40mm Lift <b>(For Comfort)</b>
FC41232	2	41mm Foam Cell Shock		Suits Up to 40mm Lift
BM401232	2	40mm 9 Stage Adjustable		Suits Up to 40mm Lift
<b>LEAF SPRINGS</b>				
FS369C	2	0-300kg Load		40mm Lift
FS369L	2	<b>CONSTANT</b> 300Kg Load		40mm Lift
FS369LL	2	<b>CONSTANT</b> 500Kg Load		40mm Lift
<b>COMPONENTS</b>				
TDUK-070	1	Urethane Shackle Bushing Kit		
TDUB-039	2	U-Bolt Kit		Suits FS369L & LL Spring
TDUB-040	2	U-Bolt Kit		Suits FS369C Spring Only
TDGS-390	1	Greasable Shackle Kit		
TDGP-668	1	Greasable Pin Kit		
TDSP-007	1	Transmission Spacer Kit		Must Be fitted to All Lift Kits
<b>AIR ASSIST BAGS</b>				
TDAA-102	1	Bellows bag kit		Suits 40mm Lift

### REPLACEMENT BUSHINGS

QUANTITY PER SHOCK				
MAZ-4051	1	Replacement Strut Top		Available As Complete Unit Only
ADJ00305	1	Suits Bottom Front Eye		Eyering Bonded Bushing
ADJ00191	1	Suits Top Rear Eyering		Suit Foam Cell Shocks
4W-SPF420-02	1	Suits Bottom Rear Eyering		
230100	1	Suits Top Rear Eyering		Suit 40mm Adjustable Shocks
230002	1	Suits Bottom Rear Eyering		

Vehicle fitment sheet must be completed when suspension fitted. Failure to do so may affect warranty.

Fitment sheet can be found on page 200 of this catalogue

**Note: Transmission spacer fitting instructions available at [toughdog.com.au](http://toughdog.com.au)**

# FORD RANGER

11/2011 - 08/2018  
PX & PXII - All Models

*35mm Nitro Gas shocks should be used when extra comfort is desired in vehicles carrying little to no load. They are not suitable for heavy load carrying applications*

SHOCK CHOICE	SPRING CHOICE	RRP inc GST	CONTENTS
<p><b>Foam Cell Struts Require Assembly</b></p> <p><b>Includes</b>            2x Front Struts            2x Rear Shocks            2x Front Coils            2x Leaf Springs            1x Urethane Kit            2x U-Bolt Kits            1x Transmission Spacer</p>	<p><b>FS369C</b> (Foam Front Gas Rear)</p> <p><b>FS369C</b> (Foam Cell All)</p> <p><b>FS369L</b> CONSTANT 300KG</p> <p><b>FC369LL</b> CONSTANT 500KG</p>		
<p><b>Foam Cell Complete Assembly Struts</b></p> <p><b>Includes</b>            2x Front Strut Assy            2x Rear Shocks            2x Leaf Springs            1x Urethane Kit            2x U-Bolt Kits            1x Transmission Space</p>	<p><b>FS369C</b> (Foam Front Gas Rear)</p> <p><b>FS369C</b> (Foam Cell All)</p> <p><b>FS369L</b> CONSTANT 300KG</p> <p><b>FS369LL</b> CONSTANT 500KG</p>		
<p><b>40mm Adjustable Struts Require Assembly</b></p> <p><b>Includes</b>            2x Front Struts            2x Rear Shocks            2x Front Coils            2x Leaf Springs            1x Urethane Kit            2x U-Bolt Kits            1x Transmission Spacer</p>	<p><b>FS369C</b> 0-300KG</p> <p><b>FS369L</b> CONSTANT 300KG</p> <p><b>FS369LL</b> CONSTANT 500KG</p>		
<p><b>40mm Adjustable Complete Assembly Struts</b></p> <p><b>Includes</b>            2x Front Strut Assy            2x Rear Shocks            2x Leaf Springs            1x Urethane Kit            2x U-Bolt Kits            1x Transmission Spacer</p>	<p><b>FS369C</b> 0-300KG</p> <p><b>FS369L</b> CONSTANT 300KG</p> <p><b>FS369LL</b> CONSTANT 500KG</p>		

*Freight should be added where required. When determining spring choice, include only permanent accessories & weights. Towing requirements are not included in constant load determination*

# FORD

## RANGER

08/2018 on  
PXIII All Models



### FRONT SUSPENSION

**ESTIMATED LIFT: 40mm**

PART NO.	QTY	DESCRIPTION	RRP inc GST	NOTES
<b>SHOCK ABSORBERS</b>				
FC404520	2	40mm Foam Cell Strut		
BM404520	2	40mm Adjustable Strut		9 Stage Adjustable
<b>COIL SPRINGS</b>				
TDC455	2	40mm Lift Spring		Petrol/Diesel/Bar
TDC455HL	2	40mm Lift Spring		Petrol/Diesel/Bar/Winch
<b>COMPLETE STRUT ASSEMBLY</b>				
FOR-001	2	BM404520/TDC455		Petrol/Diesel/Bar
FOR-002	2	BM404520/TDC455HL		Petrol/Diesel/Bar/Winch
FOR-003	2	FC404520/TDC455		Petrol/Diesel/Bar
FOR-004	2	FC404520/TDC455HL		Petrol/Diesel/Bar/Winch
<b>REPLACEMENT STRUT TOP</b>				
FOR-4520	2	Strut Top		Replacement Strut Top

### REAR SUSPENSION

<b>SHOCK ABSORBERS</b>				
BD1232T	2	35mm Nitrogen Gas Shock		Up to 40mm Lift <b>(For Comfort)</b>
FC41232	2	41mm Foam Cell Shock		Suits Up to 40mm Lift
BM401232	2	40mm 9 Stage Adjustable		Suits Up to 40mm Lift
<b>LEAF SPRINGS</b>				
FS369C	2	0-300kg Load		40mm Lift
FS369L	2	<b>CONSTANT</b> 300Kg Load		40mm Lift
FS369LL	2	<b>CONSTANT</b> 500Kg Load		40mm Lift
<b>COMPONENTS</b>				
TDUK-070	1	Urethane Shackle Bushing Kit		
TDUB-039	2	U-Bolt Kit		Suits FS369L & LL Spring
TDUB-040	2	U-Bolt Kit		Suits FS369C Spring Only
TDGS-390	1	Greasable Shackle Kit		
TDGP-668	1	Greasable Pin Kit		
TDSP-007	1	Transmission Spacer Kit		Must Be fitted to All Lift Kits
<b>AIR ASSIST BAGS</b>				
TDAA-102	1	Bellows bag kit		Suits 40mm Lift

### REPLACEMENT BUSHINGS

QUANTITY PER SHOCK				
FOR-4520	1	Replacement Strut Top		Available As Complete Unit Only
ADJ00306	1	Suits Bottom Front Eye		Eyering Bonded Bushing
ADJ00191	1	Suits Top Rear Eyering		Suit Foam Cell Shocks
4W-SPF420-02	1	Suits Bottom Rear Eyering		
230100	1	Suits Top Rear Eyering		Suit 40mm Adjustable Shocks
230002	1	Suits Bottom Rear Eyering		





Vehicle fitment sheet must be completed when suspension fitted. Failure to do so may affect warranty.

Fitment sheet can be found on page 200 of this catalogue

# FORD RANGER 08/2018 on PXIII - All Models

**Note: Transmission spacer  
fitting instructions available  
at [toughdog.com.au](http://toughdog.com.au)**

*35mm Nitro Gas shocks should be used when extra comfort is desired in vehicles carrying little to no load.  
They are not suitable for heavy load carrying applications*

SHOCK CHOICE	SPRING CHOICE	RRP inc GST	CONTENTS
<p><b>Foam Cell Struts Require Assembly</b> <b>Includes</b> 2x Front Struts 2x Rear Shocks 2x Front Coils 2x Leaf Springs 1x Urethane Kit 2x U-Bolt Kits 1x Transmission Spacer</p>	<p><b>FS369C</b> (Foam Front Gas Rear)</p> <p><b>FS369C</b> (Foam Cell All)</p> <p><b>FS369L</b> <b>CONSTANT 300KG</b></p> <p><b>FC369LL</b> <b>CONSTANT 500KG</b></p>		
<p><b>Foam Cell Complete Assembly Struts</b> <b>Includes</b> 2x Front Strut Assy 2x Rear Shocks 2x Leaf Springs 1x Urethane Kit 2x U-Bolt Kits 1x Transmission Space</p>	<p><b>FS369C</b> (Foam Front Gas Rear)</p> <p><b>FS369C</b> (Foam Cell All)</p> <p><b>FS369L</b> <b>CONSTANT 300KG</b></p> <p><b>FS369LL</b> <b>CONSTANT 500KG</b></p>		
<p><b>40mm Adjustable Struts Require Assembly</b> <b>Includes</b> 2x Front Struts 2x Rear Shocks 2x Front Coils 2x Leaf Springs 1x Urethane Kit 2x U-Bolt Kits 1x Transmission Spacer</p>	<p><b>FS369C</b> 0-300KG</p> <p><b>FS369L</b> <b>CONSTANT 300KG</b></p> <p><b>FS369LL</b> <b>CONSTANT 500KG</b></p>		
<p><b>40mm Adjustable Complete Assembly Struts</b> <b>Includes</b> 2x Front Strut Assy 2x Rear Shocks 2x Leaf Springs 1x Urethane Kit 2x U-Bolt Kits 1x Transmission Spacer</p>	<p><b>FS369C</b> 0-300KG</p> <p><b>FS369L</b> <b>CONSTANT 300KG</b></p> <p><b>FS369LL</b> <b>CONSTANT 500KG</b></p>		

*Freight should be added where required. When determining spring choice, include only permanent accessories & weights. Towing requirements are not included in constant load determination*

# GREAT WALL

## UTE (WINGLE, SAILOR)

6/09 On

V200, 240, 2.4L



### FRONT SUSPENSION

**ESTIMATED LIFT: 45 mm**

PART NO.	QTY	DESCRIPTION	RRP inc GST	NOTES
<b>SHOCK ABSORBERS</b>				
FC42019B	2	41mm Foam Cell Shock		Suits up to 45mm Lift
<b>TORSION BARS</b>				
4WTB-1559	1	Replacement Torsion Bars		30mm/1145mm
<b>Adjust Torsion bars after fitting shocks - Ensure a minimum of 60mm Droop is Maintained</b>				

### REAR SUSPENSION

<b>SHOCK ABSORBERS</b>				
BD1382T	2	35mm Nitrogen Gas Shock		Suits OE Height
FC41382	2	41mm Foam Cell Shock		
BM401382	2	40mm 9 Stage Adjustable		
BD1388T	2	35mm Nitrogen Gas Shock		Suits 45mm Lift
FC41388	2	41mm Foam Cell Shock		
BM401388	2	40mm 9 Stage Adjustable		
<b>LEAF SPRINGS</b>				
FS213	2	0-300kg Load		45mm Lift
FS213H	2	<b>CONSTANT</b> 300Kg Load		45mm Lift
<b>COMPONENTS</b>				
TDUK-065	1	Urethane Shackle Bushing Kit		
TDUB-039	2	U-Bolt Kit		
TDGS-386	1	Greasable Shackle Kit		
TDGP-668	1	Greasable Pin Kit		

### REPLACEMENT BUSHINGS

QUANTITY PER SHOCK				
TW959	2	Suits Top Front Pin		Pin Style Bushing
412772	1	Suits Bottom Front Eying		Eying Bushing
404702	2	Suits Top & Bottom Rear Eying		Eying Bushing

### COMPLETE KIT PRICE REFERENCE

SHOCK CHOICE	SPRING CHOICE	RRP inc GST	CONTENTS
Foam Cell Front Nitro gas Rear	0-300KG Constant 300kg		
41mm Foam Cell	0-300KG Constant 300kg		
Foam Cell Front Adjustable Rear	0-300KG Constant 300kg		
<b>Includes</b> 2 x Leaf Springs    4 x Shocks 1 x Urethane Kits    2 x U-Bolt Kits			

Vehicle fitment sheet must be completed when suspension fitted. Failure to do so may affect warranty.  
Fitment sheet can be found on page 200 of this catalogue





# GREAT WALL

## 4 DOOR (HOVER, SAFE, HAVAL)

05- On  
X240

### FRONT SUSPENSION

**ESTIMATED LIFT: 30 mm**

PART NO.	QTY	DESCRIPTION	RRP inc GST	NOTES
<b>SHOCK ABSORBERS</b>				
FC42019B	2	41mm Foam Cell Shock		Suits up to 30mm Lift
<b>TORSION BARS</b>				
4WTB-1559	1	Replacement Torsion Bars		30mm/1145mm
<b>Adjust Torsion bars after fitting shocks - Ensure a minimum of 60mm Droop is Maintained</b>				

### REAR SUSPENSION

<b>SHOCK ABSORBERS</b>				
FC41460	2	41mm Foam Cell Shock		Suits Up to 30mm Lift
BM401460	2	40mm 9 Stage Adjustable		Suits Up to 30mm Lift
<b>COIL SPRINGS</b>				
TDC045	2	0-300kg Load		30mm Lift

### REPLACEMENT BUSHINGS

QUANTITY PER SHOCK				
TW959	2	Suits Top Front Pin		Pin Style Bushing
412772	1	Suits Bottom Front Eye		Eyering Bushing
TW959	2	Suits Top & Bottom Rear Pin		Pin Style Bushing
TW038/16	1	Suits Bottom Rear Eyering		Eyering Bushing

### COMPLETE KIT PRICE REFERENCE

SHOCK CHOICE	SPRING CHOICE	RRP inc GST	CONTENTS
41mm Foam Cell	0-300KG		
Foam Cell Front Adjustable Rear	0-300KG		
Includes 2 x Coil Springs      4 x Shocks			

Freight should be added where required. When determining spring choice, include only permanent accessories & weights. Towing requirements are not included in constant load determination

# HOLDEN

## FRONTERA LWB & SWB

10/95-99 & 3/99-04

2 DOOR & 4 DOOR, 3.2L V6, 2.2L TDI



### FRONT SUSPENSION

**ESTIMATED LIFT: 40 mm**

PART NO.	QTY	DESCRIPTION	RRP inc GST	NOTES
<b>SHOCK ABSORBERS</b>				
FC42019B	2	41mm Foam Cell Shock		Suits up to 40mm Lift
<b>TORSION BARS</b>				
4WTB-1559	1	Replacement Torsion Bars		30mm/1145mm - 3/99-04 ONLY
<b>Adjust Torsion bars after fitting shocks - Ensure a minimum of 60mm Droop is Maintained</b>				

### REAR SUSPENSION

<b>SHOCK ABSORBERS</b>				
FC41200	2	41mm Foam Cell Shock		Check Mounts before ordering Suits Eye/Eye Vehicles
BM401200	2	40mm 9 Stage Adjustable		
FC41201B	2	41mm Foam Cell Shock		Check Mounts before ordering Suits Pin/Eye Vehicles
BM401201	2	40mm 9 Stage Adjustable		
<b>COIL SPRINGS</b>				
TDC290	2	0-300kg Load		OE Height (10/95-99 ONLY)
TDC267	2	0-300kg Load		40mm Lift (10/95-99 ONLY)
TDC267	2	0-300kg Load		35mm Lift (3/99-04 ONLY)
TDC267H	2	<b>CONSTANT</b> 300Kg Load		35mm Lift (3/99-04 ONLY)

### COMPLETE KIT PRICE REFERENCE

SHOCK CHOICE	SPRING CHOICE	RRP inc GST	CONTENTS
41mm Foam Cell	0-300KG Constant 300kg		
Foam Cell Front Adjustable Rear	0-300KG Constant 300kg		
<b>Includes</b> 2 x Coil Springs    4 x Shocks			

Vehicle fitment sheet must be completed when suspension fitted. Failure to do so may affect warranty.  
Fitment sheet can be found on page 200 of this catalogue



# HOLDEN

## JACKAROO, ISUZU TROOPER

11/81-86  
UBS13, 16, 52L

### FRONT SUSPENSION

**ESTIMATED LIFT: 45 mm**

PART NO.	QTY	DESCRIPTION	RRP inc GST	NOTES
<b>SHOCK ABSORBERS</b>				
BD2057T	2	35mm Nitrogen Gas Shock		Suits up to 45mm Lift
FC42057B	2	41mm Foam Cell Shock		Suits up to 45mm Lift
<b>TORSION BARS</b>				
4WTB-1546	1	Replacement Torsion Bars		26mm/926mm
<b>Adjust Torsion bars after fitting shocks - Ensure a minimum of 60mm Droop is Maintained</b>				

### REAR SUSPENSION

<b>SHOCK ABSORBERS</b>				
BD1382T	2	35mm Nitrogen Gas Shock		Suits OE Height
FC41382	2	41mm Foam Cell Shock		
BM401382	2	40mm 9 Stage Adjustable		
BD1388T	2	35mm Nitrogen Gas Shock		Suits 45mm Lift
FC41388	2	41mm Foam Cell Shock		
BM401388	2	40mm 9 Stage Adjustable		
<b>LEAF SPRINGS</b>				
FS113	2	0-300kg Load		45mm Lift
FS113H	2	<b>CONSTANT</b> 300Kg Load		45mm Lift
<b>COMPONENTS</b>				
TDUK-004	1	Urethane Shackle Bushing Kit		
TDUB-006	2	U-Bolt Kit		
TDGP-668	1	Greasable Pin Kit		

### REPLACEMENT BUSHINGS

QUANTITY PER SHOCK				
TW959	2	Suits Top Front Pin		Pin Style Bushing
412772	1	Suits Bottom Front Eye		Eyering Bushing
404702	2	Suits Top & Bottom Rear Eye		Eyering Bushing

### COMPLETE KIT PRICE REFERENCE

SHOCK CHOICE	SPRING CHOICE	RRP inc GST	CONTENTS
<b>35mm Nitro Gas</b>	<b>0-300KG</b>		
<b>41mm Foam Cell</b>	<b>0-300KG</b>		
<b>Foam Cell Front Adjustable Rear</b>	<b>0-300KG</b>		
	<b>Constant 300kg</b>		
<b>Includes</b>			
2 x Leaf Springs 1 x Urethane Kits		4 x Shocks 2 x U-Bolt Kits	

Freight should be added where required. When determining spring choice, include only permanent accessories & weights. Towing requirements are not included in constant load determination

# HOLDEN

## JACKAROO, ISUZU TROOPER

11/86-92  
UBS16, 17, 52, 55



### FRONT SUSPENSION

**ESTIMATED LIFT: 45 mm**

PART NO.	QTY	DESCRIPTION	RRP inc GST	NOTES
<b>SHOCK ABSORBERS</b>				
BD2057T	2	35mm Nitrogen Gas Shock		Suits up to 45mm Lift
FC42057B	2	41mm Foam Cell Shock		Suits up to 45mm Lift
<b>TORSION BARS</b>				
4WTB-1548	1	Replacement Torsion Bars		26mm/997mm
<b>Adjust Torsion bars after fitting shocks - Ensure a minimum of 60mm Droop is Maintained</b>				

### REAR SUSPENSION

<b>SHOCK ABSORBERS</b>				
BD1105T	2	35mm Nitrogen Gas Shock		Suits OE Height
FC41105	2	41mm Foam Cell Shock		
BM401105	2	40mm 9 Stage Adjustable		
BD1106TB	2	35mm Nitrogen Gas Shock		Suits 45mm Lift
FC41106	2	41mm Foam Cell Shock		
BM401106	2	40mm 9 Stage Adjustable		
<b>LEAF SPRINGS</b>				
FS113	2	0-300kg Load		45mm Lift
FS113H	2	<b>CONSTANT</b> 300Kg Load		45mm Lift
<b>COMPONENTS</b>				
TDUK-004	1	Urethane Shackle Bushing Kit		
TDUB-006	2	U-Bolt Kit		
TDGP-668	1	Greasable Pin Kit		

### REPLACEMENT BUSHINGS

QUANTITY PER SHOCK				
TW959	2	Suits Top Front Pin		Pin Style Bushing
412772	1	Suits Bottom Front Eye		Eyering Bushing
404702	2	Suits Top & Bottom Rear Eye		Eyering Bushing

### COMPLETE KIT PRICE REFERENCE

SHOCK CHOICE	SPRING CHOICE	RRP inc GST	CONTENTS
35mm Nitro Gas	0-300KG		
41mm Foam Cell	0-300KG Constant 300kg		
Foam Cell Front Adjustable Rear	0-300KG Constant 300kg		
<b>Includes</b>			
2 x Leaf Springs 1 x Urethane Kits		4 x Shocks 2 x U-Bolt Kits	

Vehicle fitment sheet must be completed when suspension fitted. Failure to do so may affect warranty.  
Fitment sheet can be found on page 200 of this catalogue

# HOLDEN

## JACKAROO, MONTEREY

5/92-98 & 2/98-04  
UBS26, 69, 73 (INC WIDE BODY)

### FRONT SUSPENSION

**ESTIMATED LIFT: 40 mm**

PART NO.	QTY	DESCRIPTION	RRP inc GST	NOTES
<b>SHOCK ABSORBERS</b>				
FC42019B	2	41mm Foam Cell Shock		Suits up to 40mm Lift
<b>TORSION BARS</b>				
4WTB-1549	1	Replacement Torsion Bars		29.3mm/1220mm
<b>Adjust Torsion bars after fitting shocks - Ensure a minimum of 60mm Droop is Maintained</b>				

### REAR SUSPENSION

<b>SHOCK ABSORBERS</b>				
FC41200	2	41mm Foam Cell Shock		Suits up to 40mm Lift
BM401200	2	40mm 9 Stage Adjustable		Suits up to 40mm Lift
<b>COIL SPRINGS</b>				
TDC267	2	0-300kg Load		40mm Lift
TDC267H	2	<b>CONSTANT</b> 300Kg Load		Suit UBS25, 69
TDC267HH	2	<b>CONSTANT</b> 500Kg Load		
TDC267H	2	0-300kg Load		40mm Lift
TDC267HH	2	<b>CONSTANT</b> 300Kg Load		Suit UBS26, 73 Wide Body

### REPLACEMENT BUSHINGS

QUANTITY PER SHOCK				
TW959	2	Suits Top Front Pin		Pin Style Bushing
412772	1	Suits Bottom Front Eye		Eyering Bushing

### COMPLETE KIT PRICE REFERENCE

SHOCK CHOICE	SPRING CHOICE	RRP inc GST	CONTENTS
41mm Foam Cell	ANY		
Foam Cell Front Adjustable Rear	ANY		
<b>Includes</b> 2 x Coil Springs      4 x Shocks			

Freight should be added where required. When determining spring choice, include only permanent accessories & weights. Towing requirements are not included in constant load determination

# HOLDEN

## RODEO

1/81-88

KB4, KBD4



### FRONT SUSPENSION

**ESTIMATED LIFT: 40 mm**

PART NO.	QTY	DESCRIPTION	RRP inc GST	NOTES
<b>TORSION BARS</b>				
4WTB-1536	1	Replacement Torsion Bars		26mm/927mm (1/81-83 ONLY)
4WTB-1546	1	Replacement Torsion Bars		26mm/926mm (83-88 ONLY)
<b>Adjust Torsion bars after fitting shocks - Ensure a minimum of 60mm Droop is Maintained</b>				

### REAR SUSPENSION

<b>SHOCK ABSORBERS</b>				
BD1382T	2	35mm Nitrogen Gas Shock		Suits OE Height
FC41382	2	41mm Foam Cell Shock		
BM401382	2	40mm 9 Stage Adjustable		
BD1388T	2	35mm Nitrogen Gas Shock		Suits 40mm Lift
FC41388	2	41mm Foam Cell Shock		
BM401388	2	40mm 9 Stage Adjustable		
<b>LEAF SPRINGS</b>				
FS113	2	0-300kg Load		40mm Lift
FS113H	2	<b>CONSTANT</b> 300Kg Load		40mm Lift
FS113HM	2	<b>CONSTANT</b> 500Kg Load		40mm Lift
<b>COMPONENTS</b>				
TDUK-004	1	Urethane Shackle Bushing Kit		
TDUB-006	2	U-Bolt Kit		
TDGS-386	1	Greasable Shackle Kit		
TDGP-668	1	Greasable Pin Kit		

### REPLACEMENT BUSHINGS

<b>QUANTITY PER SHOCK</b>				
404702	2	Suits Top & Bottom Rear Eye		Eyering Bushing

Vehicle fitment sheet must be completed when suspension fitted. Failure to do so may affect warranty.  
Fitment sheet can be found on page 200 of this catalogue



# HOLDEN

**RODEO**

1/81-88

KB4, KBD4

## COMPLETE KIT PRICE REFERENCE

SHOCK CHOICE	SPRING CHOICE	RRP inc GST	CONTENTS
<p><b>35mm Nitro Gas Rear</b></p> <p><u>Includes</u>                      2x Rear Shocks                      2x Leaf Springs                      1x Urethane Kit                      2x U-Bolt Kits</p>	<p>FS113                      0-300KG Spring</p> <p>FS113H                      CONSTANT 300KG Spring</p>		
<p><b>41mm Foam Cell Rear</b></p> <p><u>Includes</u>                      2x Rear Shocks                      2x Leaf Springs                      1x Urethane Kit                      2x U-Bolt Kits</p>	<p>FS113                      0-300KG Spring</p> <p>FS113H                      CONSTANT 300KG Spring</p> <p>FS113HM                      CONSTANT 500KG Spring</p>		
<p><b>40mm Adjustable Rear</b></p> <p><u>Includes</u>                      2x Rear Shocks                      2x Leaf Springs                      1x Urethane Kit                      2x U-Bolt Kits</p>	<p>FS113                      0-300KG Spring</p> <p>FS113H                      CONSTANT 300KG Spring</p> <p>FS113HM                      CONSTANT 500KG Spring</p>		

Freight should be added where required. When determining spring choice, include only permanent accessories & weights. Towing requirements are not included in constant load determination

# HOLDEN

## RODEO

8/88-03

TFS, G3, G6, R7, R9



### FRONT SUSPENSION

**ESTIMATED LIFT: 40 mm**

PART NO.	QTY	DESCRIPTION	RRP inc GST	NOTES
<b>SHOCK ABSORBERS</b>				
BD2057T	2	35mm Nitrogen Gas Shock		Suits up to 40mm Lift
<b>TORSION BARS</b>				
4WTB-1548	1	Replacement Torsion Bars		26mm/997mm - 36mm Spline
4WTB-1566	1	Replacement Torsion Bars		27mm/998mm - 33mm Spline
<b>Check Spline &amp; Diameter prior to ordering</b>				
<b>Adjust Torsion bars after fitting shocks - Ensure a minimum of 60mm Droop is Maintained</b>				

### REAR SUSPENSION

<b>SHOCK ABSORBERS</b>				
BD1382T	2	35mm Nitrogen Gas Shock		Suits OE Height
FC41382	2	41mm Foam Cell Shock		
BM401382	2	40mm 9 Stage Adjustable		
BD1388T	2	35mm Nitrogen Gas Shock		Suits 40mm Lift
FC41388	2	41mm Foam Cell Shock		
BM401388	2	40mm 9 Stage Adjustable		
<b>LEAF SPRINGS</b>				
<b>Check No. of Leaves - Rare special editions have heavier leaf packs from factory</b>				
FS113	2	0-300kg Load		40mm Lift
FS113H	2	<b>CONSTANT</b> 300Kg Load		40mm Lift
FS113HM	2	<b>CONSTANT</b> 500Kg Load		40mm Lift
<b>COMPONENTS</b>				
TDUK-065	1	Urethane Shackle Bushing Kit		
TDUB-005	2	U-Bolt Kit		
TDGS-386	1	Greasable Shackle Kit		
TDGP-668	1	Greasable Pin Kit		

### REPLACEMENT BUSHINGS

QUANTITY PER SHOCK				
TW959	2	Suits Top Front Pin		Pin Style Bushing
412772	1	Suits Bottom Front Eye		Eyering Bushing
404702	2	Suits Top & Bottom Rear Eye		Eyering Bushing

Vehicle fitment sheet must be completed when suspension fitted. Failure to do so may affect warranty.  
Fitment sheet can be found on page 200 of this catalogue





# HOLDEN

**RODEO**

8/88-03

TFS, G3, G6, R7, R9

## COMPLETE KIT PRICE REFERENCE

SHOCK CHOICE	SPRING CHOICE	RRP inc GST	CONTENTS
<p><b>35mm Nitro Gas</b></p> <p><u>Includes</u>                      2x Front Shocks                      2x Rear Shocks                      2x Leaf Springs                      1x Urethane Kit                      2x U-Bolt Kits</p>	<p>FS113                      0-300KG Spring</p> <p>FS113H                      CONSTANT 300KG                      Spring</p>		
<p><b>Nitro Gas Front                      Foam Cell Rear</b></p> <p><u>Includes</u>                      2x Front Shocks                      2x Rear Shocks                      2x Leaf Springs                      1x Urethane Kit                      2x U-Bolt Kits</p>	<p>FS113                      0-300KG Spring</p> <p>FS113H                      CONSTANT 300KG                      Spring</p> <p>FS113HM                      CONSTANT 500KG                      Spring</p>		
<p><b>Nitro Gas Front                      Adjustable Rear</b></p> <p><u>Includes</u>                      2x Front Shocks                      2x Rear Shocks                      2x Leaf Springs                      1x Urethane Kit                      2x U-Bolt Kits</p>	<p>FS113                      0-300KG Spring</p> <p>FS113H                      CONSTANT 300KG                      Spring</p> <p>FS113HM                      CONSTANT 500KG                      Spring</p>		

Freight should be added where required. When determining spring choice, include only permanent accessories & weights. Towing requirements are not included in constant load determination

# HOLDEN

## RODEO & COLORADO

2/03-2012  
RA-RC



### FRONT SUSPENSION

**ESTIMATED LIFT: 45 mm**

PART NO.	QTY	DESCRIPTION	RRP inc GST	NOTES
<b>SHOCK ABSORBERS</b>				
FC42019B	2	41mm Foam Cell Shock		Suits up to 45mm Lift
<b>TORSION BARS</b>				
4WTB-1559	1	Replacement Torsion Bars		30mm/1145mm
<b>Adjust Torsion bars after fitting shocks - Ensure a minimum of 60mm Droop is Maintained</b>				

### REAR SUSPENSION

<b>SHOCK ABSORBERS</b>				
BD1382T	2	35mm Nitrogen Gas Shock		Suits OE Height
FC41382	2	41mm Foam Cell Shock		
BM401382	2	40mm 9 Stage Adjustable		
BD1388T	2	35mm Nitrogen Gas Shock		Suits 45mm Lift
FC41388	2	41mm Foam Cell Shock		
BM401388	2	40mm 9 Stage Adjustable		
<b>LEAF SPRINGS</b>				
FS213	2	0-300kg Load		45mm Lift
FS213H	2	<b>CONSTANT</b> 300Kg Load		45mm Lift
<b>COMPONENTS</b>				
TDUK-065	1	Urethane Shackle Bushing Kit		
TDUB-039	2	U-Bolt Kit		
TDGS-386	1	Greasable Shackle Kit		
TDGP-668	1	Greasable Pin Kit		
<b>AIR ASSIST BAGS</b>				
TDAA-103	1	Bellows bag kit		Suits 45mm Lift

### REPLACEMENT BUSHINGS

QUANTITY PER SHOCK				
TW959	2	Suits Top Front Pin		Pin Style Bushing
412772	1	Suits Bottom Front Eye		Eyering Bushing
404702	2	Suits Top & Bottom Rear Eye		Eyering Bushing



Vehicle fitment sheet must be completed when suspension fitted. Failure to do so may affect warranty.  
Fitment sheet can be found on page 200 of this catalogue

# HOLDEN

## RODEO & COLORADO

2/03-2012  
RA-RC

### COMPLETE KIT PRICE REFERENCE

SHOCK CHOICE	SPRING CHOICE	RRP inc GST	CONTENTS
<p><b>Foam Cell Front Nitro Gas Rear</b></p> <p><u>Includes</u> 2x Front Shocks 2x Rear Shocks 2x Leaf Springs 1x Urethane Kit 2x U-Bolt Kits</p>	<p><b>FS213 0-300KG Spring</b></p>		
<p><b>41mm Foam Cell</b></p> <p><u>Includes</u> 2x Front Shocks 2x Rear Shocks 2x Leaf Springs 1x Urethane Kit 2x U-Bolt Kits</p>	<p><b>FS213 0-300KG Spring</b></p> <p><b>FS213H CONSTANT 300KG Spring</b></p>		
<p><b>Foam Cell Front Adjustable Rear</b></p> <p><u>Includes</u> 2x Front Shocks 2x Rear Shocks 2x Leaf Springs 1x Urethane Kit 2x U-Bolt Kits</p>	<p><b>FS213 0-300KG Spring</b></p> <p><b>FS213H CONSTANT 300KG Spring</b></p>		

Freight should be added where required. When determining spring choice, include only permanent accessories & weights. Towing requirements are not included in constant load determination

# HOLDEN

## COLORADO

11/11 On

RG, MMU142, GM1700



### FRONT SUSPENSION

**ESTIMATED LIFT: 40mm**

PART NO.	QTY	DESCRIPTION	RRP inc GST	NOTES
<b>SHOCK ABSORBERS</b>				
FC404200	2	40mm Foam Cell Strut		
BM404200	2	40mm Adjustable Strut		9 Stage Adjustable
<b>COIL SPRINGS</b>				
TDC270	2	40mm Lift Spring		Petrol/Diesel/Bar
TDC974	2	40mm Lift Spring		Petrol/Diesel/Bar/Winch
<b>COMPLETE STRUT ASSEMBLY</b>				
HOL-001	2	BM404200/TDC270		Petrol/Diesel/Bar
HOL-002	2	BM404200/TDC974		Petrol/Diesel/Bar/Winch
HOL-003	2	FC404200/TDC270		Petrol/Diesel/Bar
HOL-004	2	FC404200/TDC974		Petrol/Diesel/Bar/Winch
<b>REPLACEMENT STRUT TOP - Strut top special info sheet at <a href="http://toughdog.com.au">toughdog.com.au</a></b>				
TOY-1081	2	Strut Top		Replacement Strut Top

### REAR SUSPENSION

<b>SHOCK ABSORBERS</b>				
BD1382T	2	35mm Nitrogen Gas Shock		Suits Up to 40mm Lift
FC41382	2	41mm Foam Cell Shock		Suits Up to 40mm Lift
BM401382	2	40mm 9 Stage Adjustable		Suits Up to 40mm Lift
<b>LEAF SPRINGS</b>				
FS214C	2	0-300kg Load		40mm Lift
FS214L	2	<b>CONSTANT</b> 300Kg Load		40mm Lift
FS214LL	2	<b>CONSTANT</b> 500Kg Load		40mm Lift
<b>COMPONENTS</b>				
TDUK-071	1	Urethane Shackle Bushing Kit		
TDUB-016	2	U-Bolt Kit		
TDGS-391	1	Greasable Shackle Kit		
TDGP-668	1	Greasable Pin Kit		
TDSK-021	1	Handbrake Relocation kit		Req'd for MY17 vehicles
<b>Handbrake Relocation kit is required for all vehicles MY17 onwards (06/16 release onward)</b>				
<b>AIR ASSIST BAGS</b>				
TDAA-104	1	Bellows bag kit		Suits 40mm Lift

### REPLACEMENT BUSHINGS

QUANTITY PER SHOCK				
TOY-1081	1	Replacement Strut Top		Available As Complete Unit Only
ADJ00300/40	1	Suits Bottom Front Eye		Eyering Bonded Bushing
404702	2	Suits Top & Bottom Rear Eyering		Eyering Bushing

Vehicle fitment sheet must be completed when suspension fitted. Failure to do so may affect warranty.  
Fitment sheet can be found on page 200 of this catalogue

**Note: Kit price reference does not include handbrake relocation kit. Please add to kit for MY17 on vehicles**

# HOLDEN

## COLORADO

11/11 On  
RG, MMU142, GM1700

### COMPLETE KIT PRICE REFERENCE

SHOCK CHOICE	SPRING CHOICE	RRP inc GST	CONTENTS
<b>Foam Cell Struts Require Assembly</b> <b>Includes</b> 2x Front Struts 2x Rear Shocks 2x Front Coils 2x Leaf Springs 1x Urethane Kit 2x U-Bolt Kits	<b>FS214C</b> (Foam Front Gas Rear)		
	<b>FS214C</b> (Foam Cell All)  <b>FS214L</b> <b>CONSTANT 300KG</b>  <b>FS214LL</b> <b>CONSTANT 500KG</b>		
<b>Foam Cell Complete Assembly Struts</b> <b>Includes</b> 2x Front Strut Assy 2x Rear Shocks 2x Leaf Springs 1x Urethane Kit 2x U-Bolt Kits	<b>FS214C</b> (Foam Front Gas Rear)		
	<b>FS214C</b> (Foam Cell All)  <b>FS214L</b> <b>CONSTANT 300KG</b>  <b>FS214LL</b> <b>CONSTANT 500KG</b>		
<b>40mm Adjustable Struts Require Assembly</b> <b>Includes</b> 2x Front Struts 2x Rear Shocks 2x Front Coils 2x Leaf Springs 1x Urethane Kit 2x U-Bolt Kits	<b>FS214C</b> 0-300KG		
	<b>FS214L</b> <b>CONSTANT 300KG</b>  <b>FS214LL</b> <b>CONSTANT 500KG</b>		
<b>40mm Adjustable Complete Assembly Struts</b> <b>Includes</b> 2x Front Strut Assy 2x Rear Shocks 2x Leaf Springs 1x Urethane Kit 2x U-Bolt Kits	<b>FS214C</b> 0-300KG		
	<b>FS214L</b> <b>CONSTANT 300KG</b>  <b>FS214LL</b> <b>CONSTANT 500KG</b>		

Freight should be added where required. When determining spring choice, include only permanent accessories & weights. Towing requirements are not included in constant load determination

# HOLDEN

## COLORADO 7/TRAILBLAZER

11/11 On  
ALL MODELS



### FRONT SUSPENSION

**ESTIMATED LIFT: 40mm**

PART NO.	QTY	DESCRIPTION	RRP inc GST	NOTES
<b>SHOCK ABSORBERS</b>				
FC404200	2	41mm Foam Cell Strut		
BM404200	2	40mm Adjustable Strut		9 Stage Adjustable
<b>COIL SPRINGS</b>				
TDC270	2	40mm Lift Spring		Petrol/Diesel/Bar
TDC974	2	40mm Lift Spring		Petrol/Diesel/Bar/Winch
<b>COMPLETE STRUT ASSEMBLY</b>				
HOL-001	2	BM404200/TDC270		Petrol/Diesel/Bar
HOL-002	2	BM404200/TDC974		Petrol/Diesel/Bar/Winch
HOL-003	2	FC404200/TDC270		Petrol/Diesel/Bar
HOL-004	2	FC404200/TDC974		Petrol/Diesel/Bar/Winch
<b>REPLACEMENT STRUT TOP</b>				
TOY-1081	2	Strut Top		Replacement Strut Top

### REAR SUSPENSION

<b>SHOCK ABSORBERS</b>				
BD1125T	2	35mm Nitrogen Gas Shock		Suits Up to 40mm Lift
FC41125	2	41mm Foam Cell Shock		Suits Up to 40mm Lift
BM401125	2	40mm 9 Stage Adjustable		Suits Up to 40mm Lift
<b>COIL SPRINGS</b>				
TDC271	2	0-300kg Load		40mm Lift
TDC271H	2	<b>CONSTANT</b> 300Kg Load		40mm Lift
<b>AIR ASSIST BAGS</b>				
TDAA-005	1	Coil insert bag kit		Suits 40mm Lift

### REPLACEMENT BUSHINGS

QUANTITY PER SHOCK				
TOY-1081	1	Replacement Strut Top		Available As Complete Unit Only
ADJ00300/40	1	Suits Bottom Front Eye		Eyering Bonded Bushing
TW040/14	1	Suits Rear Bottom Eye		Eyering Bush
TW959	2	Suits Rear Top Pin		Pin Style Bushing

### COMPLETE KIT PRICE REFERENCE

SHOCK CHOICE	SPRING CHOICE	RRP inc GST	CONTENTS
41mm Foam Cell Note: To use gas rear	Any Any (Complete Assy)		
9 Stage Adjustable	Any Any (Complete Assy)		

**Front Struts can be purchased Assembled or as Separate Components**

Vehicle fitment sheet must be completed when suspension fitted. Failure to do so may affect warranty.

Fitment sheet can be found on page 200 of this catalogue



# HYUNDAI TERRACAN 12/01 On HP

## FRONT SUSPENSION

**ESTIMATED LIFT: 45 mm**

PART NO.	QTY	DESCRIPTION	RRP inc GST	NOTES
<b>SHOCK ABSORBERS</b>				
FC42059B	2	41mm Foam Cell Shock		Suits up to 45mm Lift
<b>TORSION BARS</b>				
4WTB-1725	1	Replacement Torsion Bars		27.5mm/1275mm
<b>Adjust Torsion bars after fitting shocks - Ensure a minimum of 60mm Droop is Maintained</b>				

## REAR SUSPENSION

<b>SHOCK ABSORBERS</b>				
FC41120B	2	41mm Foam Cell Shock		Suits OE Height
BM401120	2	40mm 9 Stage Adjustable		
FC41121B	2	41mm Foam Cell Shock		Suits 45mm Lift
BM401121	2	40mm 9 Stage Adjustable		
<b>COIL SPRINGS</b>				
TDC680	2	0-300kg Load		45mm Lift
TDC632SL	2	<b>CONSTANT</b> 300Kg Load		45mm Lift

## REPLACEMENT BUSHINGS

<b>QUANTITY PER SHOCK</b>				
402267	2	Suits Top Front Pin		Pin Style Bushing
402267	2	Suits Top Rear Pin		Pin Style Bushing
ADJ00191	1	Suits Bottom Rear Eye		Eyering Bushing
412772	1	Suits Bottom Front Eye		Eyering Bushing

## COMPLETE KIT PRICE REFERENCE

SHOCK CHOICE	SPRING CHOICE	RRP inc GST	CONTENTS
41mm Foam Cell	0-300KG Constant 300kg		
Foam Cell Front Adjustable Rear	0-300KG Constant 300kg		
<b>Includes</b> 2 x Coil Springs      4 x Shocks			

Freight should be added where required. When determining spring choice, include only permanent accessories & weights. Towing requirements are not included in constant load determination

# ISUZU

## D-MAX

04/08-12

MY09-MY11



### FRONT SUSPENSION

**ESTIMATED LIFT: 45 mm**

PART NO.	QTY	DESCRIPTION	RRP inc GST	NOTES
<b>SHOCK ABSORBERS</b>				
FC42019B	2	41mm Foam Cell Shock		Suits up to 45mm Lift
<b>TORSION BARS</b>				
4WTB-1559	1	Replacement Torsion Bars		30mm/1145mm
<b>Adjust Torsion bars after fitting shocks - Ensure a minimum of 60mm Droop is Maintained</b>				

### REAR SUSPENSION

<b>SHOCK ABSORBERS</b>				
BD1382T	2	35mm Nitrogen Gas Shock		Suits OE Height
FC41382	2	41mm Foam Cell Shock		
BM401382	2	40mm 9 Stage Adjustable		
BD1388T	2	35mm Nitrogen Gas Shock		Suits 45mm Lift
FC41388	2	41mm Foam Cell Shock		
BM401388	2	40mm 9 Stage Adjustable		
<b>LEAF SPRINGS</b>				
FS213	2	0-300kg Load		45mm Lift
FS213H	2	<b>CONSTANT</b> 300Kg Load		45mm Lift
<b>COMPONENTS</b>				
TDUK-065	1	Urethane Shackle Bushing Kit		
TDUB-039	2	U-Bolt Kit		
TDGS-386	1	Greasable Shackle Kit		
TDGP-668	1	Greasable Pin Kit		
<b>AIR ASSIST BAGS</b>				
TDAA-103	1	Bellows bag kit		Suits 45mm Lift



### REPLACEMENT BUSHINGS

QUANTITY PER SHOCK				
TW959	2	Suits Top Front Pin		Pin Style Bushing
412772	1	Suits Bottom Front Eye		Eyering Bushing
404702	2	Suits Top & Bottom Rear Eye		Eyering Bushing

Vehicle fitment sheet must be completed when suspension fitted. Failure to do so may affect warranty.  
Fitment sheet can be found on page 200 of this catalogue



### COMPLETE KIT PRICE REFERENCE

SHOCK CHOICE	SPRING CHOICE	RRP inc GST	CONTENTS
<p><b>Foam Cell Front Nitro Gas Rear</b></p> <p><u>Includes</u> 2x Front Shocks 2x Rear Shocks 2x Leaf Springs 1x Urethane Kit 2x U-Bolt Kits</p>	<p><b>FS213 0-300KG Spring</b></p>		
<p><b>41mm Foam Cell</b></p> <p><u>Includes</u> 2x Front Shocks 2x Rear Shocks 2x Leaf Springs 1x Urethane Kit 2x U-Bolt Kits</p>	<p><b>FS213 0-300KG Spring</b></p> <p><b>FS213H CONSTANT 300KG Spring</b></p>		
<p><b>Foam Cell Front Adjustable Rear</b></p> <p><u>Includes</u> 2x Front Shocks 2x Rear Shocks 2x Leaf Springs 1x Urethane Kit 2x U-Bolt Kits</p>	<p><b>FS213 0-300KG Spring</b></p> <p><b>FS213H CONSTANT 300KG Spring</b></p>		

Freight should be added where required. When determining spring choice, include only permanent accessories & weights. Towing requirements are not included in constant load determination

# ISUZU

## D-MAX

05/12 On

TFS85, V-CROSS, MY12



### FRONT SUSPENSION

**ESTIMATED LIFT: 40mm**

PART NO.	QTY	DESCRIPTION	RRP inc GST	NOTES
<b>SHOCK ABSORBERS</b>				
FC404200	2	40mm Foam Cell Strut		
BM404200	2	40mm Adjustable Strut		9 Stage Adjustable
<b>COIL SPRINGS</b>				
TDC270	2	40mm Lift Spring		Petrol/Diesel/Up to Alloy Bar
TDC974	2	40mm Lift Spring		Petrol/Diesel/Bar
TDC974H	2	40mm Lift Spring		Petrol/Diesel/Bar/Winch
<b>COMPLETE STRUT ASSEMBLY</b>				
HOL-001	2	BM404200/TDC270		Petrol/Diesel/Up to Alloy Bar
HOL-002	2	BM404200/TDC974		Petrol/Diesel/Steel Bar
HOL-005	2	BM404200/TDC974H		Petrol/Diesel/Bar/Winch
HOL-003	2	FC404200/TDC270		Petrol/Diesel/Up to Alloy Bar
HOL-004	2	FC404200/TDC974		Petrol/Diesel/Steel Bar
HOL-006	2	FC404200/TDC974H		Petrol/Diesel/Bar/Winch
<b>REPLACEMENT STRUT TOP</b>				
TOY-1081	2	Strut Top		Replacement Strut Top

### REAR SUSPENSION

<b>SHOCK ABSORBERS</b>				
BD1382T	2	35mm Nitrogen Gas Shock		Suits Up to 40mm Lift
FC41382	2	41mm Foam Cell Shock		Suits Up to 40mm Lift
BM401382	2	40mm 9 Stage Adjustable		Suits Up to 40mm Lift
<b>LEAF SPRINGS</b>				
FS214C	2	0-300kg Load		40mm Lift
FS214L	2	<b>CONSTANT</b> 300Kg Load		40mm Lift
FS214LL	2	<b>CONSTANT</b> 500Kg Load		40mm Lift
<b>COMPONENTS</b>				
TDUK-071	1	Urethane Shackle Bushing Kit		
TDUB-016	2	U-Bolt Kit		
TDGS-391	1	Greasable Shackle Kit		
TDGP-668	1	Greasable Pin Kit		
TDSK-021	1	Handbrake Relocation kit		Req'd for <b>up to</b> MY15.5 vehicles
<b>Handbrake Relocation kit is required for all vehicles to MY15.5 (04/16 release) Not req'd for 04/16 onward.</b>				
<b>AIR ASSIST BAGS</b>				
TDAA-104	1	Bellows bag kit		Suits 40mm Lift

### REPLACEMENT BUSHINGS

QUANTITY PER SHOCK				
TOY-1081	1	Replacement Strut Top		Available As Complete Unit Only
ADJ00300/40	1	Suits Bottom Front Eye		Eyering Bonded Bushing
404702	2	Suits Top & Bottom Rear Eyering		Eyering Bushing

Vehicle fitment sheet must be completed when suspension fitted. Failure to do so may affect warranty.

Fitment sheet can be found on page 200 of this catalogue





**Note: Kit price reference includes handbrake relocation kit.  
Please remove from kit for MY15.5 on vehicles**

# ISUZU

## D-MAX 05/12 On

### TFS85, V-CROSS, MY12

## COMPLETE KIT PRICE REFERENCE

SHOCK CHOICE	SPRING CHOICE	RRP inc GST	CONTENTS
<b>Foam Cell Struts Require Assembly</b> <b>Includes</b> 2x Front Struts 2x Rear Shocks 2x Front Coils 2x Leaf Springs 1x Urethane Kit 2x U-Bolt Kits 1x Handbrake Bkt Kit	<b>FS214C</b> (Foam Front Gas Rear)		
	<b>FS214C</b> (Foam Cell All)  <b>FS214L</b> <b>CONSTANT 300KG</b>  <b>FS214LL</b> <b>CONSTANT 500KG</b>		
<b>Foam Cell Complete Assembly Struts</b> <b>Includes</b> 2x Front Strut Assy 2x Rear Shocks 2x Leaf Springs 1x Urethane Kit 2x U-Bolt Kits 1x Handbrake Bkt Kit	<b>FS214C</b> (Foam Front Gas Rear)		
	<b>FS214C</b> (Foam Cell All)  <b>FS214L</b> <b>CONSTANT 300KG</b>  <b>FS214LL</b> <b>CONSTANT 500KG</b>		
<b>40mm Adjustable Struts Require Assembly</b> <b>Includes</b> 2x Front Struts 2x Rear Shocks 2x Front Coils 2x Leaf Springs 1x Urethane Kit 2x U-Bolt Kits 1x Handbrake Bkt Kit	<b>FS214C</b> 0-300KG		
	<b>FS214L</b> <b>CONSTANT 300KG</b>  <b>FS214LL</b> <b>CONSTANT 500KG</b>		
<b>40mm Adjustable Complete Assembly Struts</b> <b>Includes</b> 2x Front Struts 2x Rear Shocks 2x Leaf Springs 1x Urethane Kit 2x U-Bolt Kits 1x Handbrake Bkt Kit	<b>FS214C</b> 0-300KG		
	<b>FS214L</b> <b>CONSTANT 300KG</b>  <b>FS214LL</b> <b>CONSTANT 500KG</b>		

Freight should be added where required. When determining spring choice, include only permanent accessories & weights. Towing requirements are not included in constant load determination

# ISUZU

**MU-X**  
8/14 On  
MY13 On



## FRONT SUSPENSION

**ESTIMATED LIFT: 40mm**

PART NO.	QTY	DESCRIPTION	RRP inc GST	NOTES
<b>SHOCK ABSORBERS</b>				
FC404200	2	40mm Foam Cell Strut		
BM404200	2	40mm Adjustable Strut		9 Stage Adjustable
<b>COIL SPRINGS</b>				
TDC270	2	40mm Lift Spring		Petrol/Diesel/Up to Alloy Bar
TDC974	2	40mm Lift Spring		Petrol/Diesel/Bar
TDC974H	2	40mm Lift Spring		Petrol/Diesel/Bar/Winch
<b>COMPLETE STRUT ASSEMBLY</b>				
HOL-001	2	BM404200/TDC270		Petrol/Diesel/Up to Alloy Bar
HOL-002	2	BM404200/TDC974		Petrol/Diesel/Steel Bar
HOL-005	2	BM404200/TDC974H		Petrol/Diesel/Bar/Winch
HOL-003	2	FC404200/TDC270		Petrol/Diesel/Up to Alloy Bar
HOL-004	2	FC404200/TDC974		Petrol/Diesel/Steel Bar
HOL-006	2	FC404200/TDC974H		Petrol/Diesel/Bar/Winch
<b>REPLACEMENT STRUT TOP</b>				
TOY-1081	2	Strut Top		Replacement Strut Top





## REAR SUSPENSION

<b>SHOCK ABSORBERS</b>				
BD1125T	2	35mm Nitrogen Gas Shock		Suits Up to 40mm Lift
FC41125	2	41mm Foam Cell Shock		Suits Up to 40mm Lift
BM401125	2	40mm 9 Stage Adjustable		Suits Up to 40mm Lift
<b>COIL SPRINGS</b>				
TDC272SL	2	0-300kg Load		O.E Height
TDC272	2	0-300kg Load		40mm Lift
TDC272H	2	<b>CONSTANT</b> 300Kg Load		40mm Lift
<b>AIR ASSIST BAGS</b>				
TDAA-005	1	Coil insert bag kit		Suits 40mm Lift

## REPLACEMENT BUSHINGS

QUANTITY PER SHOCK				
TOY-1081	1	Replacement Strut Top		Available As Complete Unit Only
ADJ00300/40	1	Suits Bottom Front Eye		Eyering Bonded Bushing
TW040/14	1	Suits Rear Bottom Eye		Eyering Bush
TW959	2	Suits Rear Top Pin		Pin Style Bushing

Vehicle fitment sheet must be completed when suspension fitted. Failure to do so may affect warranty.  
Fitment sheet can be found on page 200 of this catalogue

SHOCK CHOICE	SPRING CHOICE	RRP inc GST	CONTENTS
<b>Foam Cell Struts Require Assembly</b> <u>Includes</u> 4 x Coil Springs 4 x Shocks	ANY (Foam Front Gas Rear)		
	ANY (Foam Cell All)		
<b>Foam Cell Complete Assembly Struts</b> <u>Includes</u> 2 x Front Strut Assy 2 x Coil Springs 2 x Rear Shocks	ANY (Foam Front Gas Rear)		
	ANY (Foam Cell All)		
<b>40mm Adjustable Struts Require Assembly</b> <u>Includes</u> 4 x Coil Springs 4 x Shocks	ANY		
<b>40mm Adjustable Complete Assembly Struts</b> <u>Includes</u> 2 x Front Strut Assy 2 x Coil Springs 2 x Rear Shocks	ANY		

Freight should be added where required. When determining spring choice, include only permanent accessories & weights. Towing requirements are not included in constant load determination

# JEEP CHEROKEE

4/94-01  
XJ Limited, Sport

**Note: Transmission spacer  
fitting instructions available  
at [toughdog.com.au](http://toughdog.com.au)**



## FRONT SUSPENSION

**ESTIMATED LIFT: 35 mm**

PART NO.	QTY	DESCRIPTION	RRP inc GST	NOTES
<b>SHOCK ABSORBERS</b>				
FC41063	2	41mm Foam Cell Shock		Suits OE Height
BM401063	2	40mm 9 Stage Adjustable		
FC41068	2	41mm Foam Cell Shock		Suits 35mm Lift
BM401068	2	40mm 9 Stage Adjustable		
<b>COIL SPRINGS</b>				
TDC333	2	35mm Lift		Petrol/Diesel/Bar
TDC352	2	35mm Lift		Petrol/Diesel/Bar/Winch
<b>STEERING DAMPERS</b>				
SS5922-P/S	1	Return to Centre Damper		Power Steering
SV5922	1	9 Stage Adjustable Damper		

## REAR SUSPENSION

<b>SHOCK ABSORBERS</b>				
FC41241	2	41mm Foam Cell Shock		Suits OE Height
BM401241	2	40mm 9 Stage Adjustable		
FC41249	2	41mm Foam Cell Shock		Suits 35mm Lift
BM401249	2	40mm 9 Stage Adjustable		
<b>LEAF SPRINGS</b>				
FS025H	2	0-300kg Load		35mm Lift
<b>COMPONENTS</b>				
TDUK-027	1	Urethane Shackle Bushes		
TDUB-027	2	U-bolt Kit		
TDSP-002	1	Transmission Spacer		

## REPLACEMENT BUSHINGS

QUANTITY PER SHOCK				
TW959	2	Suits Top Front Pin		Pin Style Bushing
404702	1	Suits Bottom Rear Eye		Eyering Bushing

**Bar Pin Style Bushings are not User Servicable - Contact 4Way Suspension for Replacement Service**

## COMPLETE KIT PRICE REFERENCE

SHOCK CHOICE	SPRING CHOICE	RRP inc GST	CONTENTS
41mm Foam Cell	ANY		
9 Stage Adjustable	ANY		
<b>Includes</b> 2 x Coil Springs    4 x Shocks 2 x Leaf Springs    2 x U-Bolts 1 x Urethane kit    1 x Transmission Spacer			

Vehicle fitment sheet must be completed when suspension fitted. Failure to do so may affect warranty.  
Fitment sheet can be found on page 200 of this catalogue



# JEEP

## GRAND CHEROKEE

ZG - 4/96-99  
WG, WJ - 6/99-05

### FRONT SUSPENSION

**ESTIMATED LIFT: 30mm**

PART NO.	QTY	DESCRIPTION	RRP inc GST	NOTES
<b>SHOCK ABSORBERS</b>				
FC41068	2	41mm Foam Cell Shock		
BM401068	2	40mm Adjustable Shock		9 Stage Adjustable
<b>COIL SPRINGS</b>				
TDC358	2	40mm Lift Spring		30mm Lift-ZG 4/96-99 ONLY
TDC360	2	40mm Lift Spring		30mm Lift-WG, WJ 6/99-05 ONLY
<b>STEERING DAMPERS</b>				
SS5922-P/S	1	Return to Centre Damper		ZG 4/96-99 ONLY
SV5922	1	9 Stage Adjustable Damper		
SS5924-P/S	1	Return to Centre Damper		WG, WJ 6/99-05 ONLY
SV5924	1	9 Stage Adjustable Damper		

### REAR SUSPENSION

<b>SHOCK ABSORBERS</b>				
FC41444	2	41mm Foam Cell Shock		ZG 4/96-99 ONLY
BM401444	2	40mm 9 Stage Adjustable		Suits up to 30mm Lift
FC41190	2	41mm Foam Cell Shock		WG, WJ 6/99-05 ONLY
BM401190	2	40mm 9 Stage Adjustable		Suits up to 30mm Lift
<b>COIL SPRINGS</b>				
TDC359	2	0-300kg Load		30mm Lift-ZG 4/96-99 ONLY
TDC361	2	0-300kg Load		30mm Lift-WG, WJ 6/99-05 ONLY

### REPLACEMENT BUSHINGS

QUANTITY PER SHOCK				
TW959	2	Suits Top Front Pin		Pin Style Bushing
404702	1	Suits Top Rear Eye (ZG)		Eyering Bushing
<b>Bar Pin Style Bushings are not User Servicable - Contact 4Way Suspension for Replacement Service</b>				

### COMPLETE KIT PRICE REFERENCE

SHOCK CHOICE	SPRING CHOICE	RRP inc GST	CONTENTS
41mm Foam Cell	Any		
9 Stage Adjustable	Any		
<b>Includes</b>			
4 x Coil Springs      4 x Shocks			

Freight should be added where required. When determining spring choice, include only permanent accessories & weights. Towing requirements are not included in constant load determination

# JEEP WRANGLER 10/96-07 TJ

**Note: Transmission spacer fitting instructions available at [toughdog.com.au](http://toughdog.com.au)**



## FRONT SUSPENSION

**ESTIMATED LIFT: 45mm**

PART NO.	QTY	DESCRIPTION	RRP inc GST	NOTES
<b>SHOCK ABSORBERS</b>				
BD1063T	2	35mm Nitro Gas Shocks		Suits OE Height
BM401063	2	40mm Adjustable Shock		
BD1068T	2	35mm Nitro Gas Shocks		Suits 45mm Lift
BM401068	2	40mm Adjustable Shock		
<b>COIL SPRINGS</b>				
TDC354	2	40mm Lift Spring		Suits up to Bullbar (45mm Lift)
<b>STEERING DAMPERS</b>				
SS5922-P/S	1	Return to Centre Damper		Power Steering
SV5922	1	9 Stage Adjustable Damper		
<b>TRANSMISSION SPACERS</b>				
TDSP-001	1	Transmission Spacer		Man & Auto - 10/96-03 ONLY
TDSP-005	1	Transmission Spacer		Auto - 03-07 ONLY
TDSP-006	1	Transmission Spacer		Manual - 03-07 ONLY

## REAR SUSPENSION

<b>SHOCK ABSORBERS</b>				
BD1443T	2	35mm Nitro Gas Shocks		Suits OE Height
BM401443	2	40mm Adjustable Shock		
BD1461T	2	35mm Nitro Gas Shocks		Suits 45mm Lift
BM401461	2	40mm Adjustable Shock		
<b>COIL SPRINGS</b>				
TDC355	2	0-300kg Load		45mm Lift

## REPLACEMENT BUSHINGS

QUANTITY PER SHOCK				
TW959	2	Suits Top Front Pin		Pin Style Bushing
<b>Bar Pin Style Bushings are not User Servicable - Contact 4Way Suspension for Replacement Service</b>				

## COMPLETE KIT PRICE REFERENCE

SHOCK & SPRING	SPACER	RRP inc GST	CONTENTS
35mm Nitro Gas Any Spring	TDSP-001		
	TDSP-005		
	TDSP-006		
9 Stage Adjustable Any Spring	TDSP-001		
	TDSP-005		
	TDSP-006		
<b>Includes</b> 4 x Coil Springs    4 x Shocks 1 x Transmission Spacer			

Vehicle fitment sheet must be completed when suspension fitted. Failure to do so may affect warranty.  
Fitment sheet can be found on page 200 of this catalogue





# JEEP WRANGLER

3/07 On  
JK

## FRONT SUSPENSION

**ESTIMATED LIFT: 40 mm**

PART NO.	QTY	DESCRIPTION	RRP inc GST	NOTES
<b>SHOCK ABSORBERS</b>				
BM401069	2	40mm Adjustable Shock		Suits up to 40mm Lift
<b>COIL SPRINGS</b>				
TDC331	2	40mm Lift Spring		Petrol SWB - Up to bullbar
TDC332	2	40mm Lift Spring		Petrol SWB - Bullbar & Winch
TDC337	2	40mm Lift Spring		Petrol LWB - Up To Bullbar
TDC338	2	40mm Lift Spring		Petrol LWB - Bullbar & Winch
TDC332	2	40mm Lift Spring		Diesel SWB - Up to Bullbar
TDC338	2	40mm Lift Spring		Diesel SWB - Bullbar & Winch
TDC338	2	40mm Lift Spring		Diesel LWB - Up to Bullbar
TDC342	2	40mm Lift Spring		Diesel LWB - Bullbar & Winch
<b>STEERING DAMPERS</b>				
SV5926	1	9 Stage Adjustable Damper		instructions at toughdog.com.au
<b>PANHARD RODS</b>				
TDPR-017	1	Adjustable Panhard Rod		

## REAR SUSPENSION

<b>SHOCK ABSORBERS</b>				
BM401463	2	40mm 9 Stage Adjustable Shock		Suits 40mm Lift
<b>COIL SPRINGS</b>				
TDC340	2	0-300kg Load		40mm Lift (suits SWB only)
TDC339	2	<b>CONSTANT</b> 300Kg Load SWB		40mm Lift (also 0-300kg for LWB)
TDC341	2	<b>CONSTANT</b> 300Kg Load LWB		40mm Lift

## REPLACEMENT BUSHINGS

QUANTITY PER SHOCK				
TW959	2	Suits Top Front Pin		Pin Style Bushing
4W-SPF420-04	1	Suits Bottom Front Eying		Eying Bushing

**Bar Pin Style Bushings (rear) are not User Servicable - Contact 4Way Suspension for Replacement Service**

## COMPLETE KIT PRICE REFERENCE

SHOCK CHOICE	SPRING CHOICE	RRP inc GST	CONTENTS
9 Stage Adjustable	Any		
<p align="center"><b>Includes</b> 4 x Coil Springs      4 x Shocks</p>			

Freight should be added where required. When determining spring choice, include only permanent accessories & weights. Towing requirements are not included in constant load determination

# LAND ROVER

80, 88 SWB, 109 LWB

53-83

SERIES I, II, IIA & III



## FRONT SUSPENSION

**ESTIMATED LIFT: No Springs Avail.**

PART NO.	QTY	DESCRIPTION	RRP inc GST	NOTES
<b>SHOCK ABSORBERS</b>				
BD2000T	2	35mm Nitro Gas Shocks		Suits up to 50mm Lift
FC42000	2	41mm Foam Cell Shocks		Suits up to 50mm Lift
<b>STEERING DAMPERS</b>				
EXT5000	1	H/Duty Steering Damper		Suits SI, II, IIA & III
SS5000-M/S	1	Return to Centre Damper		Suits Series I ONLY
SV5000	1	9 Stage Adjustable Damper		Suits SII, IIA, III ONLY

## REAR SUSPENSION

<b>SHOCK ABSORBERS</b>				
BD3005T	2	35mm Nitro Gas Shocks		Suits '53-83 SI, II, IIA, III SWB
FC43005	2	41mm Foam Cell Shock		And '53-58 SI LWB
BD1399T	2	35mm Nitro Gas Shocks		Suits '58-83 SII, III LWB
FC41399	2	41mm Foam Cell Shock		

## REPLACEMENT BUSHINGS

QUANTITY PER SHOCK				
4W-SPF390	2	Suits Top & Bottom Front Eye		Eye Ring Bushing
4W-SPF390	2	Suits Top & Bottom Rear Eying		Eying Bushing for #3005 shocks
4W-SPF390	1	Suits Top Eye Mount		Eying Busing for #1399 shocks
TW959	2	Suits Bottom Rear Pin Mount		Pin Bushing for #1399 shocks

Vehicle fitment sheet must be completed when suspension fitted. Failure to do so may affect warranty.  
Fitment sheet can be found on page 200 of this catalogue



# LAND ROVER

## DEFENDER

11/84-91  
110 COUNTY ONLY

### FRONT SUSPENSION

**ESTIMATED LIFT: 30 mm**

PART NO.	QTY	DESCRIPTION	RRP inc GST	NOTES
<b>SHOCK ABSORBERS</b>				
FC41049	2	41mm Foam Cell Shocks		Suits up to 30mm Lift
BM401049	2	40mm Adjustable Shock		Suits up to 30mm Lift
BMX1049/2	2	45mm Adjustable Shock		Suits up to 30mm Lift
TDR1049B	2	53mm 'Ralph' Shock		Suits up to 30mm Lift
<b>COIL SPRINGS</b>				
TDC511	2	30mm Lift Spring		Suits Petrol with Bar
TDC513	2	30mm Lift Spring		Suits Diesel with Bar
TDC508H	2	30mm Lift Spring		Suits All with bar & Winch
<b>STEERING DAMPERS</b>				
EXT5009	1	H/Duty Steering Damper		
SS5009-P/S	1	Return to Centre Damper		
SV5009	1	9 Stage Adjustable Damper		
<b>PANHARD RODS</b>				
TDPR-002	1	Panhard Rod (14mm Sleeve)		Up to Chassis #2A626645
TDPR-018	1	Panhard Rod (16mm Sleeve)		Up to Chassis #2A626646

### REAR SUSPENSION

<b>SHOCK ABSORBERS</b>				
FC41397	2	41mm Foam Cell Shocks		Suits up to 30mm Lift
BM401397	2	40mm Adjustable Shock		<b>Fit this part number if the lower rubber bushes are conical in shape &amp; fit into a metal housing.</b>
BMX1397/2	2	45mm Adjustable Shock		
TDR1397B	2	53mm 'Ralph' Shock		
FC41398	2	41mm Foam Cell Shocks		
BM401398	2	40mm Adjustable Shock		<b>Fit this part number if the lower rubber bushes are flat &amp; approx. 45mm in diameter</b>
BMX1398/2	2	45mm Adjustable Shock		
TDR1398	2	53mm 'Ralph' Shock		
TDC512	2	0-300kg Load		
TDC512HH	2	<b>CONSTANT</b> 300Kg Load		30mm Lift

### REPLACEMENT BUSHINGS

QUANTITY PER SHOCK				
TW957	4	Suits Top & Bottom Front Pin		
TW967	2	Suits Bottom Rear Pin		Pin Style Bushing #1397 Shocks
415024	1	Suits Top Rear Eye		Eyering Bushing #1397 Shocks
ADJ00191	1	Suits Top Rear Eye		Eyering Bushing #1398 Shocks
TW957	2	Suits Bottom Rear Pin		Pin Style Bushing #1398 Shocks

### COMPLETE KIT PRICE REFERENCE

**FOR COMPLETE KIT PRICING REFERENCE PLEASE USE  
LAND ROVER DEFENDER 90-130 SERIES ON NEXT PAGE**

*Freight should be added where required. When determining spring choice, include only permanent accessories & weights. Towing requirements are not included in constant load determination*

# LAND ROVER

## DEFENDER

92 On

90, 110, 130 Series



### FRONT SUSPENSION

**ESTIMATED LIFT: 30mm**

PART NO.	QTY	DESCRIPTION	RRP inc GST	NOTES
<b>SHOCK ABSORBERS</b>				
FC41049	2	41mm Foam Cell Shocks		Suits up to 30mm Lift
BM401049	2	40mm Adjustable Shock		Suits up to 30mm Lift
BMX1049/2	2	45mm Adjustable Shock		Suits up to 30mm Lift
TDR1049B	2	53mm 'Ralph' Shock		Suits up to 30mm Lift
<b>COIL SPRINGS</b>				
TDC505	2	30mm Lift Spring		Suits 90 S Petrol with Bar
TDC535	2	30mm Lift Spring		Suits 90 S Petrol Bar/Winch Or Dies with Bar
TDC504	2	30mm Lift Spring		Suits 90 Series with Bar & Winch
TDC520	2	30mm Lift Spring		Suits 110, 130 with Bar
TDC514	2	30mm Lift Spring		Suits 110, 130 with Bar & Winch
<b>STEERING DAMPERS</b>				
EXT5009	1	H/Duty Steering Damper		
SS5009-P/S	1	Return to Centre Damper		
SV5009	1	9 Stage Adjustable Damper		
<b>PANHARD RODS</b>				
TDPR-002	1	Panhard Rod (14mm Sleeve)		Up to Chassis #2A626645
TDPR-018	1	Panhard Rod (16mm Sleeve)		Up to Chassis #2A626646

### REAR SUSPENSION

<b>SHOCK ABSORBERS</b>				
FC41397	2	41mm Foam Cell Shocks		Suits up to 30mm Lift
BM401397	2	40mm Adjustable Shock		<b>Fit this part number if the lower rubber bushes are conical in shape &amp; fit into a metal housing.</b>
BMX1397/2	2	45mm Adjustable Shock		
TDR1397B	2	53mm 'Ralph' Shock		
FC41398	2	41mm Foam Cell Shocks		
BM401398	2	40mm Adjustable Shock		<b>Fit this part number if the lower rubber bushes are flat &amp; approx. 45mm in diameter</b>
BMX1398/2	2	45mm Adjustable Shock		
TDR1398	2	53mm 'Ralph' Shock		
<b>COIL SPRINGS</b>				
TDC518	2	0-300kg Load		30mm Lift - Suit 90s SWB
TDC518H	2	<b>CONSTANT</b> 300Kg Load		30mm Lift - Suit 90s SWB
TDC504	2	<b>CONSTANT</b> 500Kg Load		30mm Lift - Suit 90s SWB
TDC536	2	0-300kg Load		30mm Lift - Suit 110s
TDC523	2	0-500kg Load		30mm Lift - Suit 130s LWB
TDC522H	2	<b>CONSTANT</b> 500Kg Load		30mm Lift - Suit 130s LWB

### REPLACEMENT BUSHINGS

**FOR REPLACEMENT BUSHING PART NUMBERS, PLEASE SEE LAND ROVER DEFENDER 110 COUNTY ON PAGE 58**

Vehicle fitment sheet must be completed when suspension fitted. Failure to do so may affect warranty.  
Fitment sheet can be found on page 200 of this catalogue





# LAND ROVER

## DEFENDER

92 On

90, 110, 130 Series

### COMPLETE KIT PRICE REFERENCE

SHOCK CHOICE	SPRING CHOICE	RRP inc GST	CONTENTS
<b>41mm Foam Cell</b>  <u>Includes</u> 2x Front shocks 2x Rear Shocks 2x Front Coils 2x Rear Coils	\$ 135 Coil (Front & Rear)  \$ 165 Rear Coil  \$ 185 Rear Coil  \$ 216 Rear Coil		
<b>40mm Adjustable</b>  <u>Includes</u> 2x Front shocks 2x Rear Shocks 2x Front Coils 2x Rear Coils	\$ 135 Coil (Front & Rear)  \$ 165 Rear Coil  \$ 185 Rear Coil  \$ 216 Rear Coil		
<b>45mm Big Bore Adjustable</b>  <u>Includes</u> 2x Front shocks 2x Rear Shocks 2x Front Coils 2x Rear Coils	\$ 135 Coil (Front & Rear)  \$ 165 Rear Coil  \$ 185 Rear Coil  \$ 216 Rear Coil		
<b>53mm 'Ralph' Big Bore</b>  <u>Includes</u> 2x Front shocks 2x Rear Shocks 2x Front Coils 2x Rear Coils	\$ 135 Coil (Front & Rear)  \$ 165 Rear Coil  \$ 185 Rear Coil  \$ 216 Rear Coil		

Freight should be added where required. When determining spring choice, include only permanent accessories & weights. Towing requirements are not included in constant load determination

# LAND ROVER

## DISCOVERY

4/91-99

SERIES I



### FRONT SUSPENSION

**ESTIMATED LIFT: 30mm**

PART NO.	QTY	DESCRIPTION	RRP inc GST	NOTES
<b>SHOCK ABSORBERS</b>				
FC41049	2	41mm Foam Cell Shocks		Suits up to 30mm Lift
BM401049	2	40mm Adjustable Shock		Suits up to 30mm Lift
BMX1049/2	2	45mm Adjustable Shock		Suits up to 30mm Lift
TDR1049B	2	53mm 'Ralph' Shock		Suits up to 30mm Lift
<b>COIL SPRINGS</b>				
TDC505	2	30mm Lift Spring		Suits All with Bar
TDC504	2	30mm Lift Spring		Suits All with Bar & Winch
<b>STEERING DAMPERS</b>				
EXT5000	1	H/Duty Steering Damper		
SS5000-P/S	1	Return to Centre Damper		Power Steering
SV5000	1	9 Stage Adjustable Damper		
<b>PANHARD RODS</b>				
TDPR-002	1	Panhard Rod (14mm Sleeve)		Up to Chassis #2A626645

### REAR SUSPENSION

<b>SHOCK ABSORBERS</b>				
FC41397	2	41mm Foam Cell Shocks		Suits up to 30mm Lift
BM401397	2	40mm Adjustable Shock		<b>Fit this part number if the lower rubber bushes are conical in shape &amp; fit into a metal housing.</b>
BMX1397/2	2	45mm Adjustable Shock		
TDR1397B	2	53mm 'Ralph' Shock		
FC41398	2	41mm Foam Cell Shocks		
BM401398	2	40mm Adjustable Shock		<b>Fit this part number if the lower rubber bushes are flat &amp; approx. 45mm in diameter</b>
BMX1398/2	2	45mm Adjustable Shock		
TDR1398	2	53mm 'Ralph' Shock		
<b>COIL SPRINGS</b>				
TDC518	2	0-300kg Load		30mm Lift
TDC518H	2	<b>CONSTANT</b> 300Kg Load		30mm Lift

### REPLACEMENT BUSHINGS

QUANTITY PER SHOCK				
TW967	2	Suits Bottom & Top Front Pin		Pin Style Bushing #1397 Shocks
415024	1	Suits Top Front Eye		Eyering Bushing #1397 Shocks
ADJ00191	1	Suits Top Rear Eye		Eyering Bushing #1398 Shocks
TW957	2	Suits Bottom Rear Pin		Pin Style Bushing #1398 Shocks
TW957	4	Suits Front Shock Top & Bottom		Pin Style Bushing #1049 Shocks





Vehicle fitment sheet must be completed when suspension fitted. Failure to do so may affect warranty.  
Fitment sheet can be found on page 200 of this catalogue

# LAND ROVER

DISCOVERY

4/91-99  
SERIES I

## COMPLETE KIT PRICE REFERENCE

SHOCK CHOICE	SPRING CHOICE	RRP inc GST	CONTENTS
<p><b>41mm Foam Cell</b></p> <p><u>Includes</u> 2x Front shocks 2x Rear Shocks 2x Front Coils 2x Rear Coils</p>	ANY		
<p><b>40mm Adjustable</b></p> <p><u>Includes</u> 2x Front shocks 2x Rear Shocks 2x Front Coils 2x Rear Coils</p>	ANY		
<p><b>45mm Big Bore Adjustable</b></p> <p><u>Includes</u> 2x Front shocks 2x Rear Shocks 2x Front Coils 2x Rear Coils</p>	ANY		
<p><b>53mm 'Ralph' Big Bore</b></p> <p><u>Includes</u> 2x Front shocks 2x Rear Shocks 2x Front Coils 2x Rear Coils</p>	ANY		

Freight should be added where required. When determining spring choice, include only permanent accessories & weights. Towing requirements are not included in constant load determination

P: (02) 9672 8899 | F: (02) 9672 8099



# LAND ROVER

## DISCOVERY

SERIES II (3/99 - 4/05)

SERIES III (4/05-2009)



### FRONT SUSPENSION

**ESTIMATED LIFT: 35mm**

PART NO.	QTY	DESCRIPTION	RRP inc GST	NOTES
<b>SHOCK ABSORBERS</b>				
FC41043	2	41mm Foam Cell Shock		Suits up to 35mm Lift ( <b>S2 ONLY</b> )
BM401043	2	40mm Adjustable Shock		Suits up to 35mm Lift ( <b>S2 ONLY</b> )
<b>COIL SPRINGS</b>				
TDC530	2	35mm Lift Spring		Suits <b>S2</b> with Bar
TDC530H	2	35mm Lift Spring		Suits <b>S2</b> with Bar & Winch
TDC545	2	40mm Lift Spring		Suits <b>S3</b> with Bar
TDC545H	2	40mm Lift Spring		Suits <b>S3</b> with Bar & Winch
<b>STEERING DAMPERS</b>				
EXT5003	1	H/Duty Steering Damper		( <b>S2 ONLY</b> )
SS5003-P/S	1	Return to Centre Damper		( <b>S2 ONLY</b> ) Power Steering
SV5003	1	9 Stage Adjustable Damper		( <b>S2 ONLY</b> )

### REAR SUSPENSION

<b>SHOCK ABSORBERS</b>				
FC41396	2	41mm Foam Cell Shock		Suits up to 35mm Lift ( <b>S2 ONLY</b> )
BM401396	2	40mm Adjustable Shock		Suits up to 35mm Lift ( <b>S2 ONLY</b> )
<b>COIL SPRINGS</b>				
TDC508	2	0-300kg Load		35mm Lift ( <b>S2 ONLY</b> )
TDC508H	2	<b>CONSTANT</b> 300Kg Load		35mm Lift ( <b>S2 ONLY</b> )
TDC546	2	0-300kg Load		40mm Lift ( <b>S3 ONLY</b> )
TDC546H	2	<b>CONSTANT</b> 300Kg Load		40mm Lift ( <b>S3 ONLY</b> )

**PLEASE TAKE CAREFUL NOTE OF PARTS SUITABILITY FOR SERIES II AND SERIES III  
SERIES II PARTS ARE NOT COMPATIBLE WITH SERIES III VEHICLES**

### COMPLETE KIT PRICE REFERENCE

SHOCK CHOICE	SPRING CHOICE	RRP inc GST	CONTENTS
41mm Foam Cell	All \$ 135 Coils		
	\$ 165 Rear Coils		
9 Stage Adjustable	All \$ 135 Coils		
	\$165 Rear Coils		
<p><b>Includes</b> 4 x Coil Springs      4 x Shocks</p>			

Vehicle fitment sheet must be completed when suspension fitted. Failure to do so may affect warranty.  
Fitment sheet can be found on page 200 of this catalogue





# LAND ROVER

## RANGE ROVER

6/72-4/95

### NON AIR SUSPENSION

#### FRONT SUSPENSION

**ESTIMATED LIFT: 35 mm**

PART NO.	QTY	DESCRIPTION	RRP inc GST	NOTES
<b>SHOCK ABSORBERS</b>				
FC41049	2	41mm Foam Cell Shock		Suits up to 35mm Lift
BM401049	2	40mm Adjustable Shock		<b>Suits all models without Air Suspension (6/72-94)</b>
BMX1049/2	2	45mm Adjustable Shock		
TDR1049B	2	53mm 'Ralph' Shock		
<b>COIL SPRINGS (Non Air Suspension Models Only)</b>				
TDC501	2	O.E Height Spring		Suits Petrol with Bar
TDC505	2	35mm Lift Spring		Suits Diesel with Bar
TDC504	2	35mm Lift Spring		Suits All with Bar & Winch
<b>STEERING DAMPERS</b>				
EXT5000	1	H/Duty Steering Damper		Power Steering
SS5000-P/S	1	Return to Centre Damper		
SV5000	1	9 Stage Adjustable Damper		
<b>PANHARD RODS</b>				
TDPR-002	1	Panhard Rod (14mm Sleeve)		Up to Chassis #2A626645
TDPR-018	1	Panhard Rod (16mm Sleeve)		

#### REAR SUSPENSION

<b>SHOCK ABSORBERS</b>				
FC41398	2	41mm Foam Cell Shock		Suits up to 35mm Lift
BM401398	2	40mm Adjustable Shock		<b>Suits all models without Air Suspension (6/72-94)</b>
BMX1398/2	2	45mm Adjustable Shock		
TDR1398	2	53mm 'Ralph' Shock		
<b>COIL SPRINGS</b>				
TDC502	2	0-300kg Load		Suits OE Height Only
TDC504	2	0-300kg Load		35mm Lift
TDC508	2	<b>CONSTANT</b> 300Kg Load		35mm Lift
TDC508H	2	<b>CONSTANT</b> 500Kg Load		35mm Lift

**COMPLETE KIT PRICE REFERENCE** FOR REPLACEMENT BUSHING PART NUMBERS, PLEASE SEE LAND ROVER DEFENDER 110 COUNTY ON PAGE 53

SHOCK CHOICE	SPRING CHOICE	RRP inc GST	CONTENTS
41mm Foam Cell	ANY		
9 Stage Adjustable	ANY		
9 Stage Adjustable 45mm Big Bore	ANY		
53mm 'Ralph'	ANY		
<b>Includes</b> 4 x Coil Springs    4 x Shocks			

Freight should be added where required. When determining spring choice, include only permanent accessories & weights. Towing requirements are not included in constant load determination

# LAND ROVER

## RANGE ROVER

5/95-00

WITH AIR SUSPENSION



### FRONT SUSPENSION

### ESTIMATED LIFT: AIR SYSTEM

PART NO.	QTY	DESCRIPTION	RRP inc GST	NOTES
<b>SHOCK ABSORBERS</b>				
FC41008	2	41mm Foam Cell Shock		Suits up to 35mm Lift
BM401008	2	40mm Adjustable Shock		<b>Suits all models with Air Suspension (5/95-00)</b>
BMX1008/2	2	45mm Adjustable Shock		
TDR1008	2	53mm 'Ralph' Shock		
<b>STEERING DAMPERS</b>				
EXT5000	1	H/Duty Steering Damper		Power Steering
SS5000-P/S	1	Return to Centre Damper		
SV5000	1	9 Stage Adjustable Damper		
<b>PANHARD RODS</b>				
TDPR-002	1	Panhard Rod (14mm Sleeve)		Up to Chassis #2A626645

### REAR SUSPENSION

<b>SHOCK ABSORBERS</b>				
FC41397	2	41mm Foam Cell Shock		Suits up to 35mm Lift
BM401397	2	40mm Adjustable Shock		<b>Suits all models with Air Suspension (5/95-00)</b>
BMX1397/2	2	45mm Adjustable Shock		
TDR1397	2	53mm 'Ralph' Shock		
<b>REPLACEMENT BUSHINGS</b>				
<b>QUANTITY PER SHOCK</b>				
TW957	2	Suits Top & Bottom Front Pin		Pin Style Bushing #1008 Shocks
415024	1	Suits Top Rear Eye		Eyering Bushing #1397 Shocks
TW967	2	Suits Bottom Rear Pin		Pin Style Bushing #1397 Shocks

Vehicle fitment sheet must be completed when suspension fitted. Failure to do so may affect warranty.  
Fitment sheet can be found on page 200 of this catalogue

# LADA

## NIVA

7/93-96  
ALL



### FRONT SUSPENSION

**ESTIMATED LIFT: 25 mm**

PART NO.	QTY	DESCRIPTION	RRP inc GST	NOTES
<b>SHOCK ABSORBERS</b>				
BD2006T	2	35mm Nitro Gas Shocks		Suits up to 25mm Lift
<b>COIL SPRINGS</b>				
TDC402	2	25mm Lift Spring		All Applications

### REAR SUSPENSION

<b>SHOCK ABSORBERS</b>				
BD3020T	2	35mm Nitro Gas Shocks		Suits up to 25mm Lift
<b>COIL SPRINGS</b>				
TDC403	2	25mm Lift Spring		All Applications

### REPLACEMENT BUSHINGS

QUANTITY PER SHOCK				
TW959	4	Suits Top Front Pin		Pin Style Bush
412773	1	Suits Bottom Front Eye		Eyering Bush
404702	1	Suits Top Rear Eye		Eyering Bush
4W-SPF420-02	1	Suits Bottom Rear Eye		Eye Style Bus

### COMPLETE KIT PRICE REFERENCE

SHOCK CHOICE	SPRING CHOICE	RRP inc GST	CONTENTS
35mm Nitro Gas	ANY		
<b>Includes</b> 4 x Coil Springs      4 x Shocks			

Freight should be added where required. When determining spring choice, include only permanent accessories & weights. Towing requirements are not included in constant load determination

# MAZDA

B2500, B2600

5/87-10/06

PC, PD, PE, PG, PH



**ESTIMATED LIFT: 40mm**

PART NO.	QTY	DESCRIPTION	RRP inc GST	NOTES
<b>SHOCK ABSORBERS</b>				
FC42051B	2	41mm Foam Cell Shock		Suits up to 40mm Lift
TDSK-020	1	Shock Mount Strengthening Kit		Top Pin Mount Bracket
<b>Please Note: - Failure to fit TDSK-020 will cause top mount failure. Fitting instructions at <a href="http://toughdog.com.au">toughdog.com.au</a></b>				
<b>TORSION BARS</b>				
4WTB-1546	1	Replacement Torsion Bars		26mm/926mm
<b>Adjust Torsion bars after fitting shocks - Ensure a minimum of 60mm Droop is Maintained</b>				

## REAR SUSPENSION

<b>SHOCK ABSORBERS</b>				
BD1232T	2	35mm Nitrogen Gas Shock		Suits Up to 40mm Lift
FC41232	2	41mm Foam Cell Shock		Suits Up to 40mm Lift
BM401232	2	40mm 9 Stage Adjustable		Suits Up to 40mm Lift
<b>LEAF SPRINGS</b>				
FS365	2	0-300kg Load		40mm Lift
FS367	2	<b>CONSTANT</b> 300Kg Load		40mm Lift
<b>COMPONENTS</b>				
TDUK-034	1	Urethane Shackle Bushing Kit		
TDUB-005	2	U-Bolt Kit		

## REPLACEMENT BUSHINGS

<b>QUANTITY PER SHOCK</b>				
TW959 + TW961	1 (ea)	Suits Top Front Pin		Pin Style Bushing
412772	1	Suits Bottom Front & Rear Eye		Eyering Bushing
ADJ00191	1	Suits Top Rear Eyering		Suit Foam Cell Shocks
4W-SPF420-02	1	Suits Bottom Rear Eyering		
230100	1	Suits Top Rear Eyering		Suit 40mm Adjustable Shocks
230002	1	Suits Bottom Rear Eyering		

## COMPLETE KIT PRICE REFERENCE

SHOCK CHOICE	SPRING CHOICE	RRP inc GST	CONTENTS
<b>Foam Cell Front Nitro gas Rear</b>	<b>0-300KG Constant 300kg</b>		
<b>41mm Foam Cell</b>	<b>0-300KG Constant 300kg</b>		
<b>Foam Cell Front Adjustable Rear</b>	<b>0-300KG Constant 300kg</b>		
<b>Includes</b> 2 x Leaf Springs    4 x Shocks    1 x Urethane Kits 2 x U-Bolt Kits 1 x Shock Strengthening Kit			

Vehicle fitment sheet must be completed when suspension fitted. Failure to do so may affect warranty.  
Fitment sheet can be found on page 200 of this catalogue



# MAZDA

## BT-50

11/06-10/11  
B2500, B3000

### FRONT SUSPENSION

**ESTIMATED LIFT: 45 mm**

PART NO.	QTY	DESCRIPTION	RRP inc GST	NOTES
<b>SHOCK ABSORBERS</b>				
FC42051B	2	41mm Foam Cell Shock		Suits up to 40mm Lift
TDSK-020	1	Shock Mount Strengthening Kit		Top Pin Mount Bracket
<b>Please Note: - Failure to fit TDSK-020 will cause top mount failure. Fitting instructions at <a href="http://toughdog.com.au">toughdog.com.au</a></b>				
<b>TORSION BARS</b>				
4WTB-1440	1	Replacement Torsion Bars		27mm/1028mm
<b>Adjust Torsion bars after fitting shocks - Ensure a minimum of 60mm Droop is Maintained</b>				

### REAR SUSPENSION

<b>SHOCK ABSORBERS</b>				
BD1232T	2	35mm Nitrogen Gas Shock		Suits Up to 45mm Lift
FC41232	2	41mm Foam Cell Shock		Suits Up to 45mm Lift
BM401232	2	40mm 9 Stage Adjustable		Suits Up to 45mm Lift
<b>LEAF SPRINGS</b>				
FS368C	2	0-300kg Load		45mm Lift
FS368L	2	<b>CONSTANT</b> 300Kg Load		45mm Lift
<b>COMPONENTS</b>				
TDUK-069	1	Urethane Shackle Bushing Kit		
TDUB-040	2	U-Bolt Kit		Suits FS368C only
TDUB-039	2	U-Bolt Kit		Suits FS368L only
TDGS-386/1	1	Greasable Shackle Kit		
TDGP-668	1	Greasable Pin Kit		
<b>AIR ASSIST BAGS</b>				
TDAA-101	1	Bellows bag kit		Suits 45mm Lift

**Replacement bushes listed on p 26**

### COMPLETE KIT PRICE REFERENCE

SHOCK CHOICE	SPRING CHOICE	RRP inc GST	CONTENTS
Foam Cell Front Nitro gas Rear	0-300KG		<p><b>Includes</b> 2 x Leaf Springs 4 x Shocks 1 x Urethane Kit 2 x U-Bolt Kits 1 x Shock Mount Kit</p>
41mm Foam Cell	0-300KG		
	Constant 300kg		
Foam Cell Front Adjustable Rear	0-300KG		
	Constant 300kg		

*Freight should be added where required. When determining spring choice, include only permanent accessories & weights. Towing requirements are not included in constant load determination*

**P: (02) 9672 8899 | F: (02) 9672 8099**



# MAZDA

BT-50

11/11 On

MY11 On



## FRONT SUSPENSION

**ESTIMATED LIFT: 40mm**

PART NO.	QTY	DESCRIPTION	RRP inc GST	NOTES
<b>SHOCK ABSORBERS</b>				
FC404500	2	40mm Foam Cell Strut		
BM404500	2	40mm Adjustable Strut		9 Stage Adjustable
<b>COIL SPRINGS</b>				
TDC451	2	40mm Lift Spring		Petrol/Diesel/Bar
TDC451HL	2	40mm Lift Spring		Petrol/Diesel/Bar/Winch
<b>COMPLETE STRUT ASSEMBLY</b>				
MAZ-001	2	BM404500/TDC451		Petrol/Diesel/Bar
MAZ-002	2	BM404500/TDC451HL		Petrol/Diesel/Bar/Winch
MAZ-003	2	FC404500/TDC451		Petrol/Diesel/Bar
MAZ-004	2	FC404500/TDC451HL		Petrol/Diesel/Bar/Winch
<b>REPLACEMENT STRUT TOP</b>				
MAZ-4051	2	Strut Top		Replacement Strut Top

## REAR SUSPENSION

<b>SHOCK ABSORBERS</b>				
BD1232T	2	35mm Nitrogen Gas Shock		Up to 40mm Lift ( <b>Comfort Use</b> )
FC41232	2	41mm Foam Cell Shock		Suits Up to 40mm Lift
BM401232	2	40mm 9 Stage Adjustable		Suits Up to 40mm Lift
<b>LEAF SPRINGS</b>				
FS369C	2	0-300kg Load		40mm Lift
FS369L	2	<b>CONSTANT</b> 300Kg Load		40mm Lift
FS369LL	2	<b>CONSTANT</b> 500Kg Load		40mm Lift
<b>COMPONENTS</b>				
TDUK-070	1	Urethane Shackle Bushing Kit		
TDUB-039	2	U-Bolt Kit		Suits FS369L & LL Spring
TDUB-040	2	U-Bolt Kit		Suits FS369C Spring Only
TDGS-390	1	Greasable Shackle Kit		
TDGP-668	1	Greasable Pin Kit		
TDSP-007	1	Transmission Spacer Kit		Must Be fitted to All Lift Kits
<b>AIR ASSIST BAGS</b>				
TDAA-102	1	Bellows bag kit		Suits 40mm Lift

## REPLACEMENT BUSHINGS

QUANTITY PER SHOCK				
MAZ-4051	1	Replacement Strut Top		Available As Complete Unit Only
ADJ00305	1	Suits Bottom Front Eye		Eyering Bonded Bushing
ADJ00191	1	Suits Top Rear Eyering		Suit Foam Cell Shocks
4W-SPF420-02	1	Suits Bottom Rear Eyering		
230100	1	Suits Top Rear Eyering		Suit 40mm Adjustable Shocks
230002	1	Suits Bottom Rear Eyering		

Vehicle fitment sheet must be completed when suspension fitted. Failure to do so may affect warranty.





Fitment sheet can be found on page 200 of this catalogue

**Note: Transmission spacer fitting instructions available at [toughdog.com.au](http://toughdog.com.au)**

# MAZDA

**BT-50**  
**11/11 On**  
**MY11 On**

## COMPLETE KIT PRICE REFERENCE

SHOCK CHOICE	SPRING CHOICE	RRP inc GST	CONTENTS
<b>Foam Cell Struts Require Assembly</b> <b>Includes</b> 2x Front Struts 2x Rear Shocks 2x Front Coils 2x Leaf Springs 1x Urethane Kit 2x U-Bolt Kits 1x Transmission Spacer	<b>FS369C</b> (Foam Front Gas Rear)		
	<b>FS369C</b> (Foam Cell All)  <b>FS369L</b> <b>CONSTANT 300KG</b>  <b>FC369LL</b> <b>CONSTANT 500KG</b>		
<b>Foam Cell Complete Assembly Struts</b> <b>Includes</b> 2x Front Strut Assy 2x Rear Shocks 2x Leaf Springs 1x Urethane Kit 2x U-Bolt Kits 1x Transmission Space	<b>FS369C</b> (Foam Front Gas Rear)		
	<b>FS369C</b> (Foam Cell All)  <b>FS369L</b> <b>CONSTANT 300KG</b>  <b>FS369LL</b> <b>CONSTANT 500KG</b>		
<b>40mm Adjustable Struts Require Assembly</b> <b>Includes</b> 2x Front Struts 2x Rear Shocks 2x Front Coils 2x Leaf Springs 1x Urethane Kit 2x U-Bolt Kits 1x Transmission Spacer	<b>FS369C</b> 0-300KG		
	<b>FS369L</b> <b>CONSTANT 300KG</b>  <b>FS369LL</b> <b>CONSTANT 500KG</b>		
<b>40mm Adjustable Complete Assembly Struts</b> <b>Includes</b> 2x Front Strut Assy 2x Rear Shocks 2x Leaf Springs 1x Urethane Kit 2x U-Bolt Kits 1x Transmission Spacer	<b>FS369C</b> 0-300KG		
	<b>FS369L</b> <b>CONSTANT 300KG</b>  <b>FS369LL</b> <b>CONSTANT 500KG</b>		

*Freight should be added where required. When determining spring choice, include only permanent accessories & weights. Towing requirements are not included in constant load determination*

# MERCEDES-BENZ

## X-CLASS UTE

2017 On

X250D/X350D

### FRONT SUSPENSION

**ESTIMATED LIFT: 35mm**

PART NO.	QTY	DESCRIPTION	RRP inc GST	NOTES
<b>SHOCK ABSORBERS</b>				
FC404925	2	40mm Foam Cell Strut		
BM404925	2	40mm Adjustable Strut		9 Stage Adjustable
<b>COIL SPRINGS</b>				
TDC1008	2	35mm Lift Spring		Suits vehicles with no accessories
TDC1009	2	35mm Lift Spring		Suits with Bar or Bar+Winch
<b>COMPLETE STRUT ASSEMBLY</b>				
MER-001	2	BM404925/TDC1008		Diesel with no accessories
MER-002	2	BM404925/TDC1009		Diesel Bar or Bar+Winch
MER-003	2	FC404925/TDC1008		Diesel with no accessories
MER-004	2	FC404925/TDC1009		Diesel Bar or Bar+Winch
<b>REPLACEMENT STRUT TOP</b>				
NIS-3030	2	Strut Top		Replacement Strut Top

### REAR SUSPENSION

<b>SHOCK ABSORBERS</b>				
FC41369	2	41mm Foam Cell Shock		Up to 35mm Lift
BM401369	2	40mm 9 Stage Adjustable		Up to 35mm Lift
<b>COIL SPRINGS</b>				
TDC774	2	0-300kg Load		35mm Lift
TDC774H	2	<b>CONSTANT</b> 300Kg Load		35mm Lift
TDC774VHL	2	<b>CONSTANT</b> 500Kg Load		35mm Lift
<b>COMPONENTS</b>				
TDPR-300	1	Adjustable Panhard Rod		
<b>AIR ASSIST BAGS</b>				
TDAA-007	1	Coil insert bag kit		Suits 35mm Lift

### REPLACEMENT BUSHINGS

QUANTITY PER SHOCK				
NIS-3030	1	Replacement Strut Top		Available As Complete Unit Only
ADJ300/40	1	Suits Bottom Front Eying		Eying Bonded Bushing
404702	1	Suits Rear Top Eying		Eying Bushing
TW040/14	1	Suits Rear Bottom Eying		Eying Bushing

Vehicle fitment sheet must be completed when suspension fitted. Failure to do so may affect warranty.  
Fitment sheet can be found on page 200 of this catalogue







# MERCEDES-BENZ

X-CLASS UTE

2017 On

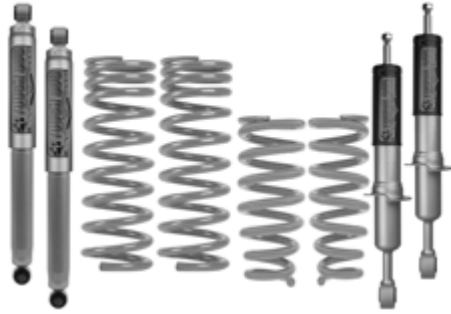
X250D/X350D

## COMPLETE KIT PRICE REFERENCE

SHOCK CHOICE	SPRING CHOICE	RRP inc GST	CONTENTS
<p><b>Foam Cell Struts Require Assembly</b></p> <p><b>Includes</b> 2x Front Struts 2x Rear Shocks 2x Front Coils 2x Rear Coils</p>	<p>TDC 0-300KG Spring</p> <p>TDC CONSTANT 300KG Spring</p> <p>TDC CONSTANT 500KG Spring</p>		
<p><b>Foam Cell Complete Assembly Struts</b></p> <p><b>Includes</b> 2x Front Strut Assembly 2x Rear Shocks 2x Rear Coils</p>	<p>TDC 0-300KG Spring</p> <p>TDC CONSTANT 300KG Spring</p> <p>TDC CONSTANT 500KG Spring</p>		
<p><b>40mm Adjustable Struts Require Assembly</b></p> <p><b>Includes</b> 2x Front Struts 2x Rear Shocks 2x Front Coils 2x Rear Coils</p>	<p>TDC 0-300KG Spring</p> <p>TDC CONSTANT 300KG Spring</p> <p>TDC CONSTANT 500KG Spring</p>		
<p><b>40mm Adjustable Complete Assembly Struts</b></p> <p><b>Includes</b> 2x Front Strut Assembly 2x Rear Shocks 2x Rear Coils</p>	<p>TDC 0-300KG Spring</p> <p>TDC CONSTANT 300KG Spring</p> <p>TDC CONSTANT 500KG Spring</p>		

Freight should be added where required. When determining spring choice, include only permanent accessories & weights. Towing requirements are not included in constant load determination

# MITSUBISHI

## CHALLENGER

3/98-00

PA - LEAF REAR



### FRONT SUSPENSION

**ESTIMATED LIFT: 35mm**

PART NO.	QTY	DESCRIPTION	RRP inc GST	NOTES
<b>SHOCK ABSORBERS</b>				
FC42057B	2	41mm Foam Cell Shock		Suits up to 35mm Lift
<b>TORSION BARS</b>				
4WTB-0203	1	Replacement Torsion Bars		27.5mm/1307mm
<b>Adjust Torsion bars after fitting shocks - Ensure a minimum of 60mm Droop is Maintained</b>				

### REAR SUSPENSION

<b>SHOCK ABSORBERS</b>				
BD1382T	2	35mm Nitrogen Gas Shock		Suits Up to 35mm Lift
FC41382	2	41mm Foam Cell Shock		Suits Up to 35mm Lift
BM401382	2	40mm 9 Stage Adjustable		Suits Up to 35mm Lift
<b>LEAF SPRINGS</b>				
FS021	2	0-300kg Load		35mm Lift
<b>COMPONENTS</b>				
TDSK-023	1	Anti inversion bracket kit		Must be fitted with all leaf springs
TDUK-066/31	1	Urethane Shackle Bushing Kit		
TDUB-006	2	U-Bolt Kit		

### REPLACEMENT BUSHINGS

QUANTITY PER SHOCK				
TW959	2	Suits Top Front Pin		Pin Style Bushing
412772	1	Suits Bottom Front Eye		Eyering Bonded Bushing
404702	2	Suits Top & Bottom Rear Eyering		Eyering Bushing

### COMPLETE KIT PRICE REFERENCE

SHOCK CHOICE	SPRING CHOICE	RRP inc GST	CONTENTS
Foam Cell Front Nitro gas Rear	0-300KG		
41mm Foam Cell	0-300KG		
Foam Cell Front Adjustable Rear	0-300KG		
<b>Includes</b> 2 x Leaf Springs      4 x Shocks      1 x Urethane Kit 2 x U-Bolt Kits      1 x Anti Inversion Kit			

Vehicle fitment sheet must be completed when suspension fitted. Failure to do so may affect warranty.  
Fitment sheet can be found on page 200 of this catalogue



# MITSUBISHI

## CHALLENGER

8/00-08  
PA II - COIL REAR

### FRONT SUSPENSION

**ESTIMATED LIFT: 35 mm**

PART NO.	QTY	DESCRIPTION	RRP inc GST	NOTES
<b>SHOCK ABSORBERS</b>				
FC42057B	2	41mm Foam Cell Shock		Suits up to 35mm Lift
<b>TORSION BARS</b>				
4WTB-0203	1	Replacement Torsion Bars		27.5mm/1307mm
<b>Adjust Torsion bars after fitting shocks - Ensure a minimum of 60mm Droop is Maintained</b>				

### REAR SUSPENSION

<b>SHOCK ABSORBERS</b>				
FC41439	2	41mm Foam Cell Shock		Suits Up to 35mm Lift
BM401439	2	40mm 9 Stage Adjustable		Suits Up to 35mm Lift
<b>COIL SPRINGS</b>				
TDC640	2	0-300kg Load		35mm Lift
TDC632SL	2	<b>CONSTANT</b> 300Kg Load		35mm Lift

### REPLACEMENT BUSHINGS

QUANTITY PER SHOCK				
TW959	2	Suits Top Front Pin		Pin Style Bushing
412772	1	Suits Bottom Front Eye		Eyering Bonded Bushing
404702	1	Suits Top Rear Eyering		Eyering Bushing
TW038/16	1	Suits Bottom Rear Eye		

### COMPLETE KIT PRICE REFERENCE

SHOCK CHOICE	SPRING CHOICE	RRP inc GST	CONTENTS
41mm Foam Cell	0-300KG		
Foam Cell Front Adjustable Rear	0-300KG		
<b>Includes</b> 2 x Coil Springs      4 x Shocks			

Freight should be added where required. When determining spring choice, include only permanent accessories & weights. Towing requirements are not included in constant load determination

# MITSUBISHI

## PB CHALLENGER/PAJERO SPORT

09-2015  
MY10, 11LS & XLS



### FRONT SUSPENSION

**ESTIMATED LIFT: 25mm**

PART NO.	QTY	DESCRIPTION	RRP inc GST	NOTES
<b>SHOCK ABSORBERS</b>				
FC404800	2	40mm Foam Cell Strut		
BM404800	2	40mm Adjustable Strut		9 Stage Adjustable
<b>COIL SPRINGS</b>				
TDC670	2	25mm Lift Spring		Petrol/Diesel/Bar
TDC670H	2	25mm Lift Spring		Petrol/Diesel/Bar/Winch
<b>COMPLETE STRUT ASSEMBLY</b>				
MIT-060/01	2	BM404800/TDC670		Petrol/Diesel/Bar
MIT-060/02	2	BM404800/TDC670H		Petrol/Diesel/Bar/Winch
MIT-060/03	2	FC404800/TDC670		Petrol/Diesel/Bar
MIT-060/04	2	FC404800/TDC670H		Petrol/Diesel/Bar/Winch
<b>REPLACEMENT STRUT TOP</b>				
MIT-4040	2	Strut Top		Replacement Strut Top

### REAR SUSPENSION

<b>SHOCK ABSORBERS</b>				
FC41440B	2	41mm Foam Cell Shock		Suits Up to 25mm Lift
BM401440	2	40mm 9 Stage Adjustable		Suits Up to 25mm Lift
<b>COIL SPRINGS</b>				
TDC636L	2	0-300kg Load		25mm Lift
TDC636HL	2	<b>CONSTANT</b> 300Kg Load		25mm Lift
<b>Use of CONSTANT load spring without load will result in tailshaft vibrations.</b>				

### REPLACEMENT BUSHINGS

QUANTITY PER SHOCK				
MIT-4040	1	Replacement Strut Top		Available As Complete Unit Only
ADJ00300/50	1	Suits Bottom Front Eye		Eyering Bonded Bushing
404702	1	Suits Top Rear Eyering		Eyering Bushing
TW038/16	1	Suits Bottom Rear Eye		Eyering Bushing





Vehicle fitment sheet must be completed when suspension fitted. Failure to do so may affect warranty.  
Fitment sheet can be found on page 200 of this catalogue

# MITSUBISHI

## PB CHALLENGER/PAJERO SPORT

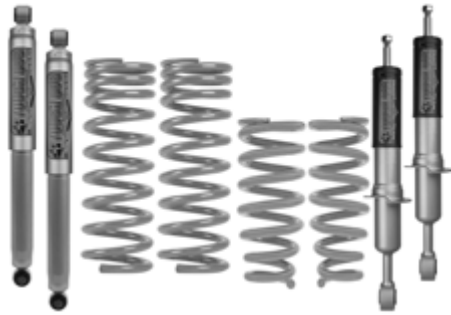
09 On  
MY10. 11LS & XLS

### COMPLETE KIT PRICE REFERENCE

SHOCK CHOICE	SPRING CHOICE	RRP inc GST	CONTENTS
<p style="text-align: center;"><b>Foam Cell Struts Require Assembly</b></p> <p style="text-align: center;"><b>Includes</b> 2x Front Struts 2x Rear Shocks 4x Coil Springs</p>	ANY		
<p style="text-align: center;"><b>Foam Cell Complete Assembly Struts</b></p> <p style="text-align: center;"><b>Includes</b> 2x Front Strut Assy 2x Rear Shocks 2x Rear Coils</p>	ANY		
<p style="text-align: center;"><b>40mm Adjustable Struts Require Assembly</b></p> <p style="text-align: center;"><b>Includes</b> 2x Front Struts 2x Rear Shocks 4x Coil Springs</p>	ANY		
<p style="text-align: center;"><b>40mm Adjustable Complete Assembly Struts</b></p> <p style="text-align: center;"><b>Includes</b> 2x Front Strut Assy 2x Rear Shocks 2x Rear Coils</p>	ANY		

*Freight should be added where required. When determining spring choice, include only permanent accessories & weights. Towing requirements are not included in constant load determination*

# MITSUBISHI

L200 4WD

5/79-86

MA, MB, MC, MD



## FRONT SUSPENSION

**ESTIMATED LIFT: 40mm**

PART NO.	QTY	DESCRIPTION	RRP inc GST	NOTES
<b>TORSION BARS</b>				
4WTB-1726	1	Replacement Torsion Bars		26mm/1277.5mm
<b>Adjust Torsion bars after fitting shocks - Ensure a minimum of 60mm Droop is Maintained</b>				

## REAR SUSPENSION

<b>SHOCK ABSORBERS</b>				
BD1382T	2	35mm Nitrogen Gas Shock		Suits OE Height
FC41382	2	41mm Foam Cell Shock		
BM401382	2	40mm 9 Stage Adjustable		
BD1388T	2	35mm Nitrogen Gas Shock		Suits 40mm Lift
FC41388	2	41mm Foam Cell Shock		
BM401388	2	40mm 9 Stage Adjustable		
<b>COMPONENTS</b>				
TDUK-021/35	1	Urethane Shackle Bushing Kit		
TDUB-006	2	U-Bolt Kit		

## REPLACEMENT BUSHINGS

<b>QUANTITY PER SHOCK</b>				
404702	2	Suits Top & Bottom Rear Eying		Eying Bushing

Vehicle fitment sheet must be completed when suspension fitted. Failure to do so may affect warranty.  
Fitment sheet can be found on page 200 of this catalogue



# mitsubishi

## L300 4WD

4/83-94

SC, SD, SE, SF, SG, SH

### FRONT SUSPENSION

**ESTIMATED LIFT: 40 mm**

PART NO.	QTY	DESCRIPTION	RRP inc GST	NOTES
<b>SHOCK ABSORBERS</b>				
BD2058T	2	35mm Nitro Gas Shock		
FC42058B	2	41mm Foam Cell Shock		Suits up to 40mm Lift
<b>TORSION BARS</b>				
4WTB-1726	1	Replacement Torsion Bars		26mm/1277.5mm - SC, SD, SE
<b>Adjust Torsion bars after fitting shocks - Ensure a minimum of 60mm Droop is Maintained</b>				

### REAR SUSPENSION

<b>SHOCK ABSORBERS</b>				
BD1366T	2	35mm Nitro Gas Shock		Suits OE Height SC, SD, SE (5/83-86) ONLY
FC41366	2	41mm Foam Cell Shock		
BM401366	2	40mm 9 Stage Adjustable		
BD1382T	2	35mm Nitro Gas Shock		Suits 40mm Lift SC, SD, SE (5/83-86) ONLY
FC41382	2	41mm Foam Cell Shock		
BM401382	2	40mm 9 Stage Adjustable		
BD1386T	2	35mm Nitro Gas Shock		Suits OE Height SF, SG, SH (10/86-94) ONLY
FC41386	2	41mm Foam Cell Shock		
BM401386	2	40mm 9 Stage Adjustable		
BD1400T	2	35mm Nitro Gas Shock		Suits 40mm Lift SF, SG, SH (10/86-94) ONLY
FC41400	2	41mm Foam Cell Shock		
BM401400	2	40mm 9 Stage Adjustable		
<b>COMPONENTS</b>				
TDUK-005	1	Urethane Shackle Bushing Kit		35mm Lift
TDUB-006	2	U-Bolt Kit		35mm Lift

### REPLACEMENT BUSHINGS

QUANTITY PER SHOCK				
TW959	2	Suits Top Front Pin		Pin Style Mount
404702	2	Suits Top & Bottom Rear Eying		Eying Bushing (#1366 & #1382)
404702	1	Suits Top & Bottom Rear Eying		Eying Bushing (#1386 & #1400)
TW959	2	Suits Bottom Rear Pin		Pin Style Mount (#1386 & #1400)
412772	1	Suits Bottom Front Eying		Eying Bushing (#42057B)

Freight should be added where required. When determining spring choice, include only permanent accessories & weights. Towing requirements are not included in constant load determination

**P: (02) 9672 8899 | F: (02) 9672 8099**



# MITSUBISHI

## PAJERO / MONTERO

7/83-91 (NA-NG) & 5/91-96

### LEAF REAR



## FRONT SUSPENSION

**ESTIMATED LIFT: 40mm**

PART NO.	QTY	DESCRIPTION	RRP inc GST	NOTES
<b>SHOCK ABSORBERS</b>				
FC42058B	2	41mm Foam Cell Shock (bar pin)		40mm Lift (7/83-91 ONLY)
FC42057B	2	41mm Foam Cell Shock (sleeve)		40mm Lift (5/91-96 ONLY)
<b>TORSION BARS</b>				
4WTB-1726	1	Replacement Torsion Bars		26mm/1277.5mm
<b>Adjust Torsion bars after fitting shocks - Ensure a minimum of 60mm Droop is Maintained</b>				
<b>STEERING DAMPERS</b>				
SS5013-P/S	1	Return to Centre Damper		Damper Mounts Present in Vehicle
SS5016-P/S	1	Return to Centre Damper		Mounts Not Present in Vehicle

## REAR SUSPENSION

<b>SHOCK ABSORBERS</b>				
FC41382	2	41mm Foam Cell Shock		Suits Up to 40mm Lift
BM401382	2	40mm 9 Stage Adjustable		Suits Up to 40mm Lift
<b>LEAF SPRINGS</b>				
FS021	2	0-300kg Load		40mm Lift
FS021H	2	<b>CONSTANT</b> 300Kg Load		40mm Lift
<b>COMPONENTS</b>				
TDUK-005	1	Urethane Shackle Bushing Kit		
TDUB-006	2	U-Bolt Kit		
TDGP-004	1	Greasable Pin Kit		
TDGS-900	1	Greasable Shackle Kit		

## REPLACEMENT BUSHINGS

QUANTITY PER SHOCK				
TW959	2	Suits Top Front Pin		Pin Style Bushing
404702	2	Suits Top & Bottom Rear Eying		Eying Bushing
412772	1	Suits Bottom Front Eying		Eying Bushing (#2057B ONLY)

## COMPLETE KIT PRICE REFERENCE

SHOCK CHOICE	SPRING CHOICE	RRP inc GST	CONTENTS
41mm Foam Cell	0-300KG		
	CONSTANT 300KG		
Foam Cell Front Adjustable Rear	0-300KG		
	CONSTANT 300KG		
<b>Includes</b> 2 x Leaf Springs      4 x Shocks 1 x Urethane Kits      2 x U-Bolt Kits			

Vehicle fitment sheet must be completed when suspension fitted. Failure to do so may affect warranty.  
Fitment sheet can be found on page 200 of this catalogue





# MITSUBISHI

## PAJERO / MONTERO

8/88-91 (NF-NG) & 5/91-00 (NH-NL)

### COIL REAR

## FRONT SUSPENSION

**ESTIMATED LIFT: 40 mm**

PART NO.	QTY	DESCRIPTION	RRP inc GST	NOTES
<b>SHOCK ABSORBERS</b>				
FC42058B	2	41mm Foam Cell Shock		40mm Lift (7/88-91 ONLY)
FC42057B	2	41mm Foam Cell Shock		40mm Lift (5/91-00 ONLY)
<b>TORSION BARS</b>				
4WTB-1726	1	Replacement Torsion Bars		26mm/1277.5mm
4WTB-0203	1	Replacement Torsion Bars		27.5mm/1307mm (NH, NJ, NK)
<b>Check bars first! - Adjust torsion bars after fitting shocks - Ensure a minimum of 60mm Droop is Maintained</b>				
<b>STEERING DAMPERS</b>				
SS5013-P/S	1	Return to Centre Damper		Damper Mounts Present in Vehicle
SS5016-P/S	1	Return to Centre Damper		Mounts Not Present in Vehicle

## REAR SUSPENSION

<b>SHOCK ABSORBERS</b>				
FC41439	2	41mm Foam Cell Shock		Up to 40mm Lift (7/88-91 ONLY)
BM401439	2	40mm 9 Stage Adjustable		Up to 40mm Lift (7/88-91 ONLY)
FC41170B	2	41mm Foam Cell Shock		Suits OE Height (5/91-00 ONLY)
BM401170	2	40mm 9 Stage Adjustable		Suits OE Height (5/91-00 ONLY)
FC41178B	2	41mm Foam Cell Shock		Up to 40mm Lift (5/91-00 ONLY)
BM401178	2	40mm 9 Stage Adjustable		Up to 40mm Lift (5/91-00 ONLY)
<b>COIL SPRINGS</b>				
TDC632SL	2	0-300kg Load		40mm Lift
TDC632L	2	<b>CONSTANT</b> 300Kg Load		40mm Lift

## REPLACEMENT BUSHINGS

QUANTITY PER SHOCK				
TW959	2	Suits Top Front Pin		Pin Style Bushing
412772	1	Suits Bottom Front Eye		Eyering Bushing (#2057B)
402267	2	Suits Top Pin Mount Rear		Eyering Bushing (#1170 & 78)

## COMPLETE KIT PRICE REFERENCE

SHOCK CHOICE	SPRING CHOICE	RRP inc GST	CONTENTS
41mm Foam Cell	0-300KG		
Foam Cell Front Adjustable Rear	0-300KG		
<b>Includes</b> 2 x Coil Springs      4 x Shocks			

Freight should be added where required. When determining spring choice, include only permanent accessories & weights. Towing requirements are not included in constant load determination

# MITSUBISHI

## PAJERO / MONTERO

5/00 on

NM onwards (LWB)



### FRONT SUSPENSION

**ESTIMATED LIFT: 40mm**

PART NO.	QTY	DESCRIPTION	RRP inc GST	NOTES
<b>SHOCK ABSORBERS</b>				
FC404300	2	40mm Foam Cell Strut		
BM404300	2	40mm Adjustable Strut		9 Stage Adjustable
<b>COIL SPRINGS</b>				
TDC631	2	OE Height Spring		
TDC633	2	40mm Lift Spring		Petrol/Bar
TDC633L	2	40mm Lift Spring		Diesel/Bar
TDC633H	2	40mm Lift Spring		Petrol/Diesel/Bar/Winch
<b>COMPLETE STRUT ASSEMBLY</b>				
MIT-050/01	2	BM404300/TDC633		Petrol/Bar
MIT-050/02	2	BM404300/TDC633L		Diesel/Bar
MIT-050/03	2	BM404300/TDC633H		Petrol/Diesel/Bar/Winch
MIT-050/04	2	FC404300/TDC633		Petrol/Bar
MIT-050/05	2	FC404300/TDC633L		Diesel/Bar
MIT-050/06	2	FC404300/TDC633H		Petrol/Diesel/Bar/Winch
<b>REPLACEMENT STRUT TOP</b>				
MIT-4038	2	Strut Top		Replacement Strut Top

### REAR SUSPENSION

<b>SHOCK ABSORBERS</b>				
FC41148	2	41mm Foam Cell Shock		Suits Up to 40mm Lift
<b>COIL SPRINGS</b>				
TDC635S	2	0-300kg Load		OE Height
TDC635	2	<b>CONSTANT</b> 300Kg Load		OE Height
TDC635	2	0-300kg Load		40mm Lift
TDC635H	2	<b>CONSTANT</b> 300Kg Load		40mm Lift
TDC635HH	2	<b>CONSTANT</b> 500Kg Load		40mm Lift
<b>AIR ASSIST BAGS</b>				
TDAA-006	1	Coil insert bag kit		suits 20mm Lift

### REPLACEMENT BUSHINGS

QUANTITY PER SHOCK				
MIT-4038	1	Replacement Strut Top		Available As Complete Unit Only
ADJ00300/40	1	Suits Bottom Front Eye		Eyering Bonded Bushing
TW959	2	Suits Top Rear Pin Style		Pin Style Bushing
TW-038/16	1	Suits Bottom Rear Eyering		Eyering Bushing

Vehicle fitment sheet must be completed when suspension fitted. Failure to do so may affect warranty.

Fitment sheet can be found on page 200 of this catalogue





Note: Front Strut Fitting Instructions available at [toughdog.com.au](http://toughdog.com.au)

# MITSUBISHI

## PAJERO / MONTERO

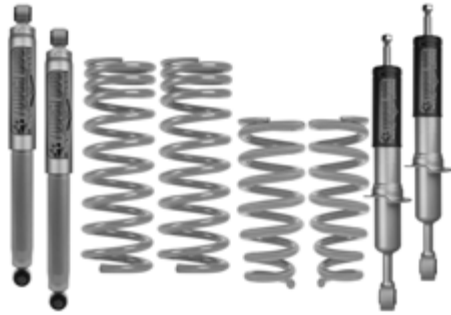
5/00 on  
NM onwards

### COMPLETE KIT PRICE REFERENCE

SHOCK CHOICE	SPRING CHOICE	RRP inc GST	CONTENTS
<p><b>Foam Cell Struts Require Assembly</b></p> <p><b>Includes</b> 2x Front Struts 2x Rear Shocks 4x Coil Springs</p>	ANY		
<p><b>Foam Cell Complete Assembly Struts</b></p> <p><b>Includes</b> 2x Front Strut Assy 2x Rear Shocks 2x Rear Coils</p>	ANY		
<p><b>Adjustable Front Foam Cell Rear Struts Require Assembly</b></p> <p><b>Includes</b> 2x Front Struts 2x Rear Shocks 4x Coil Springs</p>	ANY		
<p><b>Adjustable Front Foam Cell Rear Complete Assembly Struts</b></p> <p><b>Includes</b> 2x Front Strut Assy 2x Rear Shocks 2x Rear Coils</p>	ANY		

Freight should be added where required. When determining spring choice, include only permanent accessories & weights. Towing requirements are not included in constant load determination

# MITSUBISHI

## PAJERO / MONTERO

5/00 on - SHORT WHEEL BASE  
NM onwards (SWB)



### FRONT SUSPENSION

**ESTIMATED LIFT: 40mm**

PART NO.	QTY	DESCRIPTION	RRP inc GST	NOTES
<b>SHOCK ABSORBERS</b>				
FC404300	2	40mm Foam Cell Strut		
BM404300	2	40mm Adjustable Strut		9 Stage Adjustable
<b>COIL SPRINGS</b>				
TDC631	2	OE Height Spring		
TDC633	2	40mm Lift Spring		Petrol/Bar
TDC633L	2	40mm Lift Spring		Diesel/Bar
TDC633H	2	40mm Lift Spring		Petrol/Diesel/Bar/Winch
<b>COMPLETE STRUT ASSEMBLY</b>				
MIT-050/01	2	BM404300/TDC633		Petrol/Bar
MIT-050/02	2	BM404300/TDC633L		Diesel/Bar
MIT-050/03	2	BM404300/TDC633H		Petrol/Diesel/Bar/Winch
MIT-050/04	2	FC404300/TDC633		Petrol/Bar
MIT-050/05	2	FC404300/TDC633L		Diesel/Bar
MIT-050/06	2	FC404300/TDC633H		Petrol/Diesel/Bar/Winch
<b>REPLACEMENT STRUT TOP</b>				
MIT-4038	2	Strut Top		Replacement Strut Top

### REAR SUSPENSION

<b>SHOCK ABSORBERS</b>				
FC41148	2	41mm Foam Cell Shock		Suits Up to 40mm Lift
<b>COIL SPRINGS</b>				
TDC635S	2	0-300kg Load		40mm Lift
TDC635	2	<b>CONSTANT</b> 300Kg Load		40mm Lift
<b>AIR ASSIST BAGS</b>				
TDAA-006	1	Coil insert bag kit		Suits 20mm Lift

### REPLACEMENT BUSHINGS

QUANTITY PER SHOCK				
MIT-4038	1	Replacement Strut Top		Available As Complete Unit Only
ADJ00300/40	1	Suits Bottom Front Eye		Eyering Bonded Bushing
TW959	2	Suits Top Rear Pin Style		Pin Style Bushing
TW-038/16	1	Suits Bottom Rear Eyering		Eyering Bushing

Vehicle fitment sheet must be completed when suspension fitted. Failure to do so may affect warranty.  
Fitment sheet can be found on page 200 of this catalogue





Note: Front Strut Fitting Instructions available at [toughdog.com.au](http://toughdog.com.au)

# MITSUBISHI

## PAJERO / MONTERO

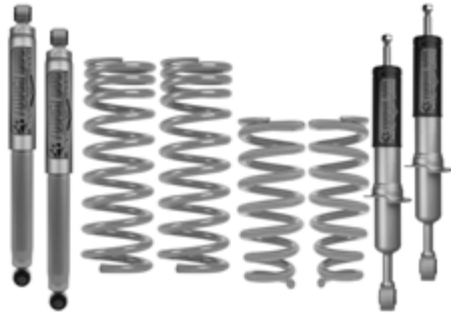
5/00 on - SHORT WHEEL BASE  
NM onwards

### COMPLETE KIT PRICE REFERENCE

SHOCK CHOICE	SPRING CHOICE	RRP inc GST	CONTENTS
<p><b>Foam Cell Struts Require Assembly</b></p> <p><b>Includes</b> 2x Front Struts 2x Rear Shocks 4x Coil Springs</p>	ANY		
<p><b>Foam Cell Complete Assembly Struts</b></p> <p><b>Includes</b> 2x Front Strut Assy 2x Rear Shocks 2x Rear Coils</p>	ANY		
<p><b>Adjustable Front Foam Cell Rear Struts Require Assembly</b></p> <p><b>Includes</b> 2x Front Struts 2x Rear Shocks 4x Coil Springs</p>	ANY		
<p><b>Adjustable Front Foam Cell Rear Complete Assembly Struts</b></p> <p><b>Includes</b> 2x Front Strut Assy 2x Rear Shocks 2x Rear Coils</p>	ANY		

Freight should be added where required. When determining spring choice, include only permanent accessories & weights. Towing requirements are not included in constant load determination

# MITSUBISHI

## PAJERO SPORT

2015 On

MY16 on



### FRONT SUSPENSION

**ESTIMATED LIFT: 20mm**

PART NO.	QTY	DESCRIPTION	RRP inc GST	NOTES
<b>SHOCK ABSORBERS</b>				
FC404800	2	40mm Foam Cell Strut		
BM404800	2	40mm Adjustable Strut		9 Stage Adjustable
<b>COIL SPRINGS</b>				
TDC681	2	20mm Lift Spring		Diesel
TDC681L	2	20mm Lift Spring		Diesel/Bar
TDC681HL	2	20mm Lift Spring		Diesel/Bar/Winch
<b>COMPLETE STRUT ASSEMBLY</b>				
MIT-061/01	2	BM404800/TDC681		Diesel
MIT-061/02	2	BM404800/TDC681L		Diesel/Bar
MIT-061/03	2	BM404800/TDC681HL		Diesel/Bar/Winch
MIT-061/05	2	FC404800/TDC681		Diesel
MIT-061/06	2	FC404800/TDC681L		Diesel/Bar
MIT-061/07	2	FC404800/TDC681HL		Diesel/Bar/Winch
<b>REPLACEMENT STRUT TOP</b>				
MIT-4040	2	Strut Top		Replacement Strut Top

### REAR SUSPENSION

<b>SHOCK ABSORBERS</b>				
FC41440B	2	41mm Foam Cell Shock		Suits Up to 20mm Lift
BM401440	2	40mm 9 Stage Adjustable		Suits Up to 20mm Lift
<b>COIL SPRINGS</b>				
TDC638L	2	0-300kg Load		20mm Lift
TDC638HL	2	<b>CONSTANT</b> 300Kg Load		20mm Lift
<b>Use of CONSTANT load spring without load will result in tailshaft vibrations.</b>				
<b>AIR ASSIST BAGS</b>				
TDAA-001	1	Coil insert bag kit		Suits 20mm Lift

### REPLACEMENT BUSHINGS

QUANTITY PER SHOCK				
MIT-4040	1	Replacement Strut Top		Available As Complete Unit Only
ADJ00300/50	1	Suits Bottom Front Eye		Eyering Bonded Bushing
404702	1	Suits Top Rear Eyering		Eyering Bushing
TW038/16	1	Suits Bottom Rear Eye		Eyering Bushing

Vehicle fitment sheet must be completed when suspension fitted. Failure to do so may affect warranty.





Fitment sheet can be found on page 200 of this catalogue

# MITSUBISHI

## PAJERO SPORT

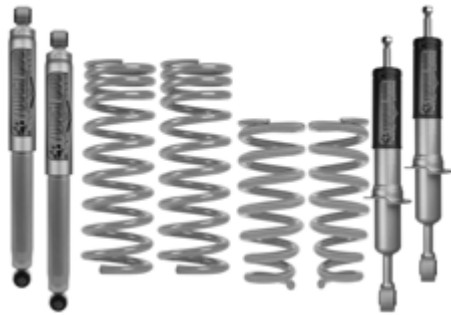
2015 on  
MY16 on

### COMPLETE KIT PRICE REFERENCE

SHOCK CHOICE	SPRING CHOICE	RRP inc GST	CONTENTS
<p><b>Foam Cell Struts Require Assembly</b></p> <p><u>Includes</u> 2x Front Struts 2x Rear Shocks 4x Coil Springs</p>	ANY		
<p><b>Foam Cell Complete Assembly Struts</b></p> <p><u>Includes</u> 2x Front Strut Assy 2x Rear Shocks 2x Rear Coils</p>	ANY		
<p><b>40mm Adjustable Struts Require Assembly</b></p> <p><u>Includes</u> 2x Front Struts 2x Rear Shocks 4x Coil Springs</p>	ANY		
<p><b>40mm Adjustable Complete Assembly Struts</b></p> <p><u>Includes</u> 2x Front Strut Assy 2x Rear Shocks 2x Rear Coils</p>	ANY		

Freight should be added where required. When determining spring choice, include only permanent accessories & weights. Towing requirements are not included in constant load determination

# MITSUBISHI

## TRITON

10/86-06

ME, MF, MG, MH, MK



### FRONT SUSPENSION

**ESTIMATED LIFT: 40mm**

PART NO.	QTY	DESCRIPTION	RRP inc GST	NOTES
<b>SHOCK ABSORBERS</b>				
BD2058T	2	35mm Nitro Gas Shock		Up to 40mm Lift (Up to MK)
BD2057T	2	35mm Nitro Gas Shock		Up to 40mm Lift (MK 10/96-06)
FC42057B	2	41mm Foam Cell Shock		Up to 40mm Lift (MK 10/96-06)
<b>TORSION BARS</b>				
4WTB-1726	1	Replacement Torsion Bars		26mm/1277.5mm
4WTB-1736	1	Replacement Torsion Bars		26mm/1370mm
<b>Check bars first! - Adjust torsion bars after fitting shocks - Ensure a minimum of 60mm Droop is Maintained</b>				

### REAR SUSPENSION

<b>SHOCK ABSORBERS</b>				
BD1388T	2	35mm Nitro Gas Shock		Suits Up to 40mm Lift
FC41388	2	41mm Foam Cell Shock		Suits Up to 40mm Lift
BM401388	2	40mm 9 Stage Adjustable		Suits Up to 40mm Lift
<b>LEAF SPRINGS</b>				
FS021	2	0-300kg Load		40mm Lift
FS021H	2	<b>CONSTANT</b> 300Kg Load		40mm Lift
<b>Some special edition models equipped with H/Duty leaf packs from factory - Check prior to ordering.</b>				
<b>COMPONENTS</b>				
TDSK-023	1	Anti Inversion Kit		Must be fitted with all leaf springs
TDUK-021/31	1	Urethane Shackle Bushing Kit		
TDUB-006	2	U-Bolt Kit		
TDGS-900	1	Greasable Shackle Kit		

### REPLACEMENT BUSHINGS

QUANTITY PER SHOCK				
TW959	2	Suits Top Front Pin		Pin Style Bushing
412772	1	Suits Bottom Front Eye		Eyering Bushing (#2057)
404702	2	Suits Top & Bottom Rear Eye		Eyering Bushing

Vehicle fitment sheet must be completed when suspension fitted. Failure to do so may affect warranty.  
Fitment sheet can be found on page 200 of this catalogue



# MITSUBISHI

TRITON

10/86-06

ME, MF, MG, MH, MK

## COMPLETE KIT PRICE REFERENCE

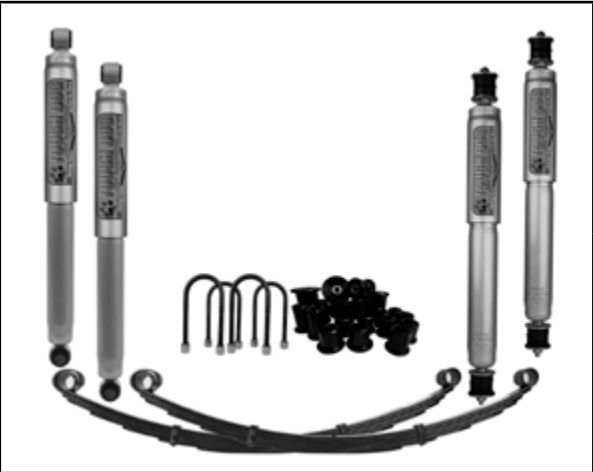
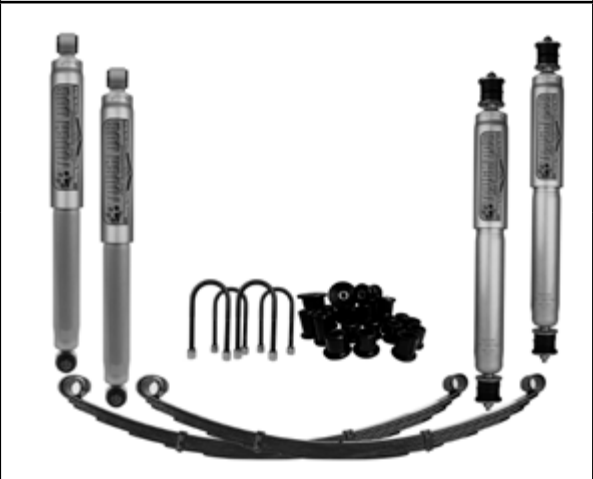
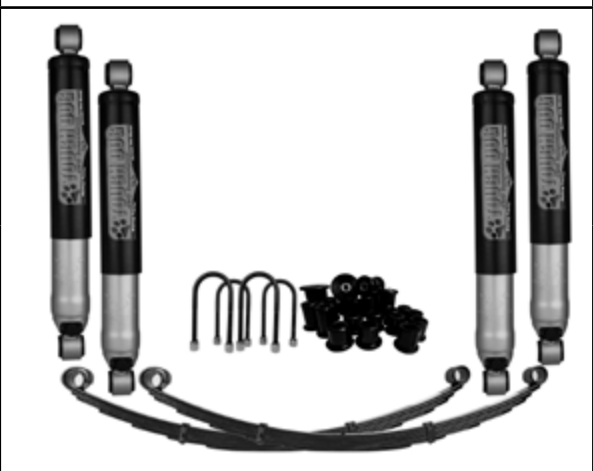
SHOCK CHOICE	SPRING CHOICE	RRP inc GST	CONTENTS
<p><b>35mm Nitro Gas</b></p> <p><u>Includes</u>                      2x Front Shocks                      2x Rear Shocks                      2x Leaf Springs                      1x Urethane Kit                      2x U-Bolt Kits                      1 X Anti Inversion Bkts</p>	<p>0-300KG Spring</p> <p><b>CONSTANT 300KG Spring</b></p>		
<p><b>41mm Foam Cell</b></p> <p><u>Includes</u>                      2x Front Shocks                      2x Rear Shocks                      2x Leaf Springs                      1x Urethane Kit                      2x U-Bolt Kits                      1 X Anti Inversion Bkts</p>	<p>0-300KG Spring</p> <p><b>CONSTANT 300KG Spring</b></p>		
<p><b>Foam Cell Front Adjustable Rear</b></p> <p><u>Includes</u>                      2x Front Shocks                      2x Rear Shocks                      2x Leaf Springs                      1x Urethane Kit                      2x U-Bolt Kits                      1 X Anti Inversion Bkts</p>	<p>0-300KG Spring</p> <p><b>CONSTANT 300KG Spring</b></p>		

Freight should be added where required. When determining spring choice, include only permanent accessories & weights. Towing requirements are not included in constant load determination

P: (02) 9672 8899 | F: (02) 9672 8099



# MITSUBISHI

## TRITON

7/06-15

ML MN (To MY15)



### FRONT SUSPENSION

**ESTIMATED LIFT: 25mm**

PART NO.	QTY	DESCRIPTION	RRP inc GST	NOTES
<b>SHOCK ABSORBERS</b>				
FC404800	2	40mm Foam Cell Strut		
BM404800	2	40mm Adjustable Strut		9 Stage Adjustable
<b>COIL SPRINGS</b>				
TDC670	2	25mm Lift Spring		Petrol/Diesel/Bar
TDC670H	2	25mm Lift Spring		Petrol/Diesel/Bar/Winch
<b>COMPLETE STRUT ASSEMBLY</b>				
MIT-060/01	2	BM404800/TDC670		Petrol/Diesel/Bar
MIT-060/02	2	BM404800/TDC670H		Petrol/Diesel/Bar/Winch
MIT-060/03	2	FC404800/TDC670		Petrol/Diesel/Bar
MIT-060/04	2	FC404800/TDC670H		Petrol/Diesel/Bar/Winch
<b>REPLACEMENT STRUT TOP</b>				
MIT-4040	2	Strut Top		Replacement Strut Top

### REAR SUSPENSION

<b>SHOCK ABSORBERS</b>				
BD1383T	2	35mm Nitro Gas Shocks		Suits Up to 25mm Lift
FC41383	2	41mm Foam Cell Shock		Suits Up to 25mm Lift
BM401383	2	40mm 9 Stage Adjustable		Suits Up to 25mm Lift
<b>LEAF SPRINGS</b>				
FS122C	2	0-300kg Load		25mm Lift
FS122L	2	<b>CONSTANT</b> 300Kg Load		25mm Lift
FS122LL	2	<b>CONSTANT</b> 500Kg Load		25mm Lift
<b>COMPONENTS</b>				
TDUK-021/41	1	Urethane Shackle Bushing Kit		Suits OEM Spring ONLY
TDUK-021/31	1	Urethane Shackle Bushing Kit		Suits Tough Dog Spring ONLY
TDUB-036	2	U-Bolt Kit		
TDGS-900	1	Greasable Shackle Kit		
<b>AIR ASSIST BAGS</b>				
TDAA-105	1	Bellows bag kit		Suits 25mm Lift

### REPLACEMENT BUSHINGS

QUANTITY PER SHOCK				
MIT-4040	1	Replacement Strut Top		Available As Complete Unit Only
ADJ00300/50	1	Suits Bottom Front Eying		Eying Bushing (FC and BM Pts)
402702	2	Suits Top & Bottom Rear Eying		Eying Bushing (Foam Cell)
TW038-16	1	Suits Top Rear Eying		Eying Bushing (Adjustable)
404702	1	Suits Bottom Rear Eying		Eying Bushing (Adjustable)

Vehicle fitment sheet must be completed when suspension fitted. Failure to do so may affect warranty.  
Fitment sheet can be found on page 200 of this catalogue

# MITSUBISHI

TRITON

7/06-15

ML MN (To MY15)

## COMPLETE KIT PRICE REFERENCE

SHOCK CHOICE	SPRING CHOICE	RRP inc GST	CONTENTS
<p><b>Foam Cell Struts Require Assembly</b></p> <p><b>Includes</b></p> <p>2x Front Struts 2x Rear Shocks 2x Front Coils 2x Leaf Springs 1x Urethane Kit 2x U-Bolt Kits</p>	<p><b>FS122C</b> (Foam Front Gas Rear)</p> <p><b>FS122C</b> (Foam Cell All)</p> <p><b>FS122L</b> <b>CONSTANT 300KG</b></p> <p><b>FS122LL</b> <b>CONSTANT 500KG</b></p>		
<p><b>Foam Cell Complete Assembly Struts</b></p> <p><b>Includes</b></p> <p>2x Front Strut Assy 2x Rear Shocks 2x Leaf Springs 1x Urethane Kit 2x U-Bolt Kits</p>	<p><b>FS122C</b> (Foam Front Gas Rear)</p> <p><b>FS122C</b> (Foam Cell All)</p> <p><b>FS122L</b> <b>CONSTANT 300KG</b></p> <p><b>FS122LL</b> <b>CONSTANT 500KG</b></p>		
<p><b>40mm Adjustable Struts Require Assembly</b></p> <p><b>Includes</b></p> <p>2x Front Struts 2x Rear Shocks 2x Front Coils 2x Leaf Springs 1x Urethane Kit 2x U-Bolt Kits</p>	<p><b>FS122C</b> 0-300KG</p> <p><b>FS122L</b> <b>CONSTANT 300KG</b></p> <p><b>FS122LL</b> <b>CONSTANT 500KG</b></p>		
<p><b>40mm Adjustable Complete Assembly Struts</b></p> <p><b>Includes</b></p> <p>2x Front Strut Assy 2x Rear Shocks 2x Leaf Springs 1x Urethane Kit 2x U-Bolt Kits</p>	<p><b>FS122C</b> 0-300KG</p> <p><b>FS122L</b> <b>CONSTANT 300KG</b></p> <p><b>FS122LL</b> <b>CONSTANT 500KG</b></p>		

Freight should be added where required. When determining spring choice, include only permanent accessories & weights. Towing requirements are not included in constant load determination

# MITSUBISHI

## TRITON

01/15 On

MQ (From MY16)



### FRONT SUSPENSION

**ESTIMATED LIFT: 20mm**

PART NO.	QTY	DESCRIPTION	RRP inc GST	NOTES
<b>SHOCK ABSORBERS</b>				
FC404800	2	40mm Foam Cell Strut		
BM404800	2	40mm Adjustable Strut		9 Stage Adjustable
<b>COIL SPRINGS</b>				
TDC681	2	20mm Lift Spring		Diesel
TDC681L	2	20mm Lift Spring		Diesel/Bar
TDC681HL	2	20mm Lift Spring		Diesel/Bar/Winch
<b>COMPLETE STRUT ASSEMBLY</b>				
MIT-061/01	2	BM404800/TDC681		Diesel
MIT-061/02	2	BM404800/TDC681L		Diesel/Bar
MIT-061/03	2	BM404800/TDC681HL		Diesel/Bar/Winch
MIT-061/05	2	FC404800/TDC681		Diesel
MIT-061/06	2	FC404800/TDC681L		Diesel/Bar
MIT-061/07	2	FC404800/TDC681HL		Diesel/Bar/Winch
<b>REPLACEMENT STRUT TOP</b>				
MIT-4040	2	Strut Top		Replacement Strut Top

### REAR SUSPENSION

<b>SHOCK ABSORBERS</b>				
BD3012T	2	35mm Nitro Gas Shocks		Suits Up to 20mm Lift
FC43012	2	41mm Foam Cell Shock		Suits Up to 20mm Lift
BM403012	2	40mm 9 Stage Adjustable		Suits Up to 20mm Lift
<b>LEAF SPRINGS</b>				
FS123C	2	0-300kg Load		20mm Lift
FS123L	2	<b>CONSTANT</b> 300Kg Load		20mm Lift
FS123LL	2	<b>CONSTANT</b> 500Kg Load		20mm Lift
<b>COMPONENTS</b>				
TDUK-077	1	Urethane Shackle Bushing Kit		
TDUB-016	2	U-Bolt Kit		
TDGS-901	1	Greasable Shackle Kit		
TDGP-668	1	Greasable Pin Kit		
TDSP-008	1	Centre Bearing Strengthening Kit		Required with all Lift Kits
<b>AIR ASSIST BAGS</b>				
TDAA-106	1	Bellows bag kit		Suits 20mm Lift

### REPLACEMENT BUSHINGS

QUANTITY PER SHOCK				
MIT-4040	1	Replacement Strut Top		Available As Complete Unit Only
ADJ00300/50	1	Suits Bottom Front Eying		Eying Bonded Bushing
404702	1	Suits Top Rear Eying		Eying Bushing
TW038-16	1	Suits Bottom Rear Eying		Eying Bushing

Vehicle fitment sheet must be completed when suspension fitted. Failure to do so may affect warranty.

Fitment sheet can be found on page 200 of this catalogue

Note: Centre bearing strengthening kit fitting instructions available at [toughdog.com.au](http://toughdog.com.au)





# MITSUBISHI

## TRITON

01/15 On

MQ (From MY16)

### COMPLETE KIT PRICE REFERENCE

SHOCK CHOICE	SPRING CHOICE	RRP inc GST	CONTENTS
<p><b>Foam Cell Struts Require Assembly</b></p> <p><u>Includes</u>            2x Front Struts            2x Rear Shocks            2x Front Coils            2x Leaf Springs            1x Urethane Kit            2x U-Bolt Kits            1x Centre Bearing Kit</p>	<p><b>FS123C</b> (Foam Front Gas Rear)</p> <p><b>FS123C</b> (Foam Cell All)</p> <p><b>FS123L</b> CONSTANT 300KG</p> <p><b>FS123LL</b> CONSTANT 500KG</p>		
<p><b>Foam Cell Complete Assembly Struts</b></p> <p><u>Includes</u>            2x Complete Struts            2x Rear Shocks            2x Leaf Springs            1x Urethane Kit            2x U-Bolt Kits            1x Centre Bearing Kit</p>	<p><b>FS123C</b> (Foam Front Gas Rear)</p> <p><b>FS123C</b> (Foam Cell All)</p> <p><b>FS123L</b> CONSTANT 300KG</p> <p><b>FS123LL</b> CONSTANT 500KG</p>		
<p><b>40mm Adjustable Struts Require Assembly</b></p> <p><u>Includes</u>            2x Front Struts            2x Rear Shocks            2x Front Coils            2x Leaf Springs            1x Urethane Kit            2x U-Bolt Kits            1x Centre Bearing Kit</p>	<p><b>FS123C</b> 0-300KG</p> <p><b>FS123L</b> CONSTANT 300KG</p> <p><b>FS123LL</b> CONSTANT 500KG</p>		
<p><b>40mm Adjustable Complete Assembly Struts</b></p> <p><u>Includes</u>            2x Complete Struts            2x Rear Shocks            2x Leaf Springs            1x Urethane Kit            2x U-Bolt Kits            1x Centre Bearing Kit</p>	<p><b>FS123C</b> 0-300KG</p> <p><b>FS123L</b> CONSTANT 300KG</p> <p><b>FS123LL</b> CONSTANT 500KG</p>		

Freight should be added where required. When determining spring choice, include only permanent accessories & weights. Towing requirements are not included in constant load determination

P: (02) 9672 8899 | F: (02) 9672 8099



# NISSAN

## NAVARA

1/86-15

D21, D22



### FRONT SUSPENSION

**ESTIMATED LIFT: 40mm**

PART NO.	QTY	DESCRIPTION	RRP inc GST	NOTES
<b>SHOCK ABSORBERS</b>				
FC42052B	2	35mm Foam Cell Shock		Up to 40mm Lift
<b>TORSION BARS</b>				
4WTB-1456	1	Replacement Torsion Bars		26mm/1203mm '1/86-97 ONLY
4WTB-1446	1	Replacement Torsion Bars		26mm/890mm '97 On ONLY
<b>Adjust Torsion bars after fitting shocks - Ensure a minimum of 60mm Droop is Maintained</b>				
<b>STEERING DAMPERS</b>				
SD14035	1	H/D Replacement Damper		Suits D21 Vehicles Only
EXT5925	1	H/D Replacement Damper		Suits D22 Vehicles Only
SS5925-P/S	1	Return to Centre Damper		Fitting instructions found at toughdog.com.au
SV5925	1	9 Stage Adjustable Damper		

### REAR SUSPENSION

<b>SHOCK ABSORBERS</b>				
BD1366T	2	35mm Nitro Gas Shock		
FC41366B	2	41mm Foam Cell Shock		Suits OE Height
BM401366	2	40mm 9 Stage Adjustable		
BD1382T	2	35mm Nitro Gas Shock		
FC41382B	2	41mm Foam Cell Shock		Suits 40mm Lift
BM401382	2	40mm 9 Stage Adjustable		
<b>LEAF SPRINGS</b>				
T63	2	0-300kg Load		40mm Lift
T63H	2	<b>CONSTANT</b> 300Kg Load		40mm Lift
<b>COMPONENTS</b>				
TDUK-007	1	Urethane Shackle Bushing Kit		
TDUB-012	2	U-Bolt Kit		
TDGS-668	1	Greasable Shackle Kit		
TDGP-669	1	Greasable Pin Kit		
<b>AIR ASSIST BAGS</b>				
TDAA-107	1	Bellows bag kit		Suits 40mm Lift

### REPLACEMENT BUSHINGS

QUANTITY PER SHOCK				
TW959	2	Suits Front Top Pin		Pin Style Bushing
404702	2	Suits Top & Bottom Rear Eye		Eyering Bushing
412773	1	Suits Front Bottom Eye		



Vehicle fitment sheet must be completed when suspension fitted. Failure to do so may affect warranty.  
Fitment sheet can be found on page 200 of this catalogue

# NISSAN

## NAVARA

1/86-15  
D21, D22

### COMPLETE KIT PRICE REFERENCE

SHOCK CHOICE	SPRING CHOICE	RRP inc GST	CONTENTS
<p><b>Foam Cell Front Nitro Gas Rear</b></p> <p><u>Includes</u> 2x Front Shocks 2x Rear Shocks 2x Leaf Springs 1x Urethane Kit 2x U-Bolt Kits</p>	<p><b>T63 0-300KG Spring</b></p> <p><b>T63H CONSTANT 300KG Spring</b></p>		
<p><b>41mm Foam Cell</b></p> <p><u>Includes</u> 2x Front Shocks 2x Rear Shocks 2x Leaf Springs 1x Urethane Kit 2x U-Bolt Kits</p>	<p><b>T63 0-300KG Spring</b></p> <p><b>T63H CONSTANT 300KG Spring</b></p>		
<p><b>Foam Cell Front Adjustable Rear</b></p> <p><u>Includes</u> 2x Front Shocks 2x Rear Shocks 2x Leaf Springs 1x Urethane Kit 2x U-Bolt Kits</p>	<p><b>T63 0-300KG Spring</b></p> <p><b>T63H CONSTANT 300KG Spring</b></p>		

Freight should be added where required. When determining spring choice, include only permanent accessories & weights. Towing requirements are not included in constant load determination

# NISSAN

## NAVARA

12/05-15

D40 - 2.5L, 4.0L



### FRONT SUSPENSION

**ESTIMATED LIFT: 40mm**

PART NO.	QTY	DESCRIPTION	RRP inc GST	NOTES
<b>SHOCK ABSORBERS</b>				
FC404700	2	40mm Foam Cell Strut		
BM404700	2	40mm Adjustable Strut		9 Stage Adjustable
<b>COIL SPRINGS</b>				
TDC770	2	40mm Lift Spring		Petrol/Diesel/Bar
TDC770H	2	40mm Lift Spring		Petrol/Diesel/Bar/Winch
<b>COMPLETE STRUT ASSEMBLY</b>				
NIS-040/01	2	BM404700/TDC770		Petrol/Diesel/Bar
NIS-040/02	2	BM404700/TDC770H		Petrol/Diesel/Bar/Winch
NIS-040/04	2	FC404700/TDC770		Petrol/Diesel/Bar
NIS-040/05	2	FC404700/TDC770H		Petrol/Diesel/Bar/Winch
<b>REPLACEMENT STRUT TOP</b>				
NIS-3030	2	Strut Top		Replacement Strut Top

### REAR SUSPENSION

<b>SHOCK ABSORBERS</b>				
BD1368T	2	35mm Nitro Gas Shock		Up to 40mm Lift (Comfort Use)
FC41368	2	41mm Foam Cell Shock		Up to 40mm Lift
BM401368	2	40mm 9 Stage Adjustable		Up to 40mm Lift
<b>LEAF SPRINGS</b>				
T85C	2	0-300kg Load		40mm Lift
T85L	2	<b>CONSTANT</b> 300Kg Load		40mm Lift
T85LL	2	<b>CONSTANT</b> 500Kg Load		40mm Lift
<b>COMPONENTS</b>				
TDUK-068	1	Urethane Shackle Bushing Kit		
TDUB-016	2	U-Bolt Kit		
TDGS-667	1	Greasable Shackle Kit		
TDGP-668	1	Greasable Pin Kit		
<b>AIR ASSIST BAGS</b>				
TDAA-108	1	Bellows bag kit		Suits 40mm Lift

### REPLACEMENT BUSHINGS

QUANTITY PER SHOCK				
NIS-3030	1	Replacement Strut Top		Available As Complete Unit Only
ADJ00300/40	1	Suits Bottom Front Eying		Eying Bonded Bushing
404702	1	Suits Rear Top Eying		Eying Bushing
TW040-14	1	Suits Rear Bottom Eying		Eying Bushing

Vehicle fitment sheet must be completed when suspension fitted. Failure to do so may affect warranty.  
Fitment sheet can be found on page 200 of this catalogue







**Note: Urethane Bushing kit fitting instructions available at [toughdog.com.au](http://toughdog.com.au)**

# NISSAN

## NAVARA

12/05-15  
D40 - 2.5L, 4.0L

### COMPLETE KIT PRICE REFERENCE

SHOCK CHOICE	SPRING CHOICE	RRP inc GST	CONTENTS
<p><b>Foam Cell Struts Require Assembly</b></p> <p><b>Includes</b></p> <ul style="list-style-type: none"> <li>2x Front Struts</li> <li>2x Rear Shocks</li> <li>2x Front Coils</li> <li>2x Leaf Springs</li> <li>1x Urethane Kit</li> <li>2x U-Bolt Kits</li> </ul>	<p><b>T85C</b> (Foam Front Gas Rear)</p> <p><b>T85C</b> (Foam Cell All)</p> <p><b>T85L</b> CONSTANT 300KG</p> <p><b>T85LL</b> CONSTANT 500KG</p>		
<p><b>Foam Cell Complete Assembly Struts</b></p> <p><b>Includes</b></p> <ul style="list-style-type: none"> <li>2x Complete Struts</li> <li>2x Rear Shocks</li> <li>2x Leaf Springs</li> <li>1x Urethane Kit</li> <li>2x U-Bolt Kits</li> </ul>	<p><b>T85C</b> (Foam Front Gas Rear)</p> <p><b>T85C</b> (Foam Cell All)</p> <p><b>T85L</b> CONSTANT 300KG</p> <p><b>T85LL</b> CONSTANT 500KG</p>		
<p><b>40mm Adjustable Struts Require Assembly</b></p> <p><b>Includes</b></p> <ul style="list-style-type: none"> <li>2x Front Struts</li> <li>2x Rear Shocks</li> <li>2x Front Coils</li> <li>2x Leaf Springs</li> <li>1x Urethane Kit</li> <li>2x U-Bolt Kits</li> </ul>	<p><b>T85C</b> 0-300KG</p> <p><b>T85L</b> CONSTANT 300KG</p> <p><b>T85LL</b> CONSTANT 500KG</p>		
<p><b>40mm Adjustable Complete Assembly Struts</b></p> <p><b>Includes</b></p> <ul style="list-style-type: none"> <li>2x Complete Struts</li> <li>2x Rear Shocks</li> <li>2x Leaf Springs</li> <li>1x Urethane Kit</li> <li>2x U-Bolt Kits</li> </ul>	<p><b>T85C</b> 0-300KG</p> <p><b>T85L</b> CONSTANT 300KG</p> <p><b>T85LL</b> CONSTANT 500KG</p>		

Freight should be added where required. When determining spring choice, include only permanent accessories & weights. Towing requirements are not included in constant load determination

# NISSAN

## NAVARA

11-15

D40 - 3.0L STX-550 V6



### FRONT SUSPENSION

**ESTIMATED LIFT: 40mm**

PART NO.	QTY	DESCRIPTION	RRP inc GST	NOTES
<b>SHOCK ABSORBERS</b>				
FC404700	2	40mm Foam Cell Strut		
BM404700	2	40mm Adjustable Strut		9 Stage Adjustable
<b>COIL SPRINGS</b>				
TDC772	2	40mm Lift Spring		Petrol/Diesel/Bar
TDC772H	2	40mm Lift Spring		Petrol/Diesel/Bar/Winch
<b>COMPLETE STRUT ASSEMBLY</b>				
NIS-040/06	2	BM404700/TDC772		Petrol/Diesel/Bar
NIS-040/03	2	BM404700/TDC772H		Petrol/Diesel/Bar/Winch
NIS-040/07	2	FC404700/TDC772		Petrol/Diesel/Bar
NIS-040/08	2	FC404700/TDC772H		Petrol/Diesel/Bar/Winch
<b>REPLACEMENT STRUT TOP</b>				
NIS-3030	2	Strut Top		Replacement Strut Top

### REAR SUSPENSION

<b>SHOCK ABSORBERS</b>				
BD1368T	2	35mm Nitro Gas Shock		Up to 40mm Lift (Comfort Use)
FC41368	2	41mm Foam Cell Shock		Up to 40mm Lift
BM401368	2	40mm 9 Stage Adjustable		Up to 40mm Lift
<b>LEAF SPRINGS</b>				
T85C	2	0-300kg Load		40mm Lift
T85L	2	<b>CONSTANT</b> 300Kg Load		40mm Lift
T85LL	2	<b>CONSTANT</b> 500Kg Load		40mm Lift
<b>COMPONENTS</b>				
TDUK-068	1	Urethane Shackle Bushing Kit		
TDUB-016	2	U-Bolt Kit		
TDGS-667	1	Greasable Shackle Kit		
TDGP-668	1	Greasable Pin Kit		
<b>AIR ASSIST BAGS</b>				
TDAA-108	1	Bellows bag kit		Suits 40mm Lift

### REPLACEMENT BUSHINGS

QUANTITY PER SHOCK				
NIS-3030	1	Replacement Strut Top		Available As Complete Unit Only
ADJ00300/40	1	Suits Bottom Front Eying		Eying Bonded Bushing
404702	1	Suits Rear Top Eying		Eying Bushing
TW040-14	1	Suits Rear Bottom Eying		Eying Bushing

Vehicle fitment sheet must be completed when suspension fitted. Failure to do so may affect warranty.  
Fitment sheet can be found on page 200 of this catalogue

Note: Urethane Bushing kit fitting instructions available at [toughdog.com.au](http://toughdog.com.au)

# NISSAN

## NAVARA

11-15

D40 - 3.0L STX-550 V6

### COMPLETE KIT PRICE REFERENCE

SHOCK CHOICE	SPRING CHOICE	RRP inc GST	CONTENTS
<p><b>Foam Cell Struts Require Assembly</b></p> <p><b>Includes</b></p> <ul style="list-style-type: none"> <li>2x Front Struts</li> <li>2x Rear Shocks</li> <li>2x Front Coils</li> <li>2x Leaf Springs</li> <li>1x Urethane Kit</li> <li>2x U-Bolt Kits</li> </ul>	<p><b>T85C</b> (Foam Front Gas Rear)</p> <p><b>T85C</b> (Foam Cell All)</p> <p><b>T85L</b> CONSTANT 300KG</p> <p><b>T85LL</b> CONSTANT 500KG</p>		
<p><b>Foam Cell Complete Assembly Struts</b></p> <p><b>Includes</b></p> <ul style="list-style-type: none"> <li>2x Complete Struts</li> <li>2x Rear Shocks</li> <li>2x Leaf Springs</li> <li>1x Urethane Kit</li> <li>2x U-Bolt Kits</li> </ul>	<p><b>T85C</b> (Foam Front Gas Rear)</p> <p><b>T85C</b> (Foam Cell All)</p> <p><b>T85L</b> CONSTANT 300KG</p> <p><b>T85LL</b> CONSTANT 500KG</p>		
<p><b>40mm Adjustable Struts Require Assembly</b></p> <p><b>Includes</b></p> <ul style="list-style-type: none"> <li>2x Front Struts</li> <li>2x Rear Shocks</li> <li>2x Front Coils</li> <li>2x Leaf Springs</li> <li>1x Urethane Kit</li> <li>2x U-Bolt Kits</li> </ul>	<p><b>T85C</b> 0-300KG</p> <p><b>T85L</b> CONSTANT 300KG</p> <p><b>T85LL</b> CONSTANT 500KG</p>		
<p><b>40mm Adjustable Complete Assembly Struts</b></p> <p><b>Includes</b></p> <ul style="list-style-type: none"> <li>2x Complete Struts</li> <li>2x Rear Shocks</li> <li>2x Leaf Springs</li> <li>1x Urethane Kit</li> <li>2x U-Bolt Kits</li> </ul>	<p><b>T85C</b> 0-300KG</p> <p><b>T85L</b> CONSTANT 300KG</p> <p><b>T85LL</b> CONSTANT 500KG</p>		

Freight should be added where required. When determining spring choice, include only permanent accessories & weights. Towing requirements are not included in constant load determination

# NISSAN

## NAVARA

7/15 On

NP300 - Coil Rear Only



### FRONT SUSPENSION

**ESTIMATED LIFT: 35mm**

PART NO.	QTY	DESCRIPTION	RRP inc GST	NOTES
<b>SHOCK ABSORBERS</b>				
FC404710	2	40mm Foam Cell Strut		
BM404710	2	40mm Adjustable Strut		9 Stage Adjustable
<b>COIL SPRINGS</b>				
TDC773	2	35mm Lift Spring		Petrol/Diesel/Bar
TDC773H	2	35mm Lift Spring		Petrol/Diesel/Bar/Winch
<b>COMPLETE STRUT ASSEMBLY</b>				
NIS-300/05	2	BM404710/TDC773		Petrol/Diesel/Bar
NIS-300/06	2	BM404710/TDC773H		Petrol/Diesel/Bar/Winch
NIS-300/07	2	FC404710/TDC773		Petrol/Diesel/Bar
NIS-300/08	2	FC404710/TDC773H		Petrol/Diesel/Bar/Winch
<b>REPLACEMENT STRUT TOP</b>				
NIS-3030	2	Strut Top		Replacement Strut Top

### REAR SUSPENSION

<b>SHOCK ABSORBERS</b>				
FC41369	2	41mm Foam Cell Shock		Up to 35mm Lift
BM401369	2	40mm 9 Stage Adjustable		Up to 35mm Lift
<b>COIL SPRINGS</b>				
TDC774	2	0-300kg Load		35mm Lift
TDC774H	2	<b>CONSTANT</b> 300Kg Load		35mm Lift
TDC774VHL	2	<b>CONSTANT</b> 500Kg Load		35mm Lift
<b>COMPONENTS</b>				
TDPR-300	1	Adjustable Panhard Rod		
<b>AIR ASSIST BAGS</b>				
TDAA-007	1	Coil insert bag kit		Suits 35mm Lift

### REPLACEMENT BUSHINGS

QUANTITY PER SHOCK				
NIS-3030	1	Replacement Strut Top		Available As Complete Unit Only
ADJ00300/40	1	Suits Bottom Front Eying		Eying Bonded Bushing
TW038-16	1	Suits Rear Top Eying		Eying Bushing
TW040-14	1	Suits Rear Bottom Eying		Eying Bushing

Vehicle fitment sheet must be completed when suspension fitted. Failure to do so may affect warranty.

Fitment sheet can be found on page 200 of this catalogue





# NISSAN

## NAVARA

7/15 On

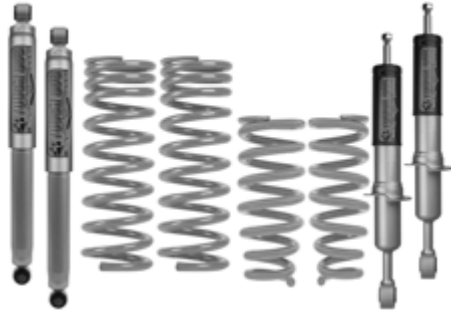
NP300 - Coil Rear Only

### COMPLETE KIT PRICE REFERENCE

SHOCK CHOICE	SPRING CHOICE	RRP inc GST	CONTENTS
<p><b>Foam Cell Struts Require Assembly</b></p> <p><u>Includes</u> 2x Front Struts 2x Rear Shocks 2x Front Coils 2x Rear Coils</p>	<p>TDC774 0-300KG Spring</p> <p>TDC774H CONSTANT 300KG Spring</p> <p>TDC774VHL CONSTANT 500KG Spring</p>		
<p><b>Foam Cell Complete Assembly Struts</b></p> <p><u>Includes</u> 2x Front Strut Assembly 2x Rear Shocks 2x Rear Coils</p>	<p>TDC774 0-300KG Spring</p> <p>TDC774H CONSTANT 300KG Spring</p> <p>TDC774VHL CONSTANT 500KG Spring</p>		
<p><b>40mm Adjustable Struts Require Assembly</b></p> <p><u>Includes</u> 2x Front Struts 2x Rear Shocks 2x Front Coils 2x Rear Coils</p>	<p>TDC774 0-300KG Spring</p> <p>TDC774H CONSTANT 300KG Spring</p> <p>TDC774VHL CONSTANT 500KG Spring</p>		
<p><b>40mm Adjustable Complete Assembly Struts</b></p> <p><u>Includes</u> 2x Front Strut Assembly 2x Rear Shocks 2x Rear Coils</p>	<p>TDC774 0-300KG Spring</p> <p>TDC774H CONSTANT 300KG Spring</p> <p>TDC774VHL CONSTANT 500KG Spring</p>		

Freight should be added where required. When determining spring choice, include only permanent accessories & weights. Towing requirements are not included in constant load determination

# NISSAN

## NAVARA

7/15 on

NP300 - Leaf rear only



### FRONT SUSPENSION

**ESTIMATED LIFT: 35mm**

PART NO.	QTY	DESCRIPTION	RRP inc GST	NOTES
<b>SHOCK ABSORBERS</b>				
FC404710	2	40mm Foam Cell Strut		
BM404710	2	40mm Adjustable Strut		9 Stage Adjustable
<b>COIL SPRINGS</b>				
TDC773	2	35mm Lift Spring		Petrol/Diesel/Bar
TDC773H	2	35mm Lift Spring		Petrol/Diesel/Bar/Winch
<b>COMPLETE STRUT ASSEMBLY</b>				
NIS-300/05	2	BM404710/TDC773		Petrol/Diesel/Bar
NIS-300/06	2	BM404710/TDC773H		Petrol/Diesel/Bar/Winch
NIS-300/07	2	FC404710/TDC773		Petrol/Diesel/Bar
NIS-300/08	2	FC404710/TDC773H		Petrol/Diesel/Bar/Winch
<b>REPLACEMENT STRUT TOP</b>				
NIS-3030	2	Strut Top		Replacement Strut Top

### REAR SUSPENSION

<b>SHOCK ABSORBERS</b>				
FC43017	2	41mm Foam Cell Shock		Up to 35mm Lift
BM403017	2	40mm 9 Stage Adjustable		Up to 35mm Lift
<b>LEAF SPRINGS</b>				
T86C	2	0-300kg Load		35mm Lift
T86L	2	<b>CONSTANT</b> 300Kg Load		35mm Lift
T86LL	2	<b>CONSTANT</b> 500Kg Load		35mm Lift
<b>COMPONENTS</b>				
TDUK-079	1	Urethane Shackle Bushing Kit		
TDUB-005	2	U-Bolt Kit		
TDGS-669	1	Greasable Shackle Kit		
TDGP-668	1	Greasable Pin Kit		
<b>AIR ASSIST BAGS</b>				
TDAA-109	1	Bellows bag kit		Suits 35mm Lift

### REPLACEMENT BUSHINGS

QUANTITY PER SHOCK				
NIS-3030	1	Replacement Strut Top		Available As Complete Unit Only
ADJ00300/40	1	Suits Bottom Front Eying		Eying Bonded Bushing
404702	1	Suits Rear Top Eying		Eying Bushing
404702	1	Suits Rear Bottom Eying		Eying Bushing

Vehicle fitment sheet must be completed when suspension fitted. Failure to do so may affect warranty.

Fitment sheet can be found on page 200 of this catalogue

**Note: Urethane Bushing kit fitting instructions available at [toughdog.com.au](http://toughdog.com.au)**

# NISSAN

## NAVARA

7/15 on  
NP300 - Leaf rear only

### COMPLETE KIT PRICE REFERENCE

SHOCK CHOICE	SPRING CHOICE	RRP inc GST	CONTENTS
<p><b>Foam Cell Struts Require Assembly</b></p> <p><b>Includes</b></p> <ul style="list-style-type: none"> <li>2x Front Struts</li> <li>2x Rear Shocks</li> <li>2x Front Coils</li> <li>2x Leaf Springs</li> <li>1x Urethane Kit</li> <li>2x U-Bolt Kits</li> </ul>	<p>T86C</p> <p>T86L CONSTANT 300KG</p> <p>T86LL CONSTANT 500KG</p>		
<p><b>Foam Cell Complete Assembly Struts</b></p> <p><b>Includes</b></p> <ul style="list-style-type: none"> <li>2x Complete Struts</li> <li>2x Rear Shocks</li> <li>2x Leaf Springs</li> <li>1x Urethane Kit</li> <li>2x U-Bolt Kits</li> </ul>	<p>T86C</p> <p>T86L CONSTANT 300KG</p> <p>T86LL CONSTANT 500KG</p>		
<p><b>40mm Adjustable Struts Require Assembly</b></p> <p><b>Includes</b></p> <ul style="list-style-type: none"> <li>2x Front Struts</li> <li>2x Rear Shocks</li> <li>2x Front Coils</li> <li>2x Leaf Springs</li> <li>1x Urethane Kit</li> <li>2x U-Bolt Kits</li> </ul>	<p>T86C 0-300KG</p> <p>T86L CONSTANT 300KG</p> <p>T86LL CONSTANT 500KG</p>		
<p><b>40mm Adjustable Complete Assembly Struts</b></p> <p><b>Includes</b></p> <ul style="list-style-type: none"> <li>2x Complete Struts</li> <li>2x Rear Shocks</li> <li>2x Leaf Springs</li> <li>1x Urethane Kit</li> <li>2x U-Bolt Kits</li> </ul>	<p>T86C 0-300KG</p> <p>T86L CONSTANT 300KG</p> <p>T86LL CONSTANT 500KG</p>		

Freight should be added where required. When determining spring choice, include only permanent accessories & weights. Towing requirements are not included in constant load determination

# NISSAN

## PATHFINDER

12/86-95

WNYD21, WHYD21



### FRONT SUSPENSION

**ESTIMATED LIFT: 30mm**

PART NO.	QTY	DESCRIPTION	RRP inc GST	NOTES
<b>SHOCK ABSORBERS</b>				
BD2057T	2	35mm Nitro Gas Shock		Up to 30mm Lift
FC42057B	2	41mm Foam Cell Shock		Up to 30mm Lift
<b>TORSION BARS</b>				
4WTB-1458	1	Replacement Torsion Bars		26mm/1232mm
<b>Adjust Torsion bars after fitting shocks - Ensure a minimum of 60mm Droop is Maintained</b>				
<b>STEERING DAMPERS</b>				
SD14035	1	H/D Replacement Damper		Suits D21 Vehicles Only

### REAR SUSPENSION

<b>SHOCK ABSORBERS</b>				
BD1382T	2	35mm Nitro Gas Shock		Up to 30mm Lift
FC41382B	2	41mm Foam Cell Shock		Up to 30mm Lift
BM401382	2	40mm 9 Stage Adjustable		Up to 30mm Lift
<b>COIL SPRINGS</b>				
TDC739S	2	0-300kg Load		OE Height
TDC739	2	0-300kg Load		30mm Lift
TDC739H	2	<b>CONSTANT</b> 300Kg Load		30mm Lift

### REPLACEMENT BUSHINGS

QUANTITY PER SHOCK				
TW959	2	Suits Top Front Pin Mount		Pin Style Bushing
404702	2	Suits Rear Top & Bottom Eying		Eying Bushing
412772	1	Suits Bottom Front Eying		Eying Bushing

### COMPLETE KIT PRICE REFERENCE

SHOCK CHOICE	SPRING CHOICE	RRP inc GST	CONTENTS
35mm Nitro gas	ANY		
41mm Foam Cell	ANY		
Foam Cell Front Adjustable Rear	ANY		
<b>Includes</b> 2 x Coil Springs    4 x Shocks			

Vehicle fitment sheet must be completed when suspension fitted. Failure to do so may affect warranty.  
Fitment sheet can be found on page 200 of this catalogue





# NISSAN

## PATHFINDER R50

11/95-99 & 2/99-05  
R50 (Series I, II, III)

### FRONT SUSPENSION

**ESTIMATED LIFT: 30mm**

PART NO.	QTY	DESCRIPTION	RRP inc GST	NOTES
<b>SHOCK ABSORBERS</b>				
BDS4002 (D/S)	1	Twin Tube McPherson Strut		OE Height Suit 11/95-99 ONLY
BDS4003 (P/S)	1	Twin Tube McPherson Strut		OE Height Suit 11/95-99 ONLY
BDS4024	2	Twin Tube McPherson Strut		Suits up to 30mm (all models)
<b>COIL SPRINGS</b>				
TDC784S	2	OE Height Lift Spring		OE Height only
TDC784	2	30mm Lift Spring		Suits up to Steel Bar
TDC784H	2	30mm Lift Spring		Suits Bar & Winch

### REAR SUSPENSION

<b>SHOCK ABSORBERS</b>				
BD3009T	2	35mm Nitro Gas Shock		OE Height Suit 11/95-99 ONLY
FC43009	2	41mm Foam Cell Shock		OE Height Suit 11/95-99 ONLY
BD3010T	2	35mm Nitro Gas Shock		30mm Lift Suit 11/95-99 ONLY
FC43010	2	41mm Foam Cell Shock		30mm Lift Suit 11/95-99 ONLY
BD3011T	2	35mm Nitro Gas Shock		OE & 30mm 11/99-05 ONLY
FC43011	2	41mm Foam Cell Shock		OE & 30mm 11/99-05 ONLY
<b>COIL SPRINGS</b>				
TDC783S	2	0-300kg Load		OE Height
TDC783	2	0-300kg Load		30mm Lift
TDC783H	2	<b>CONSTANT</b> 300Kg Load		30mm Lift

### COMPLETE KIT PRICE REFERENCE

SHOCK CHOICE	SPRING CHOICE	RRP inc GST	CONTENTS
35mm Nitrogen Gas	30mm Lift		
	OE Height (95-99)		
Nitrogen Gas Front Foam Cell Rear	30mm Lift		
	OE Height (99-05)		
<p align="center"><b>Includes</b></p> <p align="center">2 x Struts      4 x Coil Springs 2 x Rear Shocks</p>			

Freight should be added where required. When determining spring choice, include only permanent accessories & weights. Towing requirements are not included in constant load determination

# NISSAN

## PATHFINDER

11/05-15

R51 - 2.5L, 4.0L



### FRONT SUSPENSION

**ESTIMATED LIFT: 40mm**

PART NO.	QTY	DESCRIPTION	RRP inc GST	NOTES
<b>SHOCK ABSORBERS</b>				
FC404700	2	40mm Foam Cell Strut		
BM404700	2	40mm Adjustable Strut		9 Stage Adjustable
<b>COIL SPRINGS</b>				
TDC770	2	40mm Lift Spring		Petrol/Diesel/Bar
TDC770H	2	40mm Lift Spring		Petrol/Diesel/Bar/Winch
<b>COMPLETE STRUT ASSEMBLY</b>				
NIS-040/01	2	BM404700/TDC770		Petrol/Diesel/Bar
NIS-040/02	2	BM404700/TDC770H		Petrol/Diesel/Bar/Winch
NIS-040/04	2	FC404700/TDC770		Petrol/Diesel/Bar
NIS-040/05	2	FC404700/TDC770H		Petrol/Diesel/Bar/Winch
<b>REPLACEMENT STRUT TOP</b>				
NIS-3030	2	Strut Top		Replacement Strut Top

### REAR SUSPENSION

<b>SHOCK ABSORBERS</b>				
FC41347	2	41mm Foam Cell Shock		Up to 40mm Lift
BM401347	2	40mm 9 Stage Adjustable		Up to 40mm Lift
<b>COIL SPRINGS</b>				
TDC771	2	0-300kg Load		40mm Lift
TDC771H	2	<b>CONSTANT</b> 300Kg Load		40mm Lift
TDC771XHD	2	<b>CONSTANT</b> 500Kg Load		40mm Lift
<b>AIR ASSIST BAGS</b>				
TDAA-002	1	Coil insert bag kit		Suits 40mm Lift

### REPLACEMENT BUSHINGS

QUANTITY PER SHOCK				
NIS-3030	1	Replacement Strut Top		Available As Complete Unit Only
ADJ00300/40	1	Suits Bottom Front Eying		Eying Bonded Bushing





Vehicle fitment sheet must be completed when suspension fitted. Failure to do so may affect warranty.  
Fitment sheet can be found on page 200 of this catalogue

# NISSAN

## PATHFINDER

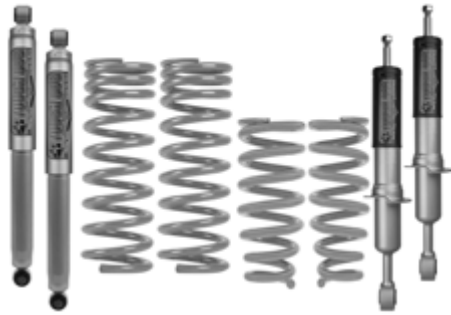
11/05-15  
R51 - 2.5L, 4.0L

### REAR SUSPENSION

SHOCK CHOICE	SPRING CHOICE	RRP inc GST	CONTENTS
<p><b>Foam Cell Struts Require Assembly</b></p> <p><u>Includes</u> 2x Front Struts 2x Rear Shocks 2x Front Coils 2x Rear Coils</p>	<p>TDC771 0-300KG Spring</p> <p>TDC771H CONSTANT 300KG Spring</p> <p>TDC771XHD CONSTANT 500KG Spring</p>		
<p><b>Foam Cell Complete Assembly Struts</b></p> <p><u>Includes</u> 2x Complete Struts 2x Rear Shocks 2x Rear Coils</p>	<p>TDC771 0-300KG Spring</p> <p>TDC771H CONSTANT 300KG Spring</p> <p>TDC771XHD CONSTANT 500KG Spring</p>		
<p><b>40mm Adjustable Struts Require Assembly</b></p> <p><u>Includes</u> 2x Front Struts 2x Rear Shocks 2x Front Coils 2x Rear Coils</p>	<p>TDC771 0-300KG Spring</p> <p>TDC771H CONSTANT 300KG Spring</p> <p>TDC771XHD CONSTANT 500KG Spring</p>		
<p><b>40mm Adjustable Complete Assembly Struts</b></p> <p><u>Includes</u> 2x Complete Struts 2x Rear Shocks 2x Rear Coils</p>	<p>TDC771 0-300KG Spring</p> <p>TDC771H CONSTANT 300KG Spring</p> <p>TDC771XHD CONSTANT 500KG Spring</p>		

Freight should be added where required. When determining spring choice, include only permanent accessories & weights. Towing requirements are not included in constant load determination

# NISSAN

## PATHFINDER

11/05-15

R51 - 3.0L V6



### FRONT SUSPENSION

**ESTIMATED LIFT: 40mm**

PART NO.	QTY	DESCRIPTION	RRP inc GST	NOTES
<b>SHOCK ABSORBERS</b>				
FC404700	2	40mm Foam Cell Strut		
BM404700	2	40mm Adjustable Strut		9 Stage Adjustable
<b>COIL SPRINGS</b>				
TDC772	2	40mm Lift Spring		Petrol/Diesel/Bar
TDC772H	2	40mm Lift Spring		Petrol/Diesel/Bar/Winch
<b>COMPLETE STRUT ASSEMBLY</b>				
NIS-040/06	2	BM404700/TDC772		Petrol/Diesel/Bar
NIS-040/03	2	BM404700/TDC772H		Petrol/Diesel/Bar/Winch
NIS-040/07	2	FC404700/TDC772		Petrol/Diesel/Bar
NIS-040/08	2	FC404700/TDC772H		Petrol/Diesel/Bar/Winch
<b>REPLACEMENT STRUT TOP</b>				
NIS-3030	2	Strut Top		Replacement Strut Top

### REAR SUSPENSION

<b>SHOCK ABSORBERS</b>				
FC41347	2	41mm Foam Cell Shock		Up to 40mm Lift
BM401347	2	40mm 9 Stage Adjustable		Up to 40mm Lift
<b>COIL SPRINGS</b>				
TDC771	2	0-300kg Load		40mm Lift
TDC771H	2	<b>CONSTANT</b> 300Kg Load		40mm Lift
TDC771XHD	2	<b>CONSTANT</b> 500Kg Load		40mm Lift

### REPLACEMENT BUSHINGS

<b>QUANTITY PER SHOCK</b>				
NIS-3030	1	Replacement Strut Top		Available As Complete Unit Only
ADJ00300/40	1	Suits Bottom Front Eying		Eying Bonded Bushing
4W-BS101CH	1	Suits top & bottom rear eyering		

Vehicle fitment sheet must be completed when suspension fitted. Failure to do so may affect warranty.  
Fitment sheet can be found on page 200 of this catalogue

# NISSAN

## PATHFINDER

11/05-15

R51 - 3.0L V6

### REAR SUSPENSION

SHOCK CHOICE	SPRING CHOICE	RRP inc GST	CONTENTS
<p><b>Foam Cell Struts Require Assembly</b></p> <p><u>Includes</u> 2x Front Struts 2x Rear Shocks 2x Front Coils 2x Rear Coils</p>	<p>TDC771 0-300KG Spring</p> <p>TDC771H CONSTANT 300KG Spring</p> <p>TDC771XHD CONSTANT 500KG Spring</p>		
<p><b>Foam Cell Complete Assembly Struts</b></p> <p><u>Includes</u> 2x Complete Struts 2x Rear Shocks 2x Rear Coils</p>	<p>TDC771 0-300KG Spring</p> <p>TDC771H CONSTANT 300KG Spring</p> <p>TDC771XHD CONSTANT 500KG Spring</p>		
<p><b>40mm Adjustable Struts Require Assembly</b></p> <p><u>Includes</u> 2x Front Struts 2x Rear Shocks 2x Front Coils 2x Rear Coils</p>	<p>TDC771 0-300KG Spring</p> <p>TDC771H CONSTANT 300KG Spring</p> <p>TDC771XHD CONSTANT 500KG Spring</p>		
<p><b>40mm Adjustable Complete Assembly Struts</b></p> <p><u>Includes</u> 2x Complete Struts 2x Rear Shocks 2x Rear Coils</p>	<p>TDC771 0-300KG Spring</p> <p>TDC771H CONSTANT 300KG Spring</p> <p>TDC771XHD CONSTANT 500KG Spring</p>		

Freight should be added where required. When determining spring choice, include only permanent accessories & weights. Towing requirements are not included in constant load determination

# NISSAN PATROL

9/80-85 MQ, MK



## FRONT SUSPENSION

**ESTIMATED LIFT: 40mm**

PART NO.	QTY	DESCRIPTION	RRP inc GST	NOTES
<b>SHOCK ABSORBERS</b>				
BD1005T	2	35mm Nitrogen Gas Shock		Suit OE Height
FC41005	2	41mm Foam Cell Shocks		
BM401005	2	40mm 9 Stage Adjustable Shock		
BD1007T	2	35mm Nitrogen Gas		Suit 40mm Lift
FC41007	2	41mm Foam Cell Shocks		
BM401007	2	40mm 9 Stage Adjustable		
<b>LEAF SPRINGS</b>				
BPN-007	2	Petrol/Diesel/Bar		Suits MQ, MK ONLY
BPN-007H	2	Petrol/Diesel/Bar/Winch		Suits MQ, MK ONLY
<b>STEERING STABILIZERS</b>				
EXT5005	1	H/Duty Replacement Damper		
SS5005-P/S	1	Return to Centre Damper		Suits Power Steering
SS5005-M/S	1	Return to Centre Damper		Suits Manual Steering
<b>COMPONENTS</b>				
TDUK-036	1	Urethane Shackle Bushing Kit		Suits MQ O.E Springs
TDUK-009	1	Urethane Shackle Bushing Kit		Suits MQ, MK with T.D Springs
<b>TDUK-009 Bush Kit must be used when fitting Tough Dog leaf springs to both MQ and MK Vehicles</b>				
TDUB-009	1	U-Bolt Kit		Suits MQ, MK
TDUB-004	1	U-Bolt Kit		Suits MQ, MK
TDGP-470	1	Greasable pins		
TDGS-355	1	Greasable Shackles		Suits MQ, OE springs
TDGS-665	1	Greasable Shackles		Suits MQ, MK with T.D Springs
<b>TDGS-665 must be fitted when using Tough Dog springs to both MQ and MK Vehicles</b>				
NAK-005	1	Offset Kingpin		0.5 Degree
NAK-075	1	Offset Kingpin		0.75 Degree
NAK-001	1	Offset Kingpin		1.0 Degree

## REPLACEMENT BUSHINGS

QUANTITY PER SHOCK				
TW959	4	Suits Top & Bottom Front Pin		Pin Style Bushing

Vehicle fitment sheet must be completed when suspension fitted. Failure to do so may affect warranty.  
Fitment sheet can be found on page 200 of this catalogue

# NISSAN PATROL

9/80-85 MQ, MK

## REAR SUSPENSION

PART NO.	QTY	DESCRIPTION	RRP inc GST	NOTES
<b>SHOCK ABSORBERS</b>				
BD1400T	2	35mm Nitrogen Gas Shock		Suit OE Height Suits MQ, MK ONLY
FC41400	2	41mm Foam Cell Shocks		
BM401400	2	40mm 9 Stage Adjustable Shock		
BD1441T	2	35mm Nitrogen Gas		Suit 40mm Lift Suits MQ, MK ONLY
FC41441	2	41mm Foam Cell Shocks		
BM401441	2	40mm 9 Stage Adjustable		
<b>LEAF SPRINGS</b>				
BPN-008	2	0-300kg Load		Suits MQ, MK ONLY
BPN-008H	2	<b>CONSTANT</b> 300Kg Load		Suits MQ, MK ONLY
<b>COMPONENTS</b>				
TDUK-010	1	Urethane Shackle Bushing Kit		Suits MQ, MK
TDUB-010	2	U-Bolt Kit		Suits MQ & MK
TDGP-470	1	Greasable pins		
TDGS-664	1	Greasable Shackles		Suits MQ, MK

## COMPLETE KIT PRICE REFERENCE

SHOCK CHOICE	SPRING CHOICE	RRP inc GST	CONTENTS
<b>35mm Nitro Gas MQ, MK Only</b>	BPN007+BPN008 BPN007H+BPN008 BPN007+BPN008H BPN007H+BPN008H		 <p><b>Includes</b> 4 x Leaf Springs      4 x Shocks 2 x Urethane Bushing Kits 4 x U-Bolt Kits</p>
<b>41mm Foam Cell MQ, MK Only</b>	BPN007+BPN008 BPN007H+BPN008 BPN007+BPN008H BPN007H+BPN008H		
<b>40mm 9 Stage Adjustable MQ, MK Only</b>	BPN007+BPN008 BPN007H+BPN008 BPN007+BPN008H BPN007H+BPN008H		

Freight should be added where required. When determining spring choice, include only permanent accessories & weights. Towing requirements are not included in constant load determination

# NISSAN

## PATROL

2/88-98

GQ Patrol (Y60) - 2" Lift



### FRONT SUSPENSION

**ESTIMATED LIFT: 50mm**

PART NO.	QTY	DESCRIPTION	RRP inc GST	NOTES
<b>SHOCK ABSORBERS</b>				
FC41047	2	41mm Foam Cell Shocks		Suits up to 50mm Lift
BM401047	2	40mm 9 Stage Adjustable Shock		Suits up to 50mm Lift
BMX1047/2	2	45mm 9 Stage Adjustable Shock		Suits 50mm Lift ONLY
TDR1047B	2	53mm 'Ralph' Big Bore Shock		Suits up to 50mm Lift
<b>COIL SPRINGS</b>				
TDC731	2	25mm Lift Coil		Suit SWB with Alloy Bar
TDC734SL	2	25mm Lift Coil		Suit LWB up to Bullbar
TDC734HSL	2	25mm Lift Coil		Suit LWB with Bullbar & Winch
TDC734CL	2	50mm Lift Coil		Suit LWB with 2.8L/Alloy Bar
TDC734L	2	50mm Lift Coil		Suit LWB up to Bullbar
TDC734HL	2	50mm Lift Coil		Suit LWB with Bullbar & Winch
<b>STEERING STABILIZERS</b>				
EXT5612	1	H/Duty Replacement Damper		
SS5612-P/S	1	Return to Centre Damper		Suits 2/88-8/89 GQ ONLY
SV5612	1	9 Stage Adjustable Damper		
EXT5613	1	H/Duty Replacement Damper		
SS5613-P/S	1	Return to Centre Damper		Suits 9/89-98 GQ ONLY
SV5613	1	9 Stage Adjustable Damper		
<b>CASTER CORRECTION</b>				
TDUK-054/2	1	2 Degree Caster Correction Bush		instructions at toughdog.com.au
<b>PANHARD ROD (Check Bushes Prior to Ordering)</b>				
TDPR-004	1	Adjustable Panhard Rod		Suits GQ
TDPR-014	1	Adjustable Panhard Rod		Suits GQ LHD ONLY
<b>COMPONENTS</b>				
TDUK-041	1	Front Radius Rod to Chassis		1 Kit required per vehicle
TDUK-050	1	Front Radius Rod to Diff		1 Kit required per vehicle
TDUK-051	1	Panhard Rod Bush Kit		1 Kit required per panhard rod
TDUK-1734/15	1	Urethane Spring Spacer 15mm		1 required per coil as required
TDUK-1734/30	1	Urethane Spring Spacer 30mm		1 required per coil as required
NAK-005	1	Offset Kingpin		0.5 Degree
NAK-075	1	Offset Kingpin		0.75 Degree
NAK-001	1	Offset Kingpin		1.0 Degree

### REPLACEMENT BUSHINGS

<b>QUANTITY PER SHOCK</b>				
TW967	4	Suits Top & Bottom Front Pin		Pin Style Bushing
ADJ00191	1	Suits Top Rear Eying		Eying Bushing
415024	1	Suits Bottom Rear Eying		Eying Bushing

Vehicle fitment sheet must be completed when suspension fitted. Failure to do so may affect warranty.

Fitment sheet can be found on page 200 of this catalogue



# KIT PRICING REFERENCE COMPONENTS AS PER IMAGE

*please order using part numbers*

# NISSAN

## PATROL

2/88-98  
GQ Patrol (Y60) - 2" Lift

## REAR SUSPENSION

PART NO.	QTY	DESCRIPTION	RRP inc GST	NOTES
<b>SHOCK ABSORBERS - Fitting BMX? instructions at toughdog.com.au</b>				
FC41206	2	41mm Foam Cell Shocks		Suits up to 50mm Lift
BM401206	2	40mm 9 Stage Adjustable Shock		Suits up to 50mm Lift
BMX1206/2	2	45mm 9 Stage Adjustable Shock		Suits 50mm Lift ONLY
TDR1206	2	53mm 'Ralph' Big Bore Shock		Suits up to 50mm Lift
<b>COIL SPRINGS</b>				
TDC733	2	25mm Lift 0-300Kg Load		Suit SWB
TDC732SL	2	25mm Lift 0-300Kg Load		Suit LWB
TDC732HSL	2	25mm Lift <b>CONSTANT 300kg</b>		Suit LWB
TDC732CL	2	50mm Lift No Load (Comfort)		Suit LWB
TDC732L	2	50mm Lift 0-300Kg Load		Suit LWB
TDC749HL	2	50mm Lift <b>CONSTANT 300kg</b>		Suit LWB
<b>PANHARD ROD (Check Bushes Prior to Ordering)</b>				
TDPR-005	1	Adjustable Panhard Rod		Suits GQ
<b>COMPONENTS</b>				
TDUK-052	1	Trailing Arm Bushing Kit		2 Kits required Upper & Lower
TDUK-051	1	Panhard Rod Bush Kit		1 Kit required per panhard rod
TDUK-1736/15	1	Urethane Spring Spacer 15mm		1 required per coil as required
TDUK-1736/30	1	Urethane Spring Spacer 30mm		1 required per coil as required
<b>AIR ASSIST BAGS</b>				
TDAA-008	1	Coil insert bag kit		Suits 50mm Lift

## COMPLETE KIT PRICE REFERENCE

SHOCK CHOICE	SPRING CHOICE	RRP inc GST	CONTENTS
41mm Foam Cell	\$135 Rear Coils		
	\$165 Rear Coils		
40mm 9 Stage Adjustable	\$135 Rear Coils		
	\$165 Rear Coils		
45mm Big Bore 9 Stage Adjustable	\$135 Rear Coils		
	\$165 Rear Coils		
53mm Big Bore 'Ralph'	\$135 Rear Coils		
	\$165 Rear Coils		
<b>Includes</b> 4 x Coil Springs      4 x Shocks			

Freight should be added where required. When determining spring choice, include only permanent accessories & weights. Towing requirements are not included in constant load determination

# NISSAN

## PATROL

12/97-2015

GU Patrol (Y61) - 2" Lift



### FRONT SUSPENSION

**ESTIMATED LIFT: 50mm**

PART NO.	QTY	DESCRIPTION	RRP inc GST	NOTES
<b>SHOCK ABSORBERS</b>				
FC41047	2	41mm Foam Cell Shocks		Suits up to 50mm Lift
BM401047	2	40mm 9 Stage Adjustable Shock		Suits up to 50mm Lift
BMX1047/2	2	45mm 9 Stage Adjustable Shock		Suits 50mm Lift ONLY
TDR1047B	2	53mm 'Ralph' Big Bore Shock		Suits up to 50mm Lift
<b>COIL SPRINGS</b>				
TDC734SL	2	25mm Lift Coil		Suit LWB up to Bullbar
TDC734HSL	2	25mm Lift Coil		Suit LWB with Bullbar & Winch
TDC734L	2	50mm Lift Coil		Suit LWB up to Bullbar
TDC734HL	2	50mm Lift Coil		Suit LWB with Bullbar & Winch
<b>STEERING STABILIZERS</b>				
EXT5000	1	H/Duty Replacement Damper		
SS5000-P/S	1	Return to Centre Damper		Suits 12/97-00 GU ONLY
SV5000	1	9 Stage Adjustable Damper		
EXT5617	1	H/Duty Replacement Damper		
SS5617-P/S	1	Return to Centre Damper		Suits 4/00-15 GU ONLY
SV5617	1	9 Stage Adjustable Damper		
<b>CASTER CORRECTION</b>				
TDUK-054/2	1	2 Degree Caster Correction Bush		instructions at toughdog.com.au
<b>PANHARD ROD (Check Bushes Prior to Ordering)</b>				
TDPR-004	1	Adjustable Panhard Rod		Suits GU Utes
TDPR-012	1	Adjustable Panhard Rod		Suits GU Wagon ONLY
TDPR-014	1	Adjustable Panhard Rod		Suits GU Utes LHD ONLY
TDPR-016	1	Adjustable Panhard Rod		Suits GU Wagon LHD ONLY
<b>COMPONENTS</b>				
TDUK-041	1	Front Radius Rod to Chassis		1 Kit required per vehicle
TDUK-050	1	Front Radius Rod to Diff		1 Kit required per vehicle
TDUK-055	1	Panhard Rod Bush (Diff End)		1 Kit required (diff end only)
TDUK-056	1	Panhard Rod Bush (Chassis End)		1 Kit required (chassis end only)
TDUK-1734/15	1	Urethane Spring Spacer 15mm		1 required per coil as required
TDUK-1734/30	1	Urethane Spring Spacer 30mm		1 required per coil as required
NAK-005	1	Offset Kingpin		0.5 Degree
NAK-075	1	Offset Kingpin		0.75 Degree
NAK-001	1	Offset Kingpin		1.0 Degree

### REPLACEMENT BUSHINGS

QUANTITY PER SHOCK				
TW967	4	Suits Top & Bottom Front Pin		Pin Style Bushing
ADJ00191	1	Suits Top Rear Eying		Eying Bushing
415024	1	Suits Bottom Rear Eying		Eying Bushing

Vehicle fitment sheet must be completed when suspension fitted. Failure to do so may affect warranty.

Fitment sheet can be found on page 200 of this catalogue

# KIT PRICING REFERENCE COMPONENTS AS PER IMAGE

*please order using part numbers*

# NISSAN

## PATROL

12/97-2015  
GU Patrol (Y61) - 2" Lift

## REAR SUSPENSION

PART NO.	QTY	DESCRIPTION	RRP inc GST	NOTES
<b>SHOCK ABSORBERS - Fitting BMX? instructions at toughdog.com.au</b>				
FC41206	2	41mm Foam Cell Shocks		Suits up to 50mm Lift
BM401206	2	40mm 9 Stage Adjustable Shock		Suits up to 50mm Lift
BMX1206/2	2	45mm 9 Stage Adjustable Shock		Suits 50mm Lift ONLY
TDR1206	2	53mm 'Ralph' Big Bore Shock		Suits up to 50mm Lift
<b>COIL SPRINGS</b>				
TDC742SL	2	25mm Lift 0-300Kg Load		Suit LWB
TDC742HSL	2	25mm Lift <b>CONSTANT 300kg</b>		Suit LWB
TDC742L	2	50mm Lift 0-300Kg Load		Suit LWB
TDC742HL	2	50mm Lift <b>CONSTANT 300kg</b>		Suit LWB
<b>PANHARD ROD (Check Bushes Prior to Ordering)</b>				
TDPR-005	1	Adjustable Panhard Rod		Suits GU Utes
TDPR-013	1	Adjustable Panhard Rod		Suits GU Wagon ONLY
<b>COMPONENTS</b>				
TDUK-052	1	Trailing Arm Bushing Kit		2 Kits required Upper & Lower
TDUK-055	1	Panhard Rod Bush (Diff End)		1 Kit required (diff end only)
TDUK-056	1	Panhard Rod Bush (Chassis End)		1 Kit required (chassis end only)
TDUK-1736/15	1	Urethane Spring Spacer 15mm		1 required per coil as required
TDUK-1736/30	1	Urethane Spring Spacer 30mm		1 required per coil as required
<b>AIR ASSIST BAGS</b>				
TDAA-008	1	Coil insert bag kit		Suits 50mm Lift

## COMPLETE KIT PRICE REFERENCE

SHOCK CHOICE	SPRING CHOICE	RRP inc GST	CONTENTS
<b>41mm Foam Cell</b>	\$135 Rear Coils		
	\$165 Rear Coils		
<b>40mm 9 Stage Adjustable</b>	\$135 Rear Coils		
	\$165 Rear Coils		
<b>45mm Big Bore 9 Stage Adjustable</b>	\$135 Rear Coils		
	\$165 Rear Coils		
<b>53mm Big Bore 'Ralph'</b>	\$135 Rear Coils		
	\$165 Rear Coils		
<b>Includes</b> 4 x Coil Springs      4 x Shocks			

*Freight should be added where required. When determining spring choice, include only permanent accessories & weights. Towing requirements are not included in constant load determination*

# NISSAN

## PATROL

2/88-2015

GQ, GU Patrol (Y60, Y61) - 3" Lift



### FRONT SUSPENSION

**ESTIMATED LIFT: 75mm (3")**

PART NO.	QTY	DESCRIPTION	RRP inc GST	NOTES
<b>SHOCK ABSORBERS</b>				
FC41047/3	2	41mm Foam Cell Shocks		Suits 75mm Lift
BM401047/3	2	40mm 9 Stage Adjustable Shock		Suits 75mm Lift
BMX1047/3	2	45mm 9 Stage Adjustable Shock		Suits 75mm Lift
<b>COIL SPRINGS</b>				
TDC734/3	2	75mm Lift Coil		Suit LWB up to Bullbar
TDC734/3H	2	75mm Lift Coil		Suit LWB with Bullbar & Winch
<b>STEERING STABILIZERS</b>				
EXT5612	1	H/Duty Replacement Damper		Suits 2/88-9/89 GQ ONLY
SS5612-P/S	1	Return to Centre Damper		
SV5612	1	9 Stage Adjustable Damper		
EXT5613	1	H/Duty Replacement Damper		Suits 8/89-98 GQ ONLY
SS5613-P/S	1	Return to Centre Damper		
SV5613	1	9 Stage Adjustable Damper		
EXT5000	1	H/Duty Replacement Damper		Suits 12/97-00 GU ONLY
SS5000-P/S	1	Return to Centre Damper		
SV5000	1	9 Stage Adjustable Damper		
EXT5617	1	H/Duty Replacement Damper		Suits 4/00-15 GU ONLY
SS5617-P/S	1	Return to Centre Damper		
SV5617	1	9 Stage Adjustable Damper		
<b>CASTER CORRECTION</b>				
TDUK-054/2	1	2 Degree Caster Correction Bush		instructions at toughdog.com.au
<b>PANHARD ROD (Check Bushes Prior to Ordering)</b>				
TDPR-004	1	Adjustable Panhard Rod		Suits GQ (all) & GU Utes
TDPR-012	1	Adjustable Panhard Rod		Suits GU Wagon ONLY
TDPR-014	1	Adjustable Panhard Rod		Suits GQ (all) & GU Utes LHD
TDPR-016	1	Adjustable Panhard Rod		Suits GU Wagon LHD
<b>COMPONENTS</b>				
TDUK-041	1	Front Radius Rod to Chassis		1 Kit required per vehicle
TDUK-050	1	Front Radius Rod to Diff		1 Kit required per vehicle
TDUK-051	1	Pan Hard Rod Bushes		Suits TDPR-004 & 014 ONLY
TDUK-055	1	Panhard Rod Bush ( <b>Diff End</b> )		(diff end) TDPR-012, 013 & 016
TDUK-056	1	Panhard Rod Bush ( <b>Chassis End</b> )		(chasss end)TDPR-012,013 & 016
NAK-005	1	Offset Kingpin		0.5 Degree
NAK-075	1	Offset Kingpin		0.75 Degree
NAK-001	1	Offset Kingpin		1.0 Degree

### REPLACEMENT BUSHINGS

**FOR REPLACEMENT BUSHING PART NUMBERS, PLEASE SEE RELEVANT NISSAN PATROL PAGES (P104) PREVIOUS IN CATALOGUE**

Vehicle fitment sheet must be completed when suspension fitted. Failure to do so may affect warranty.  
Fitment sheet can be found on page 200 of this catalogue

# KIT PRICING REFERENCE COMPONENTS AS PER IMAGE

*please order using part numbers*

# NISSAN

## PATROL

2/88-2015

GQ, GU Patrol (Y60, Y61) - 3" Lift

## REAR SUSPENSION

PART NO.	QTY	DESCRIPTION	RRP inc GST	NOTES
<b>SHOCK ABSORBERS - Fitting BMX? instructions at toughdog.com.au</b>				
FC41206/3	2	41mm Foam Cell Shocks		Suits 75mm Lift
BM401206/3	2	40mm 9 Stage Adjustable Shock		Suits 75mm Lift
BMX1206/3	2	45mm 9 Stage Adjustable Shock		Suits 75mm Lift
<b>COIL SPRINGS</b>				
TDC732/3	2	75mm Lift 0-300Kg Load		Suit LWB
TDC732/3H	2	75mm Lift <b>CONSTANT 300kg</b>		Suit LWB
<b>PANHARD ROD (Check Bushes Prior to Ordering)</b>				
TDPR-005	1	Adjustable Panhard Rod		Suits GQ (all) & GU Utes
TDPR-013	1	Adjustable Panhard Rod		Suits GU Wagon ONLY
<b>COMPONENTS</b>				
TDUK-051	1	Pan Hard Rod Bushes		Suits TDPR-005 ONLY
TDUK-052	1	Trailing Arm Bushing Kit		2 Kits required Upper & Lower
TDUK-055	1	Panhard Rod Bush (Diff End)		1 Kit required (diff end only)
TDUK-056	1	Panhard Rod Bush (Chassis End)		1 Kit required (chassis end only)
<b>TRANSMISSION SPACER</b>				
TDSP-004/2	1	Transmission Spacer Kit		instructions at toughdog.com.au
<b>BRAKE HOSE KITS</b>				
TDBH-001	1	Non ABS Rubber Hose		SUIT VEHICLES UP TO 2002
TDBH-194	1	Non ABS Braided Hose		SUIT VEHICLES UP TO 2002
TDBH-390	1	With ABS Rubber Hose		SUIT VEHICLES 98 ON
TDBH-190	1	With ABS - Braided Hose		SUIT VEHICLES 98 ON
TDBH-400	1	With ABS & Stability - Rubber		SUIT VEHICLES 98 ON

## COMPLETE KIT PRICE REFERENCE

SHOCK CHOICE	SPRING CHOICE	RRP inc GST	CONTENTS
41mm Foam Cell	TO SUIT GQ TO SUIT GU		
40mm 9 Stage Adjustable	TO SUIT GQ TO SUIT GU		
45mm Big Bore 9 Stage Adjustable	TO SUIT GQ TO SUIT GU		
<b>Includes</b> 4 x Coil Springs      4 x Shocks 1 x Caster correction kit      2 x Panhard Rods 1 x Transmission Spacer      1 x Brake Hose Kit (Brake Hose kit is rubber non ABS - adjust price if required)			

Freight should be added where required. When determining spring choice, include only permanent accessories & weights. Towing requirements are not included in constant load determination

P: (02) 9672 8899 | F: (02) 9672 8099



# NISSAN

## PATROL

2/88-2015

GQ, GU Patrol (Y60, Y61) - 4" Lift



### FRONT SUSPENSION

**ESTIMATED LIFT: 100mm (4")**

PART NO.	QTY	DESCRIPTION	RRP inc GST	NOTES
<b>SHOCK ABSORBERS</b>				
FC41047/4	2	41mm Foam Cell Shocks		Suits 100mm Lift
BMX1047/4/5	2	45mm 9 Stage Adjustable Shock		Suits 100mm Lift
<b>COIL SPRINGS</b>				
TDC734/4	2	100mm Lift Coil		Suit LWB up to Bullbar
TDC734/4H	2	100mm Lift Coil		Suit LWB with Bullbar & Winch
<b>STEERING STABILIZERS</b>				
SS5613-XHD	1	H/Duty Return to Centre Damper		Comes with brackets, fitting instructions at toughdog.com.au
SV5613/4	1	9 Stage Adjustable Damper		
<b>CASTER CORRECTION</b>				
TDUK-054/3	1	3 Degree Caster Correction Bush		instructions at toughdog.com.au
<b>PANHARD ROD (Check Bushes Prior to Ordering)</b>				
TDPR-004	1	Adjustable Panhard Rod		Suits GQ (all) & GU Utes
TDPR-012	1	Adjustable Panhard Rod		Suits GU Wagon ONLY
TDPR-014	1	Adjustable Panhard Rod		Suits GQ (all) & GU Utes LHD
TDPR-016	1	Adjustable Panhard Rod		Suits GU Wagon LHD
<b>COMPONENTS</b>				
TDUK-041	1	Front Radius Rod to Chassis		1 Kit required per vehicle
TDUK-050	1	Front Radius Rod to Diff		1 Kit required per vehicle
TDUK-051	1	Pan Hard Rod Bushes		Suits TDPR-004 & 014 ONLY
TDUK-055	1	Panhard Rod Bush <b>(Diff End)</b>		(diff end) TDPR-012, 013 & 016
TDUK-056	1	Panhard Rod Bush <b>(Chassis End)</b>		(chassis end)TDPR-012,013 & 016
NAK-005	1	Offset Kingpin		0.5 Degree
NAK-075	1	Offset Kingpin		0.75 Degree
NAK-001	1	Offset Kingpin		1.0 Degree

### REPLACEMENT BUSHINGS

**FOR REPLACEMENT BUSHING PART NUMBERS, PLEASE SEE RELEVANT NISSAN PATROL PAGES (P104) PREVIOUS IN CATALOGUE**

Vehicle fitment sheet must be completed when suspension fitted. Failure to do so may affect warranty.  
Fitment sheet can be found on page 200 of this catalogue

# KIT PRICING REFERENCE COMPONENTS AS PER IMAGE

*please order using part numbers*

# NISSAN

## PATROL

2/88-2015

GQ, GU Patrol (Y60, Y61) - 4" Lift

### REAR SUSPENSION

PART NO.	QTY	DESCRIPTION	RRP inc GST	NOTES
<b>SHOCK ABSORBERS - Fitting BMX? instructions at toughdog.com.au</b>				
FC41206/4	2	41mm Foam Cell Shocks		Suits 100mm Lift
BMX1206/4/5	2	45mm 9 Stage Adjustable Shock		Suits 100mm Lift
<b>COIL SPRINGS</b>				
TDC732/4	2	100mm Lift 0-300Kg Load		Suit LWB
TDC732/4H	2	100mm Lift <b>CONSTANT 300kg</b>		Suit LWB
<b>PANHARD ROD (Check Bushes Prior to Ordering)</b>				
TDPR-005	1	Adjustable Panhard Rod		Suits GQ (all) & GU Utes
TDPR-013	1	Adjustable Panhard Rod		Suits GU Wagon ONLY
<b>COMPONENTS</b>				
TDUK-051	1	Pan Hard Rod Bushes		Suits TDPR-005 ONLY
TDUK-052	1	Trailing Arm Bushing Kit		2 Kits required Upper & Lower
TDUK-055	1	Panhard Rod Bush (Diff End)		1 Kit required (diff end only)
TDUK-056	1	Panhard Rod Bush (Chassis End)		1 Kit required (chassis end only)
<b>TRANSMISSION SPACER</b>				
TDSP-004/2	1	Transmission Spacer Kit		instructions at toughdog.com.au
<b>BRAKE HOSE KITS</b>				
TDBH-001	1	Non ABS Rubber Hose		SUIT VEHICLES UP TO 2002
TDBH-194	1	Non ABS Braided Hose		SUIT VEHICLES UP TO 2002
TDBH-390	1	With ABS Rubber Hose		SUIT VEHICLES 98 ON
TDBH-190	1	With ABS - Braided Hose		SUIT VEHICLES 98 ON
TDBH-400	1	With ABS & Stability - Rubber		SUIT VEHICLES 98 ON

**VEHICLES LIFTED 100MM OR MORE REQUIRE THE REAR TAILSHAFT TO BE SPUN 180 DEGREES SO THAT THE CLEARANCE BETWEEN THE CROSS MEMBER AND THE TAILSHAFT IS INCREASED.**

### COMPLETE KIT PRICE REFERENCE

SHOCK CHOICE	SPRING CHOICE	RRP inc GST	CONTENTS
41mm Foam Cell	TO SUIT GQ TO SUIT GU		
45mm Big Bore 9 Stage Adjustable	TO SUIT GQ TO SUIT GU		
<b>Includes</b> 4 x Coil Springs      4 x Shocks 1 x Caster correction kit      2 x Panhard Rods 1 x Transmission Spacer      1 x Brake Hose Kit (Brake Hose kit is rubber non ABS - adjust price if required)			

*Freight should be added where required. When determining spring choice, include only permanent accessories & weights. Towing requirements are not included in constant load determination*

**P: (02) 9672 8899 | F: (02) 9672 8099**



# NISSAN

## PATROL

2/88-2015

GQ, GU Patrol (Y60, Y61) - 5" Lift



### FRONT SUSPENSION

**ESTIMATED LIFT: 125mm (5")**

PART NO.	QTY	DESCRIPTION	RRP inc GST	NOTES
<b>SHOCK ABSORBERS</b>				
BMX1047/4/5	2	45mm 9 Stage Adjustable Shock		Suits 125mm Lift ONLY
<b>COIL SPRINGS</b>				
TDC734/5	2	125mm Lift Coil		Suit LWB up to Bullbar
TDC734/5H	2	125mm Lift Coil		Suit LWB with Bullbar & Winch
<b>STEERING STABILIZERS</b>				
SS5613-XHD	1	H/Duty Return to Centre Damper		Comes with brackets, fitting instructions at toughdog.com.au
SV5613/4	1	9 Stage Adjustable Damper		
<b>CASTER CORRECTION</b>				
TDCP-005	1	5 Degree Caster Correction Plate		instructions at toughdog.com.au
<b>PANHARD ROD (Check Bushes Prior to Ordering)</b>				
TDPR-004	1	Adjustable Panhard Rod		Suits GQ (all) & GU Utes
TDPR-012	1	Adjustable Panhard Rod		Suits GU Wagon ONLY
TDPR-014	1	Adjustable Panhard Rod		Suits GQ (all) & GU Utes LHD
TDPR-016	1	Adjustable Panhard Rod		Suits GU Wagon LHD
<b>COMPONENTS</b>				
TDUK-041	1	Front Radius Rod to Chassis		1 Kit required per vehicle
TDUK-050	1	Front Radius Rod to Diff		1 Kit required per vehicle
TDUK-051	1	Pan Hard Rod Bushes		Suits TDPR-004 & 014 ONLY
TDUK-055	1	Panhard Rod Bush <b>(Diff End)</b>		(diff end) TDPR-012, 013 & 016
TDUK-056	1	Panhard Rod Bush <b>(Chassis End)</b>		(chassis end)TDPR-012,013 & 016
NAK-005	1	Offset Kingpin		0.5 Degree
NAK-075	1	Offset Kingpin		0.75 Degree
NAK-001	1	Offset Kingpin		1.0 Degree

### REPLACEMENT BUSHINGS

**FOR REPLACEMENT BUSHING PART NUMBERS, PLEASE SEE RELEVANT NISSAN PATROL PAGES (P104) PREVIOUS IN CATALOGUE**

Vehicle fitment sheet must be completed when suspension fitted. Failure to do so may affect warranty.  
Fitment sheet can be found on page 200 of this catalogue



**KIT PRICING REFERENCE  
COMPONENTS AS PER IMAGE**

*please order using part numbers*

**NISSAN**

**PATROL**

**2/88-2015**

**GQ, GU Patrol (Y60, Y61) - 5" Lift**

**REAR SUSPENSION**

PART NO.	QTY	DESCRIPTION	RRP inc GST	NOTES
<b>SHOCK ABSORBERS - Shock fitting instructions at toughdog.com.au</b>				
BMX1206/4/5	2	45mm 9 Stage Adjustable Shock		Suits 125mm Lift ONLY
<b>COIL SPRINGS</b>				
TDC732/5	2	125mm Lift 0-300Kg Load		Suit LWB
TDC732/5H	2	125mm Lift <b>CONSTANT 300kg</b>		Suit LWB
<b>PANHARD ROD (Check Bushes Prior to Ordering)</b>				
TDPR-005	1	Adjustable Panhard Rod		Suits GQ (all) & GU Utes
TDPR-013	1	Adjustable Panhard Rod		Suits GU Wagon ONLY
<b>COMPONENTS</b>				
TDUK-051	1	Pan Hard Rod Bushes		Suits TDPR-005 ONLY
TDUK-052	1	Trailing Arm Bushing Kit		2 Kits required Upper & Lower
TDUK-055	1	Panhard Rod Bush (Diff End)		1 Kit required (diff end only)
TDUK-056	1	Panhard Rod Bush (Chassis End)		1 Kit required (chassis end only)
<b>TRANSMISSION SPACER</b>				
TDSP-004/2	1	Transmission Spacer Kit		instructions at toughdog.com.au
<b>BRAKE HOSE KITS</b>				
TDBH-001	1	Non ABS Rubber Hose		SUIT VEHICLES UP TO 2002
TDBH-194	1	Non ABS Braided Hose		SUIT VEHICLES UP TO 2002
TDBH-390	1	With ABS Rubber Hose		SUIT VEHICLES 98 ON
TDBH-190	1	With ABS - Braided Hose		SUIT VEHICLES 98 ON
TDBH-400	1	With ABS & Stability - Rubber		SUIT VEHICLES 98 ON

**VEHICLES LIFTED 100MM OR MORE REQUIRE THE REAR TAILSHAFT TO BE SPUN 180 DEGREES SO THAT THE CLEARANCE BETWEEN THE CROSS MEMBER AND THE TAILSHAFT IS INCREASED.**

**COMPLETE KIT PRICE REFERENCE**

SHOCK CHOICE	SPRING CHOICE	RRP inc GST	CONTENTS
<b>45mm Big Bore 9 Stage Adjustable</b>	<b>TO SUIT GQ (0-300 rear)</b>		
	<b>TO SUIT GQ (300kg + rear)</b>		
	<b>TO SUIT GU (0-300 rear)</b>		
	<b>TO SUIT GU (300kg + rear)</b>		
<p><b>Includes</b></p> <p>4 x Coil Springs      4 x Shocks            1 x Caster correction kit      2 x Panhard Rods            1 x Transmission Spacer      1 x Brake Hose Kit            (Brake Hose kit is rubber non ABS - adjust price if required)</p>			

*Freight should be added where required. When determining spring choice, include only permanent accessories & weights. Towing requirements are not included in constant load determination*

# NISSAN

## PATROL

2/88-2015

GQ, GU Patrol (Y60, Y61) - 6" Lift



### FRONT SUSPENSION

**ESTIMATED LIFT: 150mm (6")**

PART NO.	QTY	DESCRIPTION	RRP inc GST	NOTES
<b>SHOCK ABSORBERS</b>				
BMX1047/6	2	45mm 9 Stage Adjustable Shock		Suits 150mm Lift ONLY
<b>COIL SPRINGS</b>				
TDC734/6	2	150mm Lift Coil		Suit LWB up to Bullbar
TDC734/6H	2	150mm Lift Coil		Suit LWB with Bullbar & Winch
<b>STEERING STABILIZERS</b>				
SS5613-XHD	1	H/Duty Replacement Damper		Comes with brackets, fitting instructions at toughdog.com.au
SV5613/4	1	9 Stage Adjustable Damper		
<b>CASTER CORRECTION</b>				
TDCP-007	1	7 Degree Caster Correction Plate		instructions at toughdog.com.au
<b>PANHARD ROD (Check Bushes Prior to Ordering)</b>				
TDPR-004	1	Adjustable Panhard Rod		Suits GQ (all) & GU Utes
TDPR-012	1	Adjustable Panhard Rod		Suits GU Wagon ONLY
TDPR-014	1	Adjustable Panhard Rod		Suits GQ (all) & GU Utes LHD
TDPR-016	1	Adjustable Panhard Rod		Suits GU Wagon LHD
<b>COMPONENTS</b>				
TDUK-041	1	Front Radius Rod to Chassis		1 Kit required per vehicle
TDUK-050	1	Front Radius Rod to Diff		1 Kit required per vehicle
TDUK-051	1	Pan Hard Rod Bushes		Suits TDPR-004 & 014 ONLY
TDUK-055	1	Panhard Rod Bush <b>(Diff End)</b>		(diff end) TDPR-012, 013 & 016
TDUK-056	1	Panhard Rod Bush <b>(Chassis End)</b>		(chassis end) TDPR-012, 013 & 016
NAK-005	1	Offset Kingpin		0.5 Degree
NAK-075	1	Offset Kingpin		0.75 Degree
NAK-001	1	Offset Kingpin		1.0 Degree

### REPLACEMENT BUSHINGS

**FOR REPLACEMENT BUSHING PART NUMBERS, PLEASE SEE RELEVANT NISSAN PATROL PAGES (P104) PREVIOUS IN CATALOGUE**

Vehicle fitment sheet must be completed when suspension fitted. Failure to do so may affect warranty.  
Fitment sheet can be found on page 200 of this catalogue

**KIT PRICING REFERENCE  
COMPONENTS AS PER IMAGE**

*please order using part numbers*

# NISSAN

## PATROL

2/88-2015

**GQ, GU Patrol (Y60, Y61) - 6" Lift**

### REAR SUSPENSION

PART NO.	QTY	DESCRIPTION	RRP inc GST	NOTES
<b>SHOCK ABSORBERS - Shock fitting instructions at toughdog.com.au</b>				
BMX1206/6	2	45mm 9 Stage Adjustable Shock		Suits 150mm Lift ONLY
<b>COIL SPRINGS</b>				
TDC732/6	2	150mm Lift 0-300Kg Load		Suit LWB
TDC732/6H	2	150mm Lift <b>CONSTANT 300kg</b>		Suit LWB
<b>PANHARD ROD (Check Bushes Prior to Ordering)</b>				
TDPR-005	1	Adjustable Panhard Rod		Suits GQ (all) & GU Utes
TDPR-013	1	Adjustable Panhard Rod		Suits GU Wagon ONLY
<b>COMPONENTS</b>				
TDUK-051	1	Pan Hard Rod Bushes		Suits TDPR-005 ONLY
TDUK-052	1	Trailing Arm Bushing Kit		2 Kits required Upper & Lower
TDUK-055	1	Panhard Rod Bush (Diff End)		1 Kit required (diff end only)
TDUK-056	1	Panhard Rod Bush (Chassis End)		1 Kit required (chassis end only)
<b>TRANSMISSION SPACER</b>				
TDSP-004/2	1	Transmission Spacer Kit		instructions at toughdog.com.au
<b>BRAKE HOSE KITS</b>				
TDBH-001	1	Non ABS Rubber Hose		SUIT VEHICLES UP TO 2002
TDBH-194	1	Non ABS Braided Hose		SUIT VEHICLES UP TO 2002
TDBH-390	1	With ABS Rubber Hose		SUIT VEHICLES 98 ON
TDBH-190	1	With ABS - Braided Hose		SUIT VEHICLES 98 ON
TDBH-400	1	With ABS & Stability - Rubber		SUIT VEHICLES 98 ON

### COMPLETE KIT PRICE REFERENCE

SHOCK CHOICE	SPRING CHOICE	RRP inc GST	CONTENTS
45mm Big Bore 9 Stage Adjustable	SUIT GQ (0-300kg)		
	SUIT GQ (Bar+Winch)		
	SUIT GQ (Bar+Winch+300kg Rear)		
	SUIT GU (0-300kg)		
	SUIT GU (Bar+Winch)		
	SUIT GU (Bar+Winch+300kg Rear)		
<b>Includes</b> 4 x Coil Springs      4 x Shocks 1 x Caster correction kit      2 x Panhard Rods 1 x Transmission Spacer      1 x Brake Hose Kit (Brake Hose kit is rubber non ABS - adjust price if required)			

*Freight should be added where required. When determining spring choice, include only permanent accessories & weights. Towing requirements are not included in constant load determination*

# NISSAN

## PATROL

2/88-98

GQ Cab Chassis (Leaf/Leaf)



### FRONT SUSPENSION

**ESTIMATED LIFT: 50mm**

PART NO.	QTY	DESCRIPTION	RRP inc GST	NOTES
<b>SHOCK ABSORBERS</b>				
FC41108	2	41mm Foam Cell Shocks		Suit OE Height
BM401108	2	40mm 9 Stage Adjustable Shock		
FC41113	2	41mm Foam Cell Shocks		Suit 50mm Lift
BM401113	2	40mm 9 Stage Adjustable		
<b>LEAF SPRINGS</b>				
FS37	2	50mm Lift Spring		Petrol/Diesel/Bar
FS37H	2	50mm Lift Spring		Petrol/Diesel/Bar/Winch
<b>STEERING STABILIZERS</b>				
EXT5005	1	H/Duty Replacement Damper		Eye/Eye Mounting
SS5005-P/S	1	Return to Centre Damper		Check Vehicle Prior to Ordering.
EXT5613	1	H/Duty Replacement Damper		Pin/Pin Mounting
SS5613-P/S	1	Return to Centre Damper		Check Vehicle Prior to Ordering.
SV5613	1	9 Stage Adjustable Dampers		
<b>COMPONENTS</b>				
TDUK-011	1	Urethane Shackle Bushing Kit		
TDUB-011	2	U-Bolt Kit		
TDGP-667	1	Greasable pins		
TDGS-666	1	Greasable Shackles		
NAK-005	1	Offset Kingpin		0.5 Degree
NAK-075	1	Offset Kingpin		0.75 Degree
NAK-001	1	Offset Kingpin		1.0 Degree

### REPLACEMENT BUSHINGS

<b>QUANTITY PER SHOCK</b>				
TW959	2	Suits Top Front Pin		Pin Style Bushing
ADJ00191	1	Suits Bottom Front Eying		Eying Bushing
ADJ00191	1	Suits Top Rear Eying		Eying Bushing
TW959	2	Suits Bottom Rear Pin		Pin Style Bushing

Vehicle fitment sheet must be completed when suspension fitted. Failure to do so may affect warranty.

Fitment sheet can be found on page 200 of this catalogue



**KIT PRICING REFERENCE  
COMPONENTS AS PER IMAGE**  
*please order using part numbers*

**NISSAN**  
**PATROL**  
2/88-98  
**GQ Cab Chassis (Leaf/Leaf)**

**REAR SUSPENSION**

PART NO.	QTY	DESCRIPTION	RRP inc GST	NOTES
<b>SHOCK ABSORBERS</b>				
FC41404	2	41mm Foam Cell Shocks		Suit 50mm Lift
BM401404	2	40mm 9 Stage Adjustable		
<b>LEAF SPRINGS</b>				
BPN-010	2	0-300kg Load		50mm Lift Spring
BPN-010H	2	<b>CONSTANT</b> 300Kg Load		50mm Lift Spring
FS39M	2	<b>CONSTANT</b> 500Kg Load		50mm Lift Spring
FS38M	2	<b>Mine Spec - CONSTANT GVM</b>		50mm Lift Spring
<b>COMPONENTS</b>				
TDUK-012	1	Urethane Shackle Bushing Kit		
TDUB-025	2	U-Bolt Kit		
TDGP-667	1	Greasable pins		
TDGS-357	1	Greasable Shackles		
<b>AIR ASSIST BAGS</b>				
TDAA-110	1	Bellows bag kit		Suits 50mm Lift

**COMPLETE KIT PRICE REFERENCE**

SHOCK CHOICE	SPRING CHOICE	RRP inc GST	CONTENTS
<b>41mm Foam Cell</b>	FS37+BPN-010		
	FS37H+BPN-010		
	FS37+BPN-010H		
	FS37H+BPN010H		
	FS37+FS38/39M		
	FS37H+FS38/39M		
<b>40mm 9 Stage Adjustable</b>	FS37+BPN-010		
	FS37H+BPN-010		
	FS37+BPN-010H		
	FS37H+BPN010H		
	FS37+FS38/39M		
	FS37H+FS38/39M		
<b>Includes</b> 4 x Leaf Springs      4 x Shocks 2 x Urethane Kits      4 x U-Bolt Kits			

*Freight should be added where required. When determining spring choice, include only permanent accessories & weights. Towing requirements are not included in constant load determination*

# NISSAN

## PATROL

92-15

GQ, GU Cab Chassis (Coil/Leaf)



### FRONT SUSPENSION

**ESTIMATED LIFT: 50mm**

PART NO.	QTY	DESCRIPTION	RRP inc GST	NOTES
<b>SHOCK ABSORBERS</b>				
FC41047	2	41mm Foam Cell Shocks		Suits up to 50mm Lift
BM401047	2	40mm 9 Stage Adjustable Shock		Suits up to 50mm Lift
BMX1047/2	2	45mm 9 Stage Adjustable Shock		Suits 50mm Lift ONLY
TDR1047B	2	53mm 'Ralph' Big Bore Shock		Suits up to 50mm Lift
<b>COIL SPRINGS</b>				
TDC734L	2	50mm Lift Coil		Suit up to Bullbar
TDC734HL	2	50mm Lift Coil		Suit with Bullbar & Winch
<b>STEERING STABILIZERS</b>				
EXT5613	1	H/Duty Replacement Damper		Suits GQ ONLY (Pin/Pin)
SS5613-P/S	1	Return to Centre Damper		<b>Please Check Mountings Prior to Ordering - Model is not consistent in application.</b>
SV5613	1	9 Stage Adjustable Damper		
EXT5000	1	H/Duty Replacement Damper		Suits GU ONLY (Pin/Pin)
SS5000-P/S	1	Return to Centre Damper		<b>Please Check Mountings Prior to Ordering - Model is not consistent in application.</b>
SV5000	1	9 Stage Adjustable Damper		
<b>CASTER CORRECTION</b>				
TDUK-054/2	1	2 Degree Caster Correction Bush		1 Kit required per vehicle
<b>PANHARD ROD (Check Bushes Prior to Ordering)</b>				
TDPR-004	1	Adjustable Panhard Rod		Suits GQ & GU Utes
TDPR-014	1	Adjustable Panhard Rod		Suits GQ & GU Utes LHD
<b>COMPONENTS</b>				
TDUK-041	1	Front Radius Rod to Chassis		1 Kit required per vehicle
TDUK-050	1	Front Radius Rod to Diff		1 Kit required per vehicle
TDUK-051	1	Panhard Rod Bush Kit		1 Kit required per panhard rod
TDUK-1734/15	1	Urethane Spring Spacer 15mm		1 required per coil as required
TDUK-1734/30	1	Urethane Spring Spacer 30mm		1 required per coil as required
NAK-005	1	Offset Kingpin		0.5 Degree
NAK-075	1	Offset Kingpin		0.75 Degree
NAK-001	1	Offset Kingpin		1.0 Degree

### REPLACEMENT BUSHINGS

<b>QUANTITY PER SHOCK</b>				
TW967	4	Suits Top & Bottom Front Pin		Pin Style Bushing
ADJ00191	1	Suits Top Rear Eying		Eying Bushing
TW959	2	Suits Bottom Rear Pin		Pin Style Bushing

Vehicle fitment sheet must be completed when suspension fitted. Failure to do so may affect warranty.  
Fitment sheet can be found on page 200 of this catalogue

# KIT PRICING REFERENCE COMPONENTS AS PER IMAGE

*please order using part numbers*

# NISSAN

## PATROL

92-15

GQ, GU Cab Chassis (Coil/Leaf)

### REAR SUSPENSION

PART NO.	QTY	DESCRIPTION	RRP inc GST	NOTES
<b>SHOCK ABSORBERS</b>				
FC41404	2	41mm Foam Cell Shocks		Suits up to 50mm Lift
BM401404	2	40mm 9 Stage Adjustable		Suits up to 50mm Lift
BMX1404/2	2	45mm 9 Stage Adjustable Shock		Suits 50mm Lift ONLY
TDR1404	2	53mm 'Ralph' Big Bore Shock		Suits up to 50mm Lift
<b>LEAF SPRINGS</b>				
BPN-010	2	0-300kg Load		50mm Lift Spring
BPN-010H	2	<b>CONSTANT</b> 300Kg Load		50mm Lift Spring
FS39M	2	<b>CONSTANT</b> 500Kg Load		50mm Lift Spring
FS38M	2	<b>Mine Spec - CONSTANT GVM</b>		50mm Lift Spring
<b>COMPONENTS</b>				
TDUK-012	1	Urethane Shackle Bushing Kit		
TDUB-023	2	U-Bolt Kit		
TDGP-667	1	Greasable pins		
TDGS-666	1	Greasable Shackles		
<b>AIR ASSIST BAGS</b>				
TDAA-111	1	Bellows bag kit		Suits 50mm Lift

### COMPLETE KIT PRICE REFERENCE

SHOCK CHOICE	SPRING CHOICE	RRP inc GST	CONTENTS
41mm Foam Cell	BPN-010 BPN-010H FS38/39M		
40mm 9 Stage Adjustable	BPN-010 BPN-010H FS38/39M		
45mm Big Bore 9 Stage Adjustable	BPN-010 BPN-010H FS38/39M		
53mm Big Bore 'Ralph'	BPN-010 BPN-010H FS38/39M		
<b>Includes</b> 2 x Coil Springs      4 x Shocks 2 x Leaf Springs      1 x Urethane Kit 2 x U-Bolt Kits			

# NISSAN

## PATROL

92-15

GQ, GU Cab Chassis (Coil/Coil)



### FRONT SUSPENSION

**ESTIMATED LIFT: 50mm**

PART NO.	QTY	DESCRIPTION	RRP inc GST	NOTES
<b>SHOCK ABSORBERS</b>				
FC41047	2	41mm Foam Cell Shocks		Suits up to 50mm Lift
BM401047	2	40mm 9 Stage Adjustable Shock		Suits up to 50mm Lift
BMX1047/2	2	45mm 9 Stage Adjustable Shock		Suits 50mm Lift ONLY
TDR1047B	2	53mm 'Ralph' Big Bore Shock		Suits up to 50mm Lift
<b>COIL SPRINGS</b>				
TDC734L	2	50mm Lift Coil		Suit up to Bullbar
TDC734HL	2	50mm Lift Coil		Suit with Bullbar & Winch
<b>STEERING STABILIZERS</b>				
EXT5613	1	H/Duty Replacement Damper		Suits GQ ONLY (Pin/Pin)
SS5613-P/S	1	Return to Centre Damper		<b>Please Check Mountings Prior to Ordering - Model is not consistent in application.</b>
SV5613	1	9 Stage Adjustable Damper		
EXT5000	1	H/Duty Replacement Damper		Suits GU ONLY (Pin/Pin)
SS5000-P/S	1	Return to Centre Damper		<b>Please Check Mountings Prior to Ordering - Model is not consistent in application.</b>
SV5000	1	9 Stage Adjustable Damper		
<b>CASTER CORRECTION</b>				
TDUK-054/2	1	2 Degree Caster Correction Bush		1 Kit required per vehicle
<b>PANHARD ROD (Check Bushes Prior to Ordering)</b>				
TDPR-004	1	Adjustable Panhard Rod		Suits GQ & GU Utes
<b>COMPONENTS</b>				
TDUK-041	1	Front Radius Rod to Chassis		1 Kit required per vehicle
TDUK-050	1	Front Radius Rod to Diff		1 Kit required per vehicle
TDUK-051	1	Panhard Rod Bush Kit		1 Kit required per panhard rod
TDUK-1734/15	1	Urethane Spring Spacer 15mm		1 required per coil as required
TDUK-1734/30	1	Urethane Spring Spacer 30mm		1 required per coil as required
NAK-005	1	Offset Kingpin		0.5 Degree
NAK-075	1	Offset Kingpin		0.75 Degree
NAK-001	1	Offset Kingpin		1.0 Degree

### REPLACEMENT BUSHINGS

<b>QUANTITY PER SHOCK</b>				
TW967	4	Suits Top & Bottom Front Pin		Pin Style Bushing
ADJ00191	1	Suits Top Rear Eying		Eying Bushing
415024	1	Suits Bottom Rear Eying		Eying Bushing

Vehicle fitment sheet must be completed when suspension fitted. Failure to do so may affect warranty.

Fitment sheet can be found on page 200 of this catalogue



**KIT PRICING REFERENCE  
COMPONENTS AS PER IMAGE**

*please order using part numbers*

# NISSAN

## PATROL

92-15

**GQ, GU Cab Chassis (Coil/Coil)**

### REAR SUSPENSION

PART NO.	QTY	DESCRIPTION	RRP inc GST	NOTES
<b>SHOCK ABSORBERS - Fitting BMX? instructions at toughdog.com.au</b>				
FC41206	2	41mm Foam Cell Shocks		Suits up to 50mm Lift
BM401206	2	40mm 9 Stage Adjustable Shock		Suits up to 50mm Lift
BMX1206/2	2	45mm 9 Stage Adjustable Shock		Suits 50mm Lift ONLY
TDR1206	2	53mm 'Ralph' Big Bore Shock		Suits up to 50mm Lift
<b>COIL SPRINGS</b>				
TDC749HL	2	50mm Lift 0-300Kg Load		
TDC749VHL	2	50mm Lift <b>CONSTANT 300kg</b>		
<b>PANHARD ROD (Check Bushes Prior to Ordering)</b>				
TDPR-005	1	Adjustable Panhard Rod		
<b>COMPONENTS</b>				
TDUK-051	1	Pan Hard Rod Bushes		Suits TDPR-005 ONLY
TDUK-052	1	Trailing Arm Bushing Kit		2 Kits required Upper & Lower
TDUK-1736/15	1	Urethane Spring Spacer 15mm		1 required per coil as required
TDUK-1736/30	1	Urethane Spring Spacer 30mm		1 required per coil as required

### COMPLETE KIT PRICE REFERENCE

SHOCK CHOICE	SPRING CHOICE	RRP inc GST	CONTENTS
<b>41mm Foam Cell</b>	\$165 Rear Coils		
	\$196 Rear Coils		
<b>40mm 9 Stage Adjustable</b>	\$165 Rear Coils		
	\$196 Rear Coils		
<b>45mm Big Bore 9 Stage Adjustable</b>	\$165 Rear Coils		
	\$196 Rear Coils		
<b>53mm Big Bore 'Ralph'</b>	\$165 Rear Coils		
	\$196 Rear Coils		
<p align="center"><b>Includes</b> 4 x Coil Springs      4 x Shocks</p>			

*Freight should be added where required. When determining spring choice, include only permanent accessories & weights. Towing requirements are not included in constant load determination*

**P: (02) 9672 8899 | F: (02) 9672 8099**



# NISSAN

## PATROL

10 On

Y62 (Non Hydraulic Suspension Only)



### FRONT SUSPENSION

**ESTIMATED LIFT: 40mm**

PART NO.	QTY	DESCRIPTION	RRP inc GST	NOTES
<b>SHOCK ABSORBERS</b>				
FC404750	2	40mm Foam Cell Strut		
BM404750	2	40mm Adjustable Strut		9 Stage Adjustable
BMX454750	2	45mm Adjustable Strut		9 Stage Big Bore Adjustable
<b>COIL SPRINGS</b>				
TDC790L	2	40mm Lift Spring		Petrol With Bar
TDC790HL	2	40mm Lift Spring		Petrol with Bar & Winch
TDC791L	2	40mm Lift Spring-45mm Adj Only		Petrol With Bar
TDC791HL	2	40mm Lift Spring-45mm Adj Only		Petrol with Bar & Winch
<b>COMPLETE STRUT ASSEMBLY</b>				
NIS-062/02	2	FC404750/TDC790L		Petrol With Bar
NIS-062/03	2	FC404750/TDC790HL		Petrol with Bar & Winch
NIS-062/07	2	BM404750/TDC790L		Petrol With Bar
NIS-062/08	2	BM404750/TDC790HL		Petrol with Bar & Winch
NIS-062/10	2	BMX454750/TDC791L (45mm)		Petrol With Bar
NIS-062/11	2	BMX454750/TDC791HL (45mm)		Petrol with Bar & Winch
<b>REPLACEMENT STRUT TOP</b>				
NIS-062	2	Strut Top		Replacement Strut Top

### REAR SUSPENSION

<b>SHOCK ABSORBERS</b>				
FC41220	2	41mm Foam Cell Shock		Up to 40mm Lift
BM401220	2	40mm 9 Stage Adjustable		Up to 40mm Lift
BMX1220/2	2	45mm 9 Stage Adjustable		Up to 40mm Lift
<b>COIL SPRINGS</b>				
TDC795	2	0-120kg Load		40mm Lift
TDC795L	2	<b>CONSTANT</b> 120-300Kg Load		40mm Lift
TDC795HL	2	<b>CONSTANT</b> 300Kg Load		40mm Lift

### REPLACEMENT BUSHINGS

QUANTITY PER SHOCK				
NIS-062	1	Replacement Strut Top		Available As Complete Unit Only
4WAY-002	1	Suits Bottom Front Eying		Eying Bonded Bushing
Retainer-W	1	Suits Rear Top Pin		Eying Bushing
Retainer-X	1	Suits Rear Bottom Pin		Eying Bushing

Vehicle fitment sheet must be completed when suspension fitted. Failure to do so may affect warranty.

Fitment sheet can be found on page 200 of this catalogue

# NISSAN

PATROL

13 On

Y62 (Non Hydraulic Suspension Only)

## COMPLETE KIT PRICE REFERENCE

SHOCK CHOICE	SPRING CHOICE	RRP inc GST	CONTENTS
<b>Foam Cell Struts Require Assembly</b> <u>Includes</u> 4 x Coil Springs 4 x Shocks	\$165 Rear Coils		
	\$185 Rear Coils		
<b>Foam Cell Complete Assembly Struts</b> <u>Includes</u> 2 x Front Strut Assy 2 x Coil Springs 2 x Rear Shocks	\$165 Rear Coils		
	\$185 Rear Coils		
<b>40mm Adjustable Struts Require Assembly</b> <u>Includes</u> 4 x Coil Springs 4 x Shocks	\$165 Rear Coils		
	\$185 Rear Coils		
<b>40mm Adjustable Complete Assembly Struts</b> <u>Includes</u> 2 x Front Strut Assy 2 x Coil Springs 2 x Rear Shocks	\$165 Rear Coils		
	\$185 Rear Coils		
<b>45mm Adjustable Struts Require Assembly</b> <u>Includes</u> 4 x Coil Springs 4 x Shocks	\$165 Rear Coils		
	\$185 Rear Coils		
<b>45mm Adjustable Complete Assembly Struts</b> <u>Includes</u> 2 x Front Strut Assy 2 x Coil Springs 2 x Rear Shocks	\$165 Rear Coils		
	\$185 Rear Coils		

Freight should be added where required. When determining spring choice, include only permanent accessories & weights. Towing requirements are not included in constant load determination

# NISSAN

## TERRANO II

3/97-00

R20



### FRONT SUSPENSION

ESTIMATED LIFT: 30mm

PART NO.	QTY	DESCRIPTION	RRP inc GST	NOTES
<b>SHOCK ABSORBERS</b>				
BD2057T	2	35mm Nitro Gas Shock		Up to 30mm Lift
FC42057B	2	41mm Foam Cell Shock		Up to 30mm Lift
<b>TORSION BARS</b>				
4WTB-1458	1	Replacement Torsion Bars		26mm/1232mm
<b>Adjust Torsion bars after fitting shocks - Ensure a minimum of 60mm Droop is Maintained</b>				

### REAR SUSPENSION

<b>SHOCK ABSORBERS</b>				
BD1388T	2	35mm Nitro Gas Shock		Up to 30mm Lift
FC41388	2	41mm Foam Cell Shock		Up to 30mm Lift
BM401388	2	40mm 9 Stage Adjustable		Up to 30mm Lift
<b>COIL SPRINGS</b>				
TDC739	2	0-300Kg Load		30mm Lift
TDC739H	2	<b>CONSTANT</b> 300Kg Load		30mm Lift

### REPLACEMENT BUSHINGS

QUANTITY PER SHOCK				
TW959	2	Suits Top Front Pin Mount		Pin Style Bushing
412772	1	Suits Bottom Front Eying		Eying Bushing
404702	2	Suits Top & Bottom Rear Eying		Eying Bushing

### COMPLETE KIT PRICE REFERENCE

SHOCK CHOICE	SPRING CHOICE	RRP inc GST	CONTENTS
35mm Nitro gas	ANY		
41mm Foam Cell	ANY		
Foam Cell Front Adjustable Rear	ANY		
<b>Includes</b> 2 x Coil Springs    4 x Shocks			

Vehicle fitment sheet must be completed when suspension fitted. Failure to do so may affect warranty.  
Fitment sheet can be found on page 200 of this catalogue



# SSANGYONG

MUSSO (INC SPORT UTE)

8/96-04

ALSO SEE DAEWOO

## FRONT SUSPENSION

ESTIMATED LIFT: 35mm

PART NO.	QTY	DESCRIPTION	RRP inc GST	NOTES
<b>SHOCK ABSORBERS</b>				
BD2057T	2	35mm Nitrogen Gas Shock		Suits up to 35mm Lift
<b>TORSION BARS</b>				
4WTB-1800	1	Replacement Torsion Bars (Pair)		26mm/1040mm
<b>Adjust Torsion bars after fitting shocks - Ensure a minimum of 60mm Droop is Maintained</b>				

## REAR SUSPENSION

<b>SHOCK ABSORBERS</b>				
BD1104T	2	35mm Nitrogen Gas Shock		Suit OE Height
BM401104	2	40mm 9 Stage Adjustable Shock		
BD1105T	2	35mm Nitrogen Gas		Suit 35mm Lift
BM401105	2	40mm 9 Stage Adjustable		
<b>COIL SPRINGS</b>				
TDC100	2	0-300KG Load		35mm Lift
TDC100H	2	<b>CONSTANT</b> 300Kg Load		35mm Lift

## REPLACEMENT BUSHINGS

QUANTITY PER SHOCK				
TW959	2	Front Top Pin Mount		Pin Style Bushing
412772	1	Bottom Front Eyinging		Eyinging Bushing
TW959	2	Rear Top Pin Mount		Pin Style Bushing
404702	1	Bottom Rear Eyinging		Eyinging Bushing

## COMPLETE KIT PRICE REFERENCE

SHOCK CHOICE	SPRING CHOICE	RRP inc GST	CONTENTS
35mm Nitrogen Gas	ANY		
Gas Front Adjustable Rear	ANY		
<b>Includes</b>			
4 x Shocks    2 x Coil Springs			

Freight should be added where required. When determining spring choice, include only permanent accessories & weights. Towing requirements are not included in constant load determination

# SUZUKI

## JIMNY

10/98-2017

SN413 (JB33/43/48)



### FRONT SUSPENSION

**ESTIMATED LIFT: 40-80mm**

PART NO.	QTY	DESCRIPTION	RRP inc GST	NOTES
<b>SHOCK ABSORBERS</b>				
BD1133TB	2	35mm Nitro Gas Shock		Suits 40mm Lift ONLY
BD1134TB	2	35mm Nitro Gas Shock		Suits 60 & 80mm Lift
<b>COIL SPRINGS</b>				
TDC836	2	40mm Lift Coil		
TDC838L	2	60mm Lift Coil		Suits 10/98-05 1.3L
TDC824	2	80mm Lift Coil		
TDC824H	2	80mm Lift Coil		Suits with Bar & Winch
TDC838L	2	40mm Lift Coil		
TDC824	2	60mm Lift Coil		Suits 05 On M13AAVVT 1.5L
TDC824H	2	80mm Lift Coil		
<b>STEERING STABILIZERS</b>				
SD5610	1	H/Duty Replacement Damper		
SS5610-M/S	1	Return to Centre Damper		Includes Mounting Brackets
SV5610	1	9 Stage Adjustable Damper		Fitting instructions available at toughdog.com.au
<b>CASTER CORRECTION</b>				
TDUK-063	1	3 Degree Caster Correction Bush		1 Kit required per vehicle
<b>PANHARD ROD</b>				
TDPR-009	1	Adjustable Panhard Rod		Suits RHD Vehicles Only
TDPR-011	1	Adjustable Panhard Rod		Suits LHD Vehicles Only
<b>COMPONENTS</b>				
TDUK-039	1	Replacement Trailing Arm Bushes		(0 Degrees Adjustment)
TDSK-022	1	ABS relocation Bracket		Relocation Bracket for ABS Kit fitting instructions at toughdog.com.au

### REPLACEMENT BUSHINGS

<b>QUANTITY PER SHOCK</b>				
402267	2	Suits Top Front Pin Mount		Pin Style Bushing
412772	1	Suits Bottom Front Eying		Eying Bushing
412773	1	Suits Top Rear Eying		Eying Bushing
4W-SPF420-02	1	Suits Bottom Rear Eying		Eying Bushing

Vehicle fitment sheet must be completed when suspension fitted. Failure to do so may affect warranty.  
Fitment sheet can be found on page 200 of this catalogue

**Note: Castor Correction Bushing kit fitting instructions available at [toughdog.com.au](http://toughdog.com.au)**

# SUZUKI



## JIMNY

10/98-2017  
SN413 (JB33/43/48)

### REAR SUSPENSION

PART NO.	QTY	DESCRIPTION	RRP inc GST	NOTES
<b>SHOCK ABSORBERS</b>				
BD1192TB	2	35mm Nitro Gas Shock		Suits 40mm Lift ONLY
BD1193TB	2	35mm Nitro Gas Shock		Suits 60 & 80mm Lift
<b>COIL SPRINGS</b>				
TDC837	2	40mm Lift Coil		
TDC839L	2	60mm Lift Coil		
TDC825	2	80mm Lift Coil		
TDC826	2	80mm Lift Coil - O/S MODELS		
<b>COMPONENTS</b>				
TDUK-039	1	Replacement Trailing Arm Bushes		
<b>PANHARD ROD</b>				
TDPR-010	1	Adjustable Panhard Rod		
<b>BRAKE HOSE KITS</b>				
TDBH-199	1	Brake Hose Kit 60-80mm		Single Rear Hose (Front not req'd)

### COMPLETE KIT PRICE REFERENCE

SHOCK CHOICE	SPRING CHOICE	RRP inc GST	CONTENTS
35mm Nitro Gas	40mm LIFT		
<p><b>Includes</b> 4 x Coil Springs      4 x Shocks</p>			
35mm Nitro Gas	60 & 80mm LIFT		
<p><b>Includes</b> 4 x Coil Springs      4 x Shocks 1 x Caster correction kit      2 x Panhard Rods 1 x Brake Hose Kit      1 x ABS Relocation Bracket</p>			

Freight should be added where required. When determining spring choice, include only permanent accessories & weights. Towing requirements are not included in constant load determination

# SUZUKI

**JIMNY**  
**2019 ON**  
**JB74**



## FRONT SUSPENSION

**ESTIMATED LIFT: 40-80mm**

PART NO.	QTY	DESCRIPTION	RRP inc GST	NOTES
<b>SHOCK ABSORBERS</b>				
FC31000	2	Foam Cell Shock		Suits 40mm Lift ONLY
FC31001	2	Foam Cell Shock		Suits 60 & 80mm Lift
<b>COIL SPRINGS</b>				
TDC1000	2	40mm Lift Coil		<b>Note: When Bar or Bar &amp; Winch fitted, also fit TDUK-084 spacer listed below</b>
TDC1001	2	60mm Lift Coil		
TDC1002	2	80mm Lift Coil		
<b>STEERING STABILIZERS</b>				
EXT5928	1	H/Duty Replacement Damper		
SS5928-P/S	1	Return to Centre Damper		
SV5928	1	9 Stage Adjustable Damper		
<b>CASTER CORRECTION</b>				
TDUK-063	1	3 Degree Caster Correction Bush		1 kit required with 60 or 80mm lift
<b>PANHARD ROD</b>				
TDPR-021	1	Adjustable Panhard Rod		Suits RHD Vehicles Only
<b>COMPONENTS</b>				
TDUK-039	1	Replacement Trailing Arm Bushes		(0 Degrees Adjustment)
TDSP-016	1	ABS relocation & vacuum hoses		Fit with all kits
TDSP-017	1	Headlight Module Bracket		Fit with all kits
TDSP-018	1	Crossmember Drop Kit		Fit with all kits
TDUK-084	1	Front Coil Spacer (pair of)		Fit with bar or Bar + Winch

## REPLACEMENT BUSHINGS

<b>QUANTITY PER SHOCK</b>				
402267	2	Suits Top Front Pin Mount		Pin Style Bushing
412773	1	Suits Bottom Front Eying		Eying Bushing
412773	1	Suits Top Rear Eying		Eying Bushing
412773	1	Suits Bottom Rear Eying		Suits #31002 shock only

Vehicle fitment sheet must be completed when suspension fitted. Failure to do so may affect warranty.  
Fitment sheet can be found on page 200 of this catalogue



**Note: Castor Correction Bushing kit fitting instructions available at [toughdog.com.au](http://toughdog.com.au)**

# SUZUKI

## JIMNY



### 2019 ON

### JB74

## REAR SUSPENSION

PART NO.	QTY	DESCRIPTION	RRP inc GST	NOTES
<b>SHOCK ABSORBERS</b>				
FC31002	2	Foam Cell Shock		Suits 40mm Lift ONLY
FC31003	2	Foam Cell Shock		Suits 60 & 80mm Lift
<b>COIL SPRINGS</b>				
TDC1003	2	40mm Lift Coil		
TDC1004	2	60mm Lift Coil		
TDC1005	2	80mm Lift Coil		
<b>COMPONENTS</b>				
TDUK-039	1	Replacement Trailing Arm Bushes		
<b>PANHARD ROD</b>				
TDPR-010	1	Adjustable Panhard Rod		Fit with 60 & 80mm Lift
<b>BRAKE HOSE KITS</b>				
TDBH-401	1	Rubber Brake Hose Kit		Fit with 60 & 80mm Lift
TDBH-402	1	Braided Brake Hose Kit		Fit with 60 & 80mm Lift
TDBH-403	1	Rubber Brake Hose Kit		Fit with all 40mm Lift

## COMPLETE KIT PRICE REFERENCE

SHOCK CHOICE	SPRING CHOICE	RRP inc GST	CONTENTS
Foam Cell	40mm LIFT		
<p><b>Includes</b></p> <p>4 x Coil Springs    4 x Shocks    1 x Headlight Module Kit            1 x Brake hose kit    1 x ABS Relocation Kit    1 x Crossmember Kit</p>			
Foam Cell	60 & 80mm LIFT		
<p><b>Includes</b></p> <p>4 x Coil Springs    4 x Shocks            1 x Caster Correction Kit    2 x Panhard Rods            1 x Brake Hose Kit    1 x Headlight Module Kit            1 x ABS Relocation Kit    1 x Crossmember Kit</p>			

Freight should be added where required. When determining spring choice, include only permanent accessories & weights. Towing requirements are not included in constant load determination

# SUZUKI

## SIERRA

7/74-5/99  
LEAF SPRING ONLY



### FRONT SUSPENSION

**ESTIMATED LIFT: 50mm**

PART NO.	QTY	DESCRIPTION	RRP inc GST	NOTES
<b>SHOCK ABSORBERS</b>				
BD1102T	2	35mm Nitro Gas Shock		Suits up to 50mm Lift
<b>LEAF SPRINGS</b>				
T61	2	50mm Lift Lift		Suits All with Bar
<b>STEERING STABILIZERS</b>				
SD14030	1	H/Duty Replacement Damper		
SS5611-M/S	1	Return to Centre Damper		
<b>COMPONENTS</b>				
TDUK-013	1	Urethane Shackle Bushing Kit		
TDUB-014	1	U-Bolt Kit		Passenger Side
TDUB-013	1	U-Bolt Kit		Drivers Side
TDGS-656	1	Greasable Shackle Kit		

### REAR SUSPENSION

<b>SHOCK ABSORBERS</b>				
BD1364T	2	35mm Nitro Gas Shock		Suits OE Height
BD1366T	2	35mm Nitro Gas Shock		Suits 50mm Lift
BD1102T	2	35mm Nitro Gas Shock		Suits OE Height LJ80 & 80V
BD1104T	2	35mm Nitro Gas Shock		Suits 50mm Lift LJ80 & 80V
<b>LEAF SPRINGS</b>				
T62	2	50mm Lift		
<b>COMPONENTS</b>				
TDUK-013	1	Urethane Shackle Bushing Kit		
TDUB-014	2	U-Bolt Kit		
TDGS-656	1	Greasable Shackle Kit		

### REPLACEMENT BUSHINGS

QUANTITY PER SHOCK				
TW959	2	Suits Top Front Pin Mount		Pin Style Bushing
404702	1	Suits Bottom Front Eying		Eying Bushing
404702	2	Suits Top & Bottom Rear Eying		Eying Bushing

### COMPLETE KIT PRICE REFERENCE

SHOCK CHOICE	SPRING CHOICE	RRP inc GST	CONTENTS
35mm Nitro Gas	50mm LIFT		
<p align="center"><b>Includes</b></p> <p align="center">4 x Leaf Springs      4 x Shocks 4 x U-Bolt Kits      2 x Shackle Bushing Kit</p>			

Vehicle fitment sheet must be completed when suspension fitted. Failure to do so may affect warranty.  
Fitment sheet can be found on page 200 of this catalogue



# SUZUKI

## VITARA

7/88-05

**INCLUDES GRAND VITARA & XL-7**

### FRONT SUSPENSION

**ESTIMATED LIFT: 30mm**

PART NO.	QTY	DESCRIPTION	RRP inc GST	NOTES
<b>SHOCK ABSORBERS</b>				
BDS4613	2	Mini Strut Replacement		OE Height
BDS4000LR	2	Mini Strut (Includes Camber Bolt)		30mm Lift
<b>COIL SPRINGS</b>				
TDC814	2	30mm Lift Spring		88-3/98 1.6L SWB
TDC816	2	30mm Lift Spring		88-3/98 2.0L SWB & 1.6L LWB
TDC818	2	30mm Lift Spring		95-3/98 2.0L V6 LWB
TDC834SL	2	30mm Lift Spring		98-05 1.6L, 2.0L SWB & LWB
TDC834	2	30mm Lift Spring		98-05 2.5L V6 LWB
TDC834H	2	30mm Lift Spring		01-05 2.7L V6
<b>STEERING DAMPER</b>				
SS5614-M/S	1	Return to Centre Damper		Manual Steering 7/88-02

### REAR SUSPENSION

<b>SHOCK ABSORBERS</b>				
BD1166T	2	35mm Nitro Gas Shock		Up to 30mm Lift
<b>COIL SPRINGS</b>				
TDC815	2	0-300kg Load		30mm Lift 88-3/98 SWB
TDC817	2	0-300kg Load		30mm Lift 91-3/98 LWB
TDC835SL	2	0-300kg Load		30mm Lift 4/98-7/05 SWB
TDC835	2	0-300kg Load		30mm Lift 4/98-7/05 LWB
TDC838	2	0-300kg Load		30mm 7/01-05 XL-7 ONLY

### REPLACEMENT BUSHINGS

QUANTITY PER SHOCK				
TW959	2	Suits Top Rear Pin Mount		Pin Style Bushing
4W-SPF420-02	1	Suits Rear Bottom Eye		Eye Style Bushing

### COMPLETE KIT PRICE REFERENCE

SHOCK CHOICE	SPRING CHOICE	RRP inc GST	CONTENTS
35mm Nitro Gas	30mm LIFT		
<p align="center"><b>Includes</b>            4 x Coil Springs    2 x Rear Shocks            2 x Front Struts</p>			

Freight should be added where required. When determining spring choice, include only permanent accessories & weights. Towing requirements are not included in constant load determination

# TOYOTA

## FORTUNER

04 - 12/15



### FRONT SUSPENSION

**ESTIMATED LIFT: 40mm**

PART NO.	QTY	DESCRIPTION	RRP inc GST	NOTES
<b>SHOCK ABSORBERS</b>				
FC404600	2	40mm Foam Cell Strut		
BM404600	2	40mm Adjustable Strut		9 Stage Adjustable
<b>COIL SPRINGS</b>				
TDC974S	2	OE Height Only		OE Replacement Only
TDC974	2	40mm Lift Spring		Petrol/Diesel/Bar
TDC974H	2	40mm Lift Spring		Petrol/Diesel/Bar/Winch
<b>COMPLETE STRUT ASSEMBLY</b>				
TOY-026/01	2	BM404600/TDC974		Petrol/Diesel/Bar
TOY-026/02	2	BM404600/TDC974H		Petrol/Diesel/Bar/Winch
TOY-026/03	2	FC404600/TDC974		Petrol/Diesel/Bar
TOY-026/04	2	FC404600/TDC974H		Petrol/Diesel/Bar/Winch
<b>REPLACEMENT STRUT ASSEMBLY</b>				
TOY-1083	2	Strut Top		Replacement Strut Top

### REAR SUSPENSION

<b>SHOCK ABSORBERS</b>				
FC41113	2	41mm Foam Cell Shock		Up to 40mm Lift
BM401113	2	40mm 9 Stage Adjustable		Up to 40mm Lift
<b>COIL SPRINGS</b>				
TDC912	2	0-300kg Load		40mm Lift
TDC912L	2	<b>CONSTANT</b> 300Kg Load		40mm Lift
TDC912HL	2	<b>CONSTANT</b> 500Kg Load		40mm Lift

### REPLACEMENT BUSHINGS

QUANTITY PER SHOCK				
TOY-1083	1	Replacement Strut Top		Available As Complete Unit Only
ADJ00300/40	1	Suits Bottom Front Eying		Eying Bonded Bushing
ADJ00191	1	Suits Rear Bottom Eying		Eying Bushing
TW959	2	Suits Rear Top Pin		Pin Style Bushing

Vehicle fitment sheet must be completed when suspension fitted. Failure to do so may affect warranty.  
Fitment sheet can be found on page 200 of this catalogue

# TOYOTA

## FORTUNER

04 - 12/15  
All Models

### COMPLETE KIT PRICE REFERENCE

SHOCK CHOICE	SPRING CHOICE	RRP inc GST	CONTENTS
<p><b>Foam Cell Struts Require Assembly</b></p> <p><u>Includes</u> 2x Front Struts 2x Rear Shocks 4x Coil Springs</p>	ANY		
<p><b>Foam Cell Complete Assembly Struts</b></p> <p><u>Includes</u> 2x Complete Struts 2x Rear Shocks 2x Coil Springs</p>	ANY		
<p><b>40mm Adjustable Struts Require Assembly</b></p> <p><u>Includes</u> 2x Front Struts 2x Rear Shocks 4x Coil Springs</p>	ANY		
<p><b>40mm Adjustable Complete Assembly Struts</b></p> <p><u>Includes</u> 2x Complete Struts 2x Rear Shocks 2x Coil Springs</p>	ANY		

Freight should be added where required. When determining spring choice, include only permanent accessories & weights. Towing requirements are not included in constant load determination

# TOYOTA

## FORTUNER

### 15 On



## FRONT SUSPENSION

**ESTIMATED LIFT: 40mm**

PART NO.	QTY	DESCRIPTION	RRP inc GST	NOTES
<b>SHOCK ABSORBERS</b>				
FC404600	2	40mm Foam Cell Strut		
BM404600	2	40mm Adjustable Strut		9 Stage Adjustable
<b>COIL SPRINGS</b>				
TDC974	2	40mm Lift Spring		Petrol/Diesel/No Bar
TDC983	2	40mm Lift Spring		Petrol/Diesel/Bar
TDC974H	2	40mm Lift Spring		Petrol/Diesel/Bar/Winch
<b>COMPLETE STRUT ASSEMBLY</b>				
TOY-026/01	2	BM404600/TDC974		Petrol/Diesel/No Bar
TOY-027/02	2	BM404600/TDC983		Petrol/Diesel/Bar
TOY-027/03	2	BM404600/TDC974H		Petrol/Diesel/Bar/Winch
TOY-026/03	2	FC404600/TDC974		Petrol/Diesel/No Bar
TOY-027/06	2	FC404600/TDC983		Petrol/Diesel/Bar
TOY-027/07	2	FC404600/TDC974H		Petrol/Diesel/Bar/Winch
<b>REPLACEMENT STRUT ASSEMBLY</b>				
TOY-1083	2	Strut Top		Replacement Strut Top

## REAR SUSPENSION

<b>SHOCK ABSORBERS</b>				
FC43016	2	41mm Foam Cell Shock		Up to 40mm Lift
BM403016	2	40mm 9 Stage Adjustable		Up to 40mm Lift
<b>COIL SPRINGS</b>				
TDC913L	2	0-300kg Load		40mm Lift
TDC913HL	2	<b>CONSTANT</b> 300Kg Load		40mm Lift
TDC913VHL	2	<b>CONSTANT</b> 500Kg Load		40mm Lift
<b>COMPONENTS</b>				
TDSP-010	1	Transmission Spacer Kit		Must be fitted with all lift kits
<b>AIR ASSIST BAGS</b>				
TDAA-003	1	Coil insert bag kit		Suits 40mm Lift

## REPLACEMENT BUSHINGS

QUANTITY PER SHOCK				
TOY-1083	1	Replacement Strut Top		Available As Complete Unit Only
ADJ00300/40	1	Suits Bottom Front Eying		Eying Bonded Bushing
415024	1	Suits Rear Bottom Eying		Eying Bushing





Vehicle fitment sheet must be completed when suspension fitted. Failure to do so may affect warranty.  
Fitment sheet can be found on page 200 of this catalogue

# TOYOTA

## FORTUNER

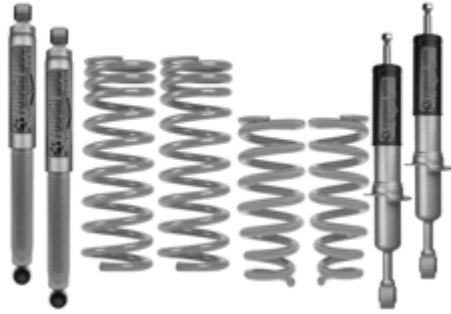
15 On  
All Models

### COMPLETE KIT PRICE REFERENCE

SHOCK CHOICE	SPRING CHOICE	RRP inc GST	CONTENTS
<p><b>Foam Cell Struts Require Assembly</b></p> <p><u>Includes</u> 2x Front Struts 2x Rear Shocks 4x Coil Springs 1x Transmission Spacer</p>	ANY		
<p><b>Foam Cell Complete Assembly Struts</b></p> <p><u>Includes</u> 2x Complete Struts 2x Rear Shocks 2x Coil Springs 1x Transmission Spacer</p>	ANY		
<p><b>40mm Adjustable Struts Require Assembly</b></p> <p><u>Includes</u> 2x Front Struts 2x Rear Shocks 4x Coil Springs 1x Transmission Spacer</p>	ANY		
<p><b>40mm Adjustable Complete Assembly Struts</b></p> <p><u>Includes</u> 2x Complete Struts 2x Rear Shocks 2x Coil Springs 1x Transmission Spacer</p>	ANY		

Freight should be added where required. When determining spring choice, include only permanent accessories & weights. Towing requirements are not included in constant load determination

# TOYOTA

## 4RUNNER

11/85-89

IFS WITH LEAF REAR



### FRONT SUSPENSION

**ESTIMATED LIFT: 50mm**

PART NO.	QTY	DESCRIPTION	RRP inc GST	NOTES
<b>SHOCK ABSORBERS</b>				
FC41127B	2	35mm Foam Cell Shock		Up to 50mm Lift
<b>TORSION BARS</b>				
4WTB-1646	1	Replacement Torsion Bars		26mm/1064mm
<b>Adjust Torsion bars after fitting shocks - Ensure a minimum of 60mm Droop is Maintained</b>				
<b>STEERING DAMPERS</b>				
EXT5510	1	H/D Replacement Damper		
S55510-P/S	1	Return to Centre Damper		

### REAR SUSPENSION

<b>SHOCK ABSORBERS</b>				
BD1350T	2	35mm Nitro Gas Shock		Suits OE Height
FC41350	2	41mm Foam Cell Shock		
BM401350	2	40mm 9 Stage Adjustable		
BD1377T	2	35mm Nitro Gas Shock		Suits 50mm Lift
FC41377	2	41mm Foam Cell Shock		
BM401377	2	40mm 9 Stage Adjustable		
<b>LEAF SPRINGS</b>				
T46C	2	0-300kg Load		50mm Lift
T46L	2	<b>CONSTANT</b> 300Kg Load		50mm Lift
<b>COMPONENTS</b>				
TDUK-015	1	Urethane Shackle Bushing Kit		
TDUB-016	2	U-Bolt Kit		
TDGP-385	1	Greasable Pin Kit		
TDGS-386	1	Greasable Shackle Kit		

### REPLACEMENT BUSHINGS

QUANTITY PER SHOCK				
TW959	1	Suits Front Top Pin		Pin Style Bushing
ADJ00191	1	Suits Top & Bottom Rear Eye		Eyering Bushing
TW038-16	1	Suits Front Bottom Eye		Eyering Bushing

### COMPLETE KIT PRICE REFERENCE

SHOCK CHOICE	SPRING CHOICE	RRP inc GST	CONTENTS
Foam Cell Front Nitro Gas Rear	T46C 0-300KG T46L <b>300KG+</b>		
41mm Foam Cell	T46C 0-300KG T46L <b>300KG+</b>		
Foam Cell Front Adjustable Rear	T46C 0-300KG T46L <b>300KG+</b>		

Vehicle fitment sheet must be completed when suspension fitted. Failure to do so may affect warranty.  
Fitment sheet can be found on page 200 of this catalogue





# TOYOTA

## 4RUNNER

89-96

### IFS WITH COIL REAR

## FRONT SUSPENSION

**ESTIMATED LIFT: 50mm**

PART NO.	QTY	DESCRIPTION	RRP inc GST	NOTES
<b>SHOCK ABSORBERS</b>				
FC41127B	2	35mm Foam Cell Shock		Up to 50mm Lift
<b>TORSION BARS</b>				
4WTB-1646	1	Replacement Torsion Bars		26mm/1064mm
<b>Adjust Torsion bars after fitting shocks - Ensure a minimum of 60mm Droop is Maintained</b>				
<b>STEERING DAMPERS</b>				
EXT5510	1	H/D Replacement Damper		
S55510-P/S	1	Return to Centre Damper		

## REAR SUSPENSION

<b>SHOCK ABSORBERS</b>				
FC41108	2	41mm Foam Cell Shock		Suits OE Height
BM401108	2	40mm 9 Stage Adjustable		
FC41113	2	41mm Foam Cell Shock		Suits 50mm Lift
BM401113	2	40mm 9 Stage Adjustable		
<b>COIL SPRINGS</b>				
TDC946S	2	0-300kg Load		OE Height
TDC946	2	0-300kg Load		50mm Lift
TDC946H	2	<b>CONSTANT</b> 300Kg Load		50mm Lift
<b>PANHARD ROD</b>				
TDPR-008	1	Adjustable Panhard Rod		

## REPLACEMENT BUSHINGS

QUANTITY PER SHOCK				
TW959	2	Suits Front Top Pin		Pin Style Bushing
TW959	2	Suits Rear Top Pin		Pin Style Bushing
ADJ00191	1	Suits Bottom Rear Eye		Eyering Bushing
TW038-16	1	Suits Front Bottom Eyering		Eyering Bushing

## COMPLETE KIT PRICE REFERENCE

SHOCK CHOICE	SPRING CHOICE	RRP inc GST	CONTENTS
41mm Foam Cell	ANY REAR COIL		
Foam Cell Front Adjustable Rear	ANY REAR COIL		
<b>Includes</b> 2 x Coil Springs      4 x Shocks			

Freight should be added where required. When determining spring choice, include only permanent accessories & weights. Towing requirements are not included in constant load determination

# TOYOTA

## HILUX

4/79-97

LEAF/LEAF 4WD



### FRONT SUSPENSION

**ESTIMATED LIFT: 50mm**

PART NO.	QTY	DESCRIPTION	RRP inc GST	NOTES
<b>SHOCK ABSORBERS</b>				
BD1134T	2	35mm Nitrogen Gas Shock		Suit OE Height
FC41134	2	41mm Foam Cell Shock		
BM401134	2	40mm 9 Stage Adjustable Shock		
BD1109T	2	35mm Nitrogen Gas		Suit 50mm Lift
FC41109	2	41mm Foam Cell Shock		
BM401109	2	40mm 9 Stage Adjustable		
<b>LEAF SPRINGS</b>				
T75	2	Petrol/Diesel/Bar		50mm Lift Spring
T78	2	Petrol/Diesel/Bar/Winch		50mm Lift Spring
<b>STEERING DAMPERS</b>				
EXT5500	1	H/D Replacement Damper		Suits Manual Steering Suits Power Steering
SS5500-M/S	1	Return to Centre Damper		
SS5500-P/S	1	Return to Centre Damper		
SV5500	1	9 Stage Adjustable Damper		
<b>COMPONENTS</b>				
TDUK-014	1	Urethane Shackle Bushing Kit		Suits D/S (1 Kit Req'd) Suits P/S (1 Kit Req'd)  Fit with all Lift Kits
TDUB-015	1	U-Bolt Kit		
TDUB-016	1	U-Bolt Kit		
TDGP-385	1	Greasable Pin Kit		
TDGS-384	1	Greasable Shackle Kit		
TDDL-001	1	Adjustable Diff Locator		

### FRONT END KIT PRICE REFERENCE

SHOCK CHOICE	SPRING CHOICE	RRP inc GST	CONTENTS
<b>35mm Nitro Gas</b>	T75		
	T78		
<b>41mm Foam Cell</b>	T75		
	T78		
<b>9 Stage Adjustable</b>	T75		
	T78		
<p align="center"><b>Includes</b></p> <p align="center">                     2 x Leaf Springs      2 x Shocks                      2 x U-Bolt Kits      1 x Urethane Kit      1 x Diff Locator                 </p>			

Vehicle fitment sheet must be completed when suspension fitted. Failure to do so may affect warranty.  
Fitment sheet can be found on page 200 of this catalogue

# TOYOTA

## HILUX

### 4/79-97

### LEAF/LEAF 4WD

## REAR SUSPENSION

PART NO.	QTY	DESCRIPTION	RRP inc GST	NOTES
<b>SHOCK ABSORBERS</b>				
BD1382T	2	35mm Nitrogen Gas Shock		Suits OE Height 4/79-83 Models
FC41382	2	41mm Foam Cell Shocks		
BM401382	2	40mm 9 Stage Adjustable Shock		
BD1388T	2	35mm Nitrogen Gas		Suits 50mm Lift 4/79-83 Models
BM401388	2	41mm Foam Cell Shocks		
BM401388	2	40mm 9 Stage Adjustable		
BD1350T	2	35mm Nitrogen Gas		Suits OE Height 11/83-97 Models
FC41350	2	41mm Foam Cell Shocks		
BM401350	2	40mm 9 Stage Adjustable		
BD1377T	2	35mm Nitrogen Gas		Suits 50mm Lift 11/83-97 Models
FC41377	2	41mm Foam Cell Shocks		
BM401377	2	40mm 9 Stage Adjustable		
<b>LEAF SPRINGS</b>				
T46C	2	0-300Kg Load		50mm Lift Spring
T46L	2	<b>CONSTANT</b> 300Kg Load		50mm Lift Spring
BP-002XHD	2	<b>CONSTANT</b> 500Kg Load		50mm Lift Spring
<b>COMPONENTS</b>				
TDUK-015	1	Urethane Shackle Bushing Kit		
TDUB-016	2	U-Bolt Kit		
TDGP-385	1	Greasable Pin Kit		
TDGS-386	1	Greasable Shackle Kit		

## REAR END KIT PRICE REFERENCE

SHOCK CHOICE	SPRING CHOICE	RRP inc GST	CONTENTS
<b>35mm Nitro Gas</b>	T46C T46L BP-002XHD		
<b>41mm Foam Cell</b>	T46C T46L BP-002XHD		
<b>9 Stage Adjustable</b>	T46C T46L BP-002XHD		
<b>Includes</b> 2 x Leaf Springs    2 x Shocks 2 x U-Bolt Kits    1 x Urethane Kit			

Freight should be added where required. When determining spring choice, include only permanent accessories & weights. Towing requirements are not included in constant load determination

# TOYOTA

## HILUX

10/88-97

### TORSION BAR FRONT



## FRONT SUSPENSION

**ESTIMATED LIFT: 50mm**

PART NO.	QTY	DESCRIPTION	RRP inc GST	NOTES
<b>SHOCK ABSORBERS</b>				
FC41127B	2	35mm Foam Cell Shock		Up to 50mm Lift
<b>TORSION BARS</b>				
4WTB-1646	1	Replacement Torsion Bars		26mm/1064mm
<b>Adjust Torsion bars after fitting shocks - Ensure a minimum of 60mm Droop is Maintained</b>				
<b>STEERING DAMPERS</b>				
EXT5510	1	H/D Replacement Damper		
SS5510-P/S	1	Return to Centre Damper		

## REAR SUSPENSION

<b>SHOCK ABSORBERS</b>				
BD1350T	2	35mm Nitro Gas Shock		Suits OE Height
FC41350	2	41mm Foam Cell Shock		
BM401350	2	40mm 9 Stage Adjustable		
BD1377T	2	35mm Nitro Gas Shock		Suits 50mm Lift
FC41377	2	41mm Foam Cell Shock		
BM401377	2	40mm 9 Stage Adjustable		
<b>LEAF SPRINGS</b>				
BP-007	2	0-300kg Load		50mm Lift
BP-007H	2	<b>CONSTANT</b> 300Kg Load		50mm Lift
BP-007HH	2	<b>CONSTANT</b> 500Kg Load		50mm Lift
<b>COMPONENTS</b>				
TDUK-037	1	Urethane Shackle Bushing Kit		
TDUB-016	2	U-Bolt Kit		
TDGS-386/1	1	Greasable Shackle Kit		
TDGP-668	1	Greasable Pin Kit		

## REPLACEMENT BUSHINGS

QUANTITY PER SHOCK				
TW959	2	Suits Front Top Pin		Pin Style Bushing
TW038-16	1	Suits Front Bottom Eye		Eyering Bushing
ADJ00191	2	Suits Top & Bottom Rear Eye		Eyering Bushing

Vehicle fitment sheet must be completed when suspension fitted. Failure to do so may affect warranty.  
Fitment sheet can be found on page 200 of this catalogue



# TOYOTA

## HILUX

10/88-97

### TORSION BAR FRONT

## COMPLETE KIT PRICE REFERENCE

SHOCK CHOICE	SPRING CHOICE	RRP inc GST	CONTENTS
<p><b>Foam Cell Front Nitro gas Rear</b></p> <p><u>Includes</u>            2 x Leaf Springs            4 x Shocks            2 x U-Bolt Kits            1 x Urethane Kit</p>	<p>BP-007 0-300KG</p> <p>BP-007H CONSTANT 300KG</p> <p>BP-007HH CONSTANT 500KG</p>		
<p><b>41mm Foam Cell</b></p> <p><u>Includes</u>            2 x Leaf Springs            4 x Shocks            2 x U-Bolt Kits            1 x Urethane Kit</p>	<p>BP-007 0-300KG</p> <p>BP-007H CONSTANT 300KG</p> <p>BP-007HH CONSTANT 500KG</p>		
<p><b>Foam Cell Front Adjustable Rear</b></p> <p><u>Includes</u>            2 x Leaf Springs            4 x Shocks            2 x U-Bolt Kits            1 x Urethane Kit</p>	<p>BP-007 0-300KG</p> <p>BP-007H CONSTANT 300KG</p> <p>BP-007HH CONSTANT 500KG</p>		

Freight should be added where required. When determining spring choice, include only permanent accessories & weights. Towing requirements are not included in constant load determination

# TOYOTA

## HILUX

10/97-05

### TORSION BAR FRONT



## FRONT SUSPENSION

**ESTIMATED LIFT: 50mm**

PART NO.	QTY	DESCRIPTION	RRP inc GST	NOTES
<b>SHOCK ABSORBERS</b>				
FC41127B	2	41mm Foam Cell Shock		Up to 50mm Lift
<b>TORSION BARS</b>				
4WTB-1646	1	Replacement Torsion Bars		26mm/1064mm
<b>Adjust Torsion bars after fitting shocks - Ensure a minimum of 60mm Droop is Maintained</b>				
<b>STEERING DAMPERS</b>				
EXT5510	1	H/D Replacement Damper		
SS5513-P/S	1	Return to Centre Damper		
SV5513	1	9 Stage Adjustable Damper		

## REAR SUSPENSION

<b>SHOCK ABSORBERS</b>				
<b>Please take note of shock application for standard and lifted height vehicles</b>				
BD1350T <b>(D/S)</b>	1	35mm Nitro Gas Shock		<b>Suits OE Height</b>
BD1377T <b>(P/S)</b>	1	35mm Nitro Gas Shock		
FC41350 <b>(D/S)</b>	1	41mm Foam Cell Shock		
FC41377 <b>(P/S)</b>	1	41mm Foam Cell Shock		
BM401350 <b>(D/S)</b>	1	40mm 9 Stage Adjustable		
BM401377 <b>(P/S)</b>	1	40mm 9 Stage Adjustable		
BD1377T	2	35mm Nitro Gas Shock		<b>Suits 50mm Lift</b>
FC41377	2	41mm Foam Cell Shock		
BM401377	2	40mm 9 Stage Adjustable		
<b>LEAF SPRINGS</b>				
T79C	2	0-300kg Load		50mm Lift
T79L	2	<b>CONSTANT</b> 300Kg Load		50mm Lift
T79LL	2	<b>CONSTANT</b> 500Kg Load		50mm Lift
<b>COMPONENTS</b>				
TDUK-038	1	Urethane Shackle Bushing Kit		
TDUB-016	2	U-Bolt Kit		
TDGS-386/1	1	Greasable Shackle Kit		
TDGP-668	1	Greasable Pin Kit		

## REPLACEMENT BUSHINGS

QUANTITY PER SHOCK				
TW959	2	Suits Front Top Pin		Pin Style Bushing
ADJ00191	2	Suits Top & Bottom Rear Eye		Eyering Bushing
TW038-16	1	Suits Front Bottom Eye		Eyering Bushing

Vehicle fitment sheet must be completed when suspension fitted. Failure to do so may affect warranty.  
Fitment sheet can be found on page 200 of this catalogue



# TOYOTA

## HILUX

10/97-05

### TORSION BAR FRONT

## COMPLETE KIT PRICE REFERENCE

SHOCK CHOICE	SPRING CHOICE	RRP inc GST	CONTENTS
<p><b>Foam Cell Front Nitro gas Rear</b></p> <p><u>Includes</u> 2 x Leaf Springs 4 x Shocks 2 x U-Bolt Kits 1 x Urethane Kit</p>	<p>T79C 0-300KG</p> <p>T79L CONSTANT 300KG</p> <p>T79LL CONSTANT 500KG</p>		
<p><b>41mm Foam Cell</b></p> <p><u>Includes</u> 2 x Leaf Springs 4 x Shocks 2 x U-Bolt Kits 1 x Urethane Kit</p>	<p>T79C 0-300KG</p> <p>T79L CONSTANT 300KG</p> <p>T79LL CONSTANT 500KG</p>		
<p><b>Foam Cell Front Adjustable Rear</b></p> <p><u>Includes</u> 2 x Leaf Springs 4 x Shocks 2 x U-Bolt Kits 1 x Urethane Kit</p>	<p>T79C 0-300KG</p> <p>T79L CONSTANT 300KG</p> <p>T79LL CONSTANT 500KG</p>		

Freight should be added where required. When determining spring choice, include only permanent accessories & weights. Towing requirements are not included in constant load determination

# TOYOTA

## HILUX

4/05-15

KUN26R (COIL/LEAF)



### FRONT SUSPENSION

ESTIMATED LIFT: 40mm

PART NO.	QTY	DESCRIPTION	RRP inc GST	NOTES
<b>SHOCK ABSORBERS</b>				
FC404600	2	40mm Foam Cell Strut		
BM404600	2	40mm Adjustable Strut		9 Stage Adjustable
<b>COIL SPRINGS</b>				
TDC974S	2	OE Height Only		OE Replacement Only
TDC974	2	40mm Lift Spring		Petrol/Diesel/Bar
TDC974H	2	40mm Lift Spring		Petrol/Diesel/Bar/Winch
<b>COMPLETE STRUT ASSEMBLY</b>				
TOY-026/01	2	BM404600/TDC974		Petrol/Diesel/Bar
TOY-026/02	2	BM404600/TDC974H		Petrol/Diesel/Bar/Winch
TOY-026/03	2	FC404600/TDC974		Petrol/Diesel/Bar
TOY-026/04	2	FC404600/TDC974H		Petrol/Diesel/Bar/Winch
<b>REPLACEMENT STRUT TOP</b>				
TOY-1083	2	Strut Top		Replacement Strut Top
<b>COMPONENTS</b>				
TDSP-011	1	Sway Bar Spacer Kit		76mm hole spacing

### REAR SUSPENSION

<b>SHOCK ABSORBERS</b>				
FC41350	2	41mm Foam Cell Shock		<b>SUITS OE HEIGHT ONLY!!</b>
BM401350	2	40mm Adjustable Shock		
FC41376	2	41mm Foam Cell Shock		<b>SUITS 40MM LIFT ONLY!!</b>
BM401376	2	40mm Adjustable Shock		
<b>LEAF SPRINGS</b>				
T80C	2	0-300KG Load		40mm Lift
T80L	2	<b>CONSTANT</b> 300Kg Load		40mm Lift
T80LL	2	<b>CONSTANT</b> 500Kg Load		40mm Lift
<b>FIT CONSTANT LEAVES ONLY WHERE CONSTANT LOAD FITTED - PREMATURE FAILURE MAY OCCUR</b>				
<b>COMPONENTS</b>				
TDUK-067	1	Urethane Bushing Kit		
TDUB-016	2	U-Bolt Kit		
TDGS-389	1	Greasable Shackle Kit		
TDGP-668	1	Greasable Pin Kit		
<b>AIR ASSIST BAGS</b>				
TDAA-112	1	Bellows bag kit		Suits 40mm Lift

### REPLACEMENT BUSHINGS

<b>SHOCK ABSORBERS</b>				
TOY-1083	1	Top Front Replacement Assembly		Bushes not sold separately
ADJ00300/40	1	Bottom Front Eying		Bonded eyering bushing
ADJ00191	2	Top & Bottom Rear Eying		Eyering Bushing

Vehicle fitment sheet must be completed when suspension fitted. Failure to do so may affect warranty.

Fitment sheet can be found on page 200 of this catalogue







# TOYOTA

## HILUX

4/05-15  
KUN26R (COIL/LEAF)

### COMPLETE KIT PRICE REFERENCE

SHOCK CHOICE	SPRING CHOICE	RRP inc GST	CONTENTS
<p><b>Foam Cell Struts Require Assembly</b></p> <p><u>Includes</u>            2 x Coil Springs            4 x Shocks            2 x Leaf Springs            2 x U-Bolt Kits            1 x Urethane Kit</p>	<p>T80C 0-300KG</p> <p>T80L CONSTANT 300KG</p> <p>T80LL CONSTANT 500KG</p>		
<p><b>Foam Cell Complete Assembly Struts</b></p> <p><u>Includes</u>            2 x Complete Struts            2 x Shocks            2 x Leaf Springs            2 x U-Bolt Kits            1 x Urethane Kit</p>	<p>T80C 0-300KG</p> <p>T80L CONSTANT 300KG</p> <p>T80LL CONSTANT 500KG</p>		
<p><b>40mm Adjustable Struts Require Assembly</b></p> <p><u>Includes</u>            2 x Coil Springs            4 x Shocks            2 x Leaf Springs            2 x U-Bolt Kits            1 x Urethane Kit</p>	<p>T80C 0-300KG</p> <p>T80L CONSTANT 300KG</p> <p>T80LL CONSTANT 500KG</p>		
<p><b>40mm Adjustable Complete Assembly Struts</b></p> <p><u>Includes</u>            2 x Complete Struts            2 x Shocks            2 x Leaf Springs            2 x U-Bolt Kits            1 x Urethane Kit</p>	<p>T80C 0-300KG</p> <p>T80L CONSTANT 300KG</p> <p>T80LL CONSTANT 500KG</p>		

Freight should be added where required. When determining spring choice, include only permanent accessories & weights. Towing requirements are not included in constant load determination

# TOYOTA

## HILUX

4/05-15

KUN26R - MINING APPLICATIONS



### FRONT SUSPENSION

**ESTIMATED LIFT: 40mm**

PART NO.	QTY	DESCRIPTION	RRP inc GST	NOTES
<b>SHOCK ABSORBERS</b>				
FC404600	2	41mm Foam Cell Strut		
<b>COIL SPRINGS</b>				
TDC976	2	40mm Lift Spring		Petrol/Diesel/Bar/Winch
<b>COMPLETE STRUT ASSEMBLY</b>				
TOY-026/05	2	FC404600/TDC976		Petrol/Diesel/Bar/Winch
<b>REPLACEMENT STRUT TOP</b>				
TOY-1083	2	Strut Top		Replacement Strut Top
<b>COMPONENTS</b>				
TDSP-011	1	Sway Bar Spacer Kit		76mm hole spacing

### REAR SUSPENSION

<b>SHOCK ABSORBERS</b>				
FC41350	2	41mm Foam Cell Shock		<b>SUITS OE HEIGHT ONLY!!</b>
FC41376	2	41mm Foam Cell Shock		<b>SUITS 0MM LIFT ONLY!!</b>
<b>LEAF SPRINGS</b>				
T80LL	2	500KG <b>CONSTANT</b> Load		40mm Lift
<b>FIT CONSTANT LEAVES ONLY WHERE CONSTANT LOAD FITTED - PREMATURE FAILURE MAY OCCUR</b>				
<b>COMPONENTS</b>				
TDUK-067	1	Urethane Bushing Kit		
TDUB-016	2	U-Bolt Kit		
TDGS-389	1	Greasable Shackles Kit		
TDGP-668	1	Greasable Pin Kit		
<b>AIR ASSIST BAGS</b>				
TDAA-112	1	Bellows bag kit		Suits 40mm Lift

### REPLACEMENT BUSHINGS

<b>SHOCK ABSORBERS</b>				
TOY-1083	1	Top Front Replacement Assembly		Bushes not sold separately
ADJ00300/40	1	Bottom Front Eying		Bonded eyering bushing
ADJ00191	2	Top & Bottom Rear Eying		Eyering Bushing

### MINE SPEC APPLICATIONS PLEASE

#### NOTE:

**Please always be aware of the GVM of the vehicle when selecting a suspension kit.**

**Kerb Weight - 1765-1815kg**



**GVM - 2810kg**

**Maximum Load - 995-1045 (model dependent)**

Vehicle fitment sheet must be completed when suspension fitted. Failure to do so may affect warranty.

Fitment sheet can be found on page 200 of this catalogue

## COMPLETE KIT PRICE REFERENCE

SHOCK CHOICE	SPRING CHOICE	RRP inc GST	CONTENTS
<p><b>41mm Foam Cell Struts Require Assembly</b></p> <p><b>Includes</b>                      2 x Coil Springs                      4 x Shocks                      2 x Leaf Springs                      2 x U-Bolt Kits                      1 x Urethane Kit</p>	<p>T80LL                      CONSTANT 500KG</p>		
<p><b>41mm Foam Cell Complete Assembly Struts</b></p> <p><b>Includes</b>                      2 x Complete Struts                      2 x Shocks                      2 x Leaf Springs                      2 x U-Bolt Kits                      1 x Urethane Kit</p>	<p>T80LL                      CONSTANT 500KG</p>		

### When Selecting Mining Applications:

Carrying loads above the GVM in the tray of the vehicle will result in the following problems

- The Rear of the vehicle will drop down and the front ride height will increase.
- The struts will be riding at near full extension at all times
- When the vehicle is driven in this condition, the strut will top out (reach full extension) repeatedly.
- This leads to leakages and will eventually break the lower eye bush ring from the shock body.

With a 16" Rim fitted to the vehicle, the rim to guard ride height must not exceed **780mm as an Absolute Maximum**

#### Please Note:

Mining Spec Trays are often significantly heavier than traditional trays, and can weigh in excess of 500kg by themselves.

When fitted to the vehicle, the remaining carrying capacity (GVM minus Vehicle Weight) is 500kg. When additional permanent loads are taken into account, there may be very little carrying capacity available in the vehicle.

#### Extra items to consider include:

1. Personnel
2. Tools & Tool Boxes
3. Vehicle Fuel
4. Front mounted accessories (Bar/Winch/Dual battery)
5. R.O.P.S

**Please Call 4Way Suspension on (02) 9672 8899 for specialist assistance when selecting components for mining vehicle applications.**

*Freight should be added where required. When determining spring choice, include only permanent accessories & weights. Towing requirements are not included in constant load determination*

# TOYOTA

## HILUX

15 On

AN120/130 (COIL/LEAF)



### FRONT SUSPENSION

**ESTIMATED LIFT: 40mm**

PART NO.	QTY	DESCRIPTION	RRP inc GST	NOTES
<b>SHOCK ABSORBERS</b>				
FC404600	2	40mm Foam Cell Strut		
BM404600	2	40mm Adjustable Strut		9 Stage Adjustable
<b>COIL SPRINGS</b>				
TDC983S	2	OE Height Only		OE Replacement Only
TDC983	2	40mm Lift Spring		Petrol/Diesel/No bar
TDC974H	2	40mm Lift Spring		Petrol/Diesel/Bar
TDC974HH	2	40mm Lift Spring		Petrol/Diesel/Bar/Winch
<b>COMPLETE STRUT ASSEMBLY</b>				
TOY-027/01	2	BM404600/TDC983S		OE Replacement Only
TOY-027/02	2	BM404600/TDC983		Petrol/Diesel/No bar
TOY-027/03	2	BM404600/TDC974H		Petrol/Diesel/Bar
TOY-027/04	2	BM404600/TDC974HH		Petrol/Diesel/Bar/Winch
TOY-027/05	2	FC404600/TDC983S		OE Replacement Only
TOY-027/06	2	FC404600/TDC983		Petrol/Diesel/No bar
TOY-027/07	2	FC404600/TDC974H		Petrol/Diesel/Bar
TOY-027/08	2	FC404600/TDC974HH		Petrol/Diesel/Bar/Winch
<b>REPLACEMENT STRUT TOP</b>				
TOY-1083	2	Strut Top		Replacement Strut Top

### REAR SUSPENSION

<b>SHOCK ABSORBERS</b>				
FC43014	2	41mm Foam Cell Shock		
BM403014	2	40mm Adjustable Shock		Suit OE Height
BD3015T	2	35mm Nitro Gas Shock		<b>Fit for Comfort Applications</b>
FC43015	2	41mm Foam Cell Shock		
BM403015	2	40mm Adjustable Shock		Suit 40mm Lift
<b>LEAF SPRINGS - FIT CONSTANT LEAVES ONLY FOR CONSTANT LOAD FITTED - FAILURE MAY OCCUR</b>				
T81C	2	0-300KG Load		40mm Lift
T81L	2	<b>CONSTANT</b> 300Kg Load		40mm Lift
T81LL	2	<b>CONSTANT</b> 500Kg Load		40mm Lift
<b>COMPONENTS</b>				
TDUK-067	1	Urethane Bushing Kit		
TDUB-016	2	U-Bolt Kit		
TDGS-392	1	Greasable Shackle Kit		
TDGP-668	1	Greasable Pin Kit		
<b>AIR ASSIST BAGS</b>				
TDAA-113	1	Bellows bag kit		Suits 40mm Lift

### Replacement Bushings - see p148

Vehicle fitment sheet must be completed when suspension fitted. Failure to do so may affect warranty.  
Fitment sheet can be found on page 200 of this catalogue

**Note: Leaf spring front eye bolt & Headlight leveling sensor fitting instructions available at [toughdog.com.au](http://toughdog.com.au)**

# TOYOTA

## HILUX

15 On

AN120/130 (COIL/LEAF)

### COMPLETE KIT PRICE REFERENCE

SHOCK CHOICE	SPRING CHOICE	RRP inc GST	CONTENTS
<p><b>Foam Cell Struts Require Assembly</b></p> <p><u>Includes</u>            2 x Coil Springs            4 x Shocks            2 x Leaf Springs            2 x U-Bolt Kits            1 x Urethane Kit</p>	<p>T81C 0-300KG</p> <p>T81L CONSTANT 300KG</p> <p>T81LL CONSTANT 500KG</p>		
<p><b>Foam Cell Complete Assembly Struts</b></p> <p><u>Includes</u>            2 x Complete Struts            2 x Shocks            2 x Leaf Springs            2 x U-Bolt Kits            1 x Urethane Kit</p>	<p>T81C 0-300KG</p> <p>T81L CONSTANT 300KG</p> <p>T81LL CONSTANT 500KG</p>		
<p><b>40mm Adjustable Struts Require Assembly</b></p> <p><u>Includes</u>            2 x Coil Springs            4 x Shocks            2 x Leaf Springs            2 x U-Bolt Kits            1 x Urethane Kit</p>	<p>T81C 0-300KG</p> <p>T81L CONSTANT 300KG</p> <p>T81LL CONSTANT 500KG</p>		
<p><b>40mm Adjustable Complete Assembly Struts</b></p> <p><u>Includes</u>            2 x Complete Struts            2 x Shocks            2 x Leaf Springs            2 x U-Bolt Kits            1 x Urethane Kit</p>	<p>T81C 0-300KG</p> <p>T81L CONSTANT 300KG</p> <p>T81LL CONSTANT 500KG</p>		

Freight should be added where required. When determining spring choice, include only permanent accessories & weights. Towing requirements are not included in constant load determination

# TOYOTA

## LANDCRUISER

12/77-84  
40, 42 SERIES



### FRONT SUSPENSION

**ESTIMATED LIFT: 50mm**

PART NO.	QTY	DESCRIPTION	RRP inc GST	NOTES
<b>SHOCK ABSORBERS</b>				
FC41364	2	41mm Foam Cell Shocks		Suit OE Height
BM401364	2	40mm 9 Stage Adjustable Shock		
FC41366	2	41mm Foam Cell Shocks		Suit 50mm Lift
BM401366	2	40mm 9 Stage Adjustable		
<b>LEAF SPRINGS - Check Eye Size Prior to Ordering</b>				
BP-009	2	50mm Lift Spring - 25mm Eying		Petrol/Diesel/Bar
BP-009H	2	50mm Lift Spring - 25mm Eying		Petrol/Diesel/Bar/Winch
BP-011	2	50mm Lift Spring - 35mm Eying		Petrol/Diesel/Bar
BP-011H	2	50mm Lift Spring - 35mm Eying		Petrol/Diesel/Bar/Winch
<b>STEERING STABILIZERS</b>				
EXT5511	1	H/Duty Replacement Damper		
SS5511-M/S	1	Return to Centre Damper		Suits Manual Steering
SS5511-P/S	1	Return to Centre Damper		Suits Power Steering
<b>COMPONENTS</b>				
TDUK-016	1	Urethane Shackle Bushing Kit		Suits 25mm Eye Springs
TDUK-012	1	Urethane Shackle Bushing Kit		Suits 35mm Eye Springs
TDUB-017	2	U-Bolt Kit		
TDGP-346	1	Greasable pins		Suits 25mm Eye Springs
TDGS-343	1	Greasable Shackles		Suits 25mm Eye Springs
TDGP-351	1	Greasable pins		Suits 35mm Eye Springs
TDGS-348	1	Greasable Shackles		Suits 35mm Eye Springs

### REPLACEMENT BUSHINGS

<b>QUANTITY PER SHOCK</b>				
404702	2	Suits Front Top & bottom Eye		Eying Bushing
404702	2	Suits Rear Top & bottom Eye		Eying Bushing

Vehicle fitment sheet must be completed when suspension fitted. Failure to do so may affect warranty.  
Fitment sheet can be found on page 200 of this catalogue



**KIT PRICING REFERENCE  
COMPONENTS AS PER IMAGE**  
*please order using part numbers*

**TOYOTA**  
**LANDCRUISER**  
12/77-84  
40, 42 SERIES

**REAR SUSPENSION**

PART NO.	QTY	DESCRIPTION	RRP inc GST	NOTES
<b>SHOCK ABSORBERS</b>				
FC41366	2	41mm Foam Cell Shocks		Suit OE Height FJ40 59-84 To Chassis # 191114
BM401366	2	40mm 9 Stage Adjustable Shock		
FC41382	2	41mm Foam Cell Shocks		Suit 50mm Lift FJ40 59-84 To Chassis # 191114
BM401382	2	40mm 9 Stage Adjustable		
FC41382	2	41mm Foam Cell Shocks		Suit OE Height BJ40 12/77-80 & BJ42 - Chassis 191115 On
BM401382	2	40mm 9 Stage Adjustable Shock		
FC41388	2	41mm Foam Cell Shocks		Suit 50mm Lift BJ40 12/77-80 & BJ42 - Chassis 191115 On
BM401388	2	40mm 9 Stage Adjustable		
<b>LEAF SPRINGS - Check Eye Size Prior to Ordering</b>				
BP-010	2	50mm Lift Spring - 25mm Eying		0-300kg Load
BP-010H	2	50mm Lift Spring - 25mm Eying		<b>CONSTANT</b> 300Kg Load
BP-012	2	50mm Lift Spring - 35mm Eying		0-300kg Load
BP-012H	2	50mm Lift Spring - 35mm Eying		<b>CONSTANT</b> 300Kg Load
<b>COMPONENTS</b>				
TDUK-016	1	Urethane Shackle Bushing Kit		Suits 25mm Eye Springs
TDUK-012	1	Urethane Shackle Bushing Kit		Suits 35mm Eye Springs
TDUB-017	2	U-Bolt Kit		
TDGP-346	1	Greasable pins		Suits 25mm Eye Springs
TDGS-343	1	Greasable Shackles		Suits 25mm Eye Springs
TDGP-351	1	Greasable pins		Suits 35mm Eye Springs
TDGS-348	1	Greasable Shackles		Suits 35mm Eye Springs

**COMPLETE KIT PRICE REFERENCE**

SHOCK CHOICE	SPRING CHOICE	RRP inc GST	CONTENTS
41mm Foam Cell	BP-009 + BP-010		
	BP-009H+BP-010H		
	BP-011+BP012		
	BP-011H+BP-012H		
40mm 9 Stage Adjustable	BP-009 + BP-010		
	BP-009H+BP-010H		
	BP-011+BP012		
	BP-011H+BP-012H		
<p align="center"><b>Includes</b></p> <p align="center">4 x Leaf Springs      4 x Shocks 2 x Urethane Kits      4 x U-Bolt Kits</p>			
<p align="center"><b>Please Check Eye Size Prior to Ordering No Exchange for Special Order Parts</b></p>			

*Freight should be added where required. When determining spring choice, include only permanent accessories & weights. Towing requirements are not included in constant load determination*

# TOYOTA

## LANDCRUISER

1/65-84  
45, 47 SERIES



### FRONT SUSPENSION

**ESTIMATED LIFT: 50mm**

PART NO.	QTY	DESCRIPTION	RRP inc GST	NOTES
<b>SHOCK ABSORBERS</b>				
FC41364	2	41mm Foam Cell Shocks		Suit OE Height
BM401364	2	40mm 9 Stage Adjustable Shock		
FC41366	2	41mm Foam Cell Shocks		Suit 50mm Lift
BM401366	2	40mm 9 Stage Adjustable		
<b>LEAF SPRINGS - Check Eye Size Prior to Ordering</b>				
BP-013 (45 SERIES)	2	50mm Lift Spring - 25mm Eying		Petrol/Diesel/Bar
BP-013H (45 SERIES)	2	50mm Lift Spring - 25mm Eying		Petrol/Diesel/Bar/Winch
BP-015 (47 SERIES)	2	50mm Lift Spring - 35mm Eying		Petrol/Diesel/Bar
BP-015H (47 SERIES)	2	50mm Lift Spring - 35mm Eying		Petrol/Diesel/Bar/Winch
<b>STEERING STABILIZERS</b>				
EXT5511	1	H/Duty Replacement Damper		
SS5511-M/S	1	Return to Centre Damper		Suits Manual Steering
SS5511-P/S	1	Return to Centre Damper		Suits Power Steering
<b>COMPONENTS</b>				
TDUK-016	1	Urethane Shackle Bushing Kit		Suits 25mm Eye Springs
TDUK-012	1	Urethane Shackle Bushing Kit		Suits 35mm Eye Springs
TDUB-017	1	U-Bolt Kit		
TDUB-018	1	U-Bolt Kit		
TDGP-346	1	Greasable pins		Suits 25mm Eye Springs
TDGS-343	1	Greasable Shackles		Suits 25mm Eye Springs
TDGP-351	1	Greasable pins		Suits 35mm Eye Springs
TDGS-348	1	Greasable Shackles		Suits 35mm Eye Springs

### REPLACEMENT BUSHINGS

QUANTITY PER SHOCK				
404702	2	Suits Front Top & bottom Eye		Eying Bushing
404702	2	Suits Rear Top & bottom Eye		Eying Bushing

Vehicle fitment sheet must be completed when suspension fitted. Failure to do so may affect warranty.  
Fitment sheet can be found on page 200 of this catalogue



**KIT PRICING REFERENCE  
COMPONENTS AS PER IMAGE**  
*please order using part numbers*

**TOYOTA**  
**LANDCRUISER**  
1/65-84  
**45, 47 SERIES**

**REAR SUSPENSION**

PART NO.	QTY	DESCRIPTION	RRP inc GST	NOTES
<b>SHOCK ABSORBERS</b>				
FC41382	2	41mm Foam Cell Shocks		Suit OE Height
BM401382	2	40mm 9 Stage Adjustable Shock		
FC41388	2	41mm Foam Cell Shocks		Suit 50mm Lift
BM401388	2	40mm 9 Stage Adjustable		
<b>LEAF SPRINGS - Check Eye Size Prior to Ordering</b>				
BP-014 (45 SERIES)	2	50mm Lift Spring - 30mm Eying		0-300kg Load
BP-014H (45 SERIES)	2	50mm Lift Spring - 30mm Eying		<b>CONSTANT</b> 300Kg Load
BP-016 (47 SERIES)	2	50mm Lift Spring - 35mm Eying		0-300kg Load
BP-016H (47 SERIES)	2	50mm Lift Spring - 35mm Eying		<b>CONSTANT</b> 300Kg Load
<b>COMPONENTS</b>				
TDUK-017	1	Urethane Shackle Bushing Kit		Suits 30mm Eye Springs
TDUK-012	1	Urethane Shackle Bushing Kit		Suits 35mm Eye Springs
TDUB-017	2	U-Bolt Kit		
TDGP-347	1	Greasable pins		Suits 30mm Eye Springs
TDGS-344/5	1	Greasable Shackles		Suits 30mm Eye Springs
TDGP-351	1	Greasable pins		Suits 35mm Eye Springs
TDGS-349/5	1	Greasable Shackles		Suits 35mm Eye Springs

**COMPLETE KIT PRICE REFERENCE**

SHOCK CHOICE	SPRING CHOICE	RRP inc GST	CONTENTS
41mm Foam Cell	BP-013 + BP-014		
	BP-013H+BP-014H		
BP-015+BP016			
BP-015H+BP-016H			
40mm 9 Stage Adjustable	BP-013 + BP-014		
	BP-013H+BP-014H		
	BP-015+BP016		
BP-015H+BP-016H			
<b>Includes</b> 4 x Leaf Springs      4 x Shocks 2 x Urethane Kits      4 x U-Bolt Kits			
<b>Please Check Eye Size Prior to Ordering No Exchange for Special Order Parts</b>			

Freight should be added where required. When determining spring choice, include only permanent accessories & weights. Towing requirements are not included in constant load determination

# TOYOTA

## LANDCRUISER

11/80-91  
60, 61, 62 SERIES



### FRONT SUSPENSION

**ESTIMATED LIFT: 50mm**

PART NO.	QTY	DESCRIPTION	RRP inc GST	NOTES
<b>SHOCK ABSORBERS</b>				
FC41113	2	41mm Foam Cell Shocks		Suit OE Height
BM401113	2	40mm 9 Stage Adjustable Shock		
FC41163	2	41mm Foam Cell Shocks		Suit 50mm Lift
BM401163	2	40mm 9 Stage Adjustable		
<b>LEAF SPRINGS</b>				
T43L	2	50mm Lift Spring		Petrol/Diesel/Bar
T43H	2	50mm Lift Spring		Petrol/Diesel/Bar/Winch
T53	2	50mm Lift Spring (T/Diesel ONLY)		Factory T.Diesel/Bar
T53H	2	50mm Lift Spring (T/Diesel ONLY)		Factory T.Diesel/Bar/Winch
<b>STEERING STABILIZERS</b>				
EXT5001	1	H/Duty Replacement Damper		Suits Power Steering
SS5001-P/S	1	Return to Centre Damper		
SV5001	1	9 Stage Adjustable Dampers		
<b>COMPONENTS</b>				
TDUK-012	1	Urethane Shackle Bushing Kit		
TDUB-019	2	U-Bolt Kit		
TDGP-351	1	Greasable pins		
TDGS-348	1	Greasable Shackles		
TAK-005	1	Offset King Pin		0.5 Degree
TAK-075	1	Offset King Pin		0.75 Degree
TAK-001	1	Offset King Pin		1.0 Degree

### FRONT END KIT PRICE REFERENCE

SHOCK CHOICE	SPRING CHOICE	RRP inc GST	CONTENTS
41mm Foam Cell	T43L		
	T43H		
	T53		
	T53H		
40mm 9 Stage Adjustable	T43L		
	T43H		
	T53		
	T53H		
<p align="center"><b>Includes</b></p> <p align="center">2 x Leaf Springs      2 x Shocks 2 x U-Bolt Kits      1 x Urethane Kit</p>			

Vehicle fitment sheet must be completed when suspension fitted. Failure to do so may affect warranty.  
Fitment sheet can be found on page 200 of this catalogue

**KIT PRICING REFERENCE  
COMPONENTS AS PER IMAGE**  
*please order using part numbers*

**TOYOTA**  
**LANDCRUISER**  
11/80-91  
**60, 61, 62 SERIES**

**REAR SUSPENSION**

PART NO.	QTY	DESCRIPTION	RRP inc GST	NOTES
<b>SHOCK ABSORBERS</b>				
FC41366	2	41mm Foam Cell Shocks		Suit OE Height
BM401366	2	40mm 9 Stage Adjustable Shock		11/80-10/85 Models ONLY
FC41382	2	41mm Foam Cell Shocks		Suit 50mm Lift 11/80-10/85 Models ONLY
BM401382	2	40mm 9 Stage Adjustable		
FC41350	2	41mm Foam Cell Shocks		Suits Up to 50mm 10/85-91 Models ONLY
BM401350	2	40mm 9 Stage Adjustable		
<b>LEAF SPRINGS</b>				
T44L	2	0-300Kg Load		50mm Lift Spring
T44H	2	<b>CONSTANT</b> 300Kg Load		50mm Lift Spring
T44HM	2	<b>CONSTANT</b> 500Kg Load		50mm Lift Spring
<b>COMPONENTS</b>				
TDUK-012	1	Urethane Shackle Bushing Kit		
TDUB-017	2	U-Bolt Kit		
TDGP-351	1	Greasable pins		
TDGS-357	1	Greasable Shackles		

**REPLACEMENT BUSHINGS**

<b>QUANTITY PER SHOCK</b>				
TW959	2	Suits Top Front Pin		Pin Style Bushing
ADJ00191	1	Suits Bottom Front Eying		Eying Bushing
404702	2	Suits Top & Bottom Rear Eying		Eying Bushing (#1382)
ADJ00191	2	Suits Top & Bottom Rear Eying		Eying Bushing (#1350)

**REAR KIT PRICE REFERENCE**

SHOCK CHOICE	SPRING CHOICE	RRP inc GST	CONTENTS
<b>41mm Foam Cell</b>	T44L 0-300Kg		
	T44H 300Kg + T44HM 500Kg +		
<b>40mm 9 Stage Adjustable</b>	T44L 0-300Kg		
	T44H 300Kg + T44HM 500Kg +		
<b>Includes</b> 2 x Leaf Springs      2 x Shocks 1 x Urethane Kits      2 x U-Bolt Kits			

*Freight should be added where required. When determining spring choice, include only permanent accessories & weights. Towing requirements are not included in constant load determination*

# TOYOTA

## LANDCRUISER

11/84-91  
70 SERIES BUNDERA



### FRONT SUSPENSION

**ESTIMATED LIFT: 40mm**

PART NO.	QTY	DESCRIPTION	RRP inc GST	NOTES
<b>SHOCK ABSORBERS</b>				
FC41005	2	41mm Foam Cell Shocks		OE Height
FC41007	2	41mm Foam Cell Shocks		40mm Lift
<b>COIL SPRINGS</b>				
TDC941L	2	40mm Lift Spring		Suit Petrol/Diesel/Bar
<b>STEERING DAMPERS</b>				
EXT5001	1	H/D Replacement Damper		
SS5001-P/S	1	Return to Centre Damper		
SV5001	1	9 Stage Adjustable Damper		
<b>COMPONENTS</b>				
TDUK-042	1	Radius Rod to Diff		2 Kits Required
TDUK-041	1	Radius Rod to Chassis		1 Kit Required

### REAR SUSPENSION

<b>SHOCK ABSORBERS</b>				
FC43005	1	41mm Foam Cell Shocks		OE Height - D/S
FC41107	1	41mm Foam Cell Shocks		OE Height - P/S
FC41350	1	41mm Foam Cell Shocks		40mm Lift - D/S
FC41108	1	41mm Foam Cell Shocks		40mm Lift - P/S
<b>COIL SPRINGS</b>				
TDC942L	2	0-300Kg Load		40mm Lift Spring
<b>COMPONENTS</b>				
TDUK-042	1	Radius Rod to Diff		2 Kits Required
TDUK-041	1	Radius Rod to Chassis		1 Kit Required

### REPLACEMENT BUSHINGS

<b>QUANTITY PER SHOCK (check shock fittings prior to ordering)</b>				
TW959	4	Suits Top & Bottom Front Pin		Pin Style Bushing
TW959	2	Suits Top Rear Pin		Eyering Bushing #1108 & #1107
ADJ00191	2	Suits Top & Bottom Rear Eyering		Eyering Bushing #1350 & #3005
ADJ00191	2	Suits Top & Bottom Eye		Eyering Bushing #1108 & #1107

### COMPLETE KIT PRICE REFERENCE

SHOCK CHOICE	SPRING CHOICE	RRP inc GST	CONTENTS
41mm Foam Cell	40mm LIFT		
<b>Includes</b> 4 x Coil Springs    4 x Shocks			

Vehicle fitment sheet must be completed when suspension fitted. Failure to do so may affect warranty.  
Fitment sheet can be found on page 200 of this catalogue



# TOYOTA

## LANDCRUISER

### HZJ71 & HZJ74

### 71, 74 SERIES SWB & LWB

## FRONT SUSPENSION

**ESTIMATED LIFT: 50mm**

PART NO.	QTY	DESCRIPTION	RRP inc GST	NOTES
<b>SHOCK ABSORBERS</b>				
FC41050	2	41mm Foam Cell Shocks		Up to 50mm Lift
BM401050	2	40mm 9 Stage Adjustable		Up to 50mm Lift
BMX1050/2	2	45mm 9 Stage Adjustable		50mm Lift
TDR1050B	2	53mm 'Ralph' Big Bore		Up to 50mm Lift
<b>COIL SPRINGS</b>				
TDC950SL	2	50mm Lift Spring		Suit Petrol/Diesel/Bar
TDC950L	2	50mm Lift Spring		Suit Petrol/Diesel/Bar/Winch
<b>STEERING DAMPERS</b>				
EXT5001	1	H/D Replacement Damper		
SS5001-P/S	1	Return to Centre Damper		
SV5001	1	9 Stage Adjustable Damper		

## REAR SUSPENSION

<b>SHOCK ABSORBERS</b>				
FC41377	2	41mm Foam Cell Shocks		50mm Lift
BM401377	2	40mm 9 Stage Adjustable		50mm Lift
BMX1377/2	2	45mm 9 Stage Adjustable		50mm Lift
TDR1377	2	53mm 'Ralph' Big Bore		50mm Lift
<b>LEAF SPRINGS</b>				
T44L	2	0-300Kg Load		50mm Lift Spring
T44H	2	<b>CONSTANT</b> 300Kg Load		50mm Lift Spring
<b>COMPONENTS</b>				
TDUK-012	1	Urethane Bushing kit		1 Kits Required
TDUB-017	2	U-Bolt Kits		2 Kit Required

## FRONT END KIT PRICE REFERENCE

SHOCK CHOICE	SPRING CHOICE	RRP inc GST	CONTENTS
41mm Foam Cell	0-300KG		
	300KG +		
40mm 9 Stage Adjustable	0-300KG		
	300KG +		
45mm Adjustable or 53mm Ralph	0-300KG		
	300KG +		
<p align="center"><b>Includes</b></p> <p align="center">2 X Coil Springs 2 x Leaf Springs 4 x Shocks</p> <p align="center">2 x U-Bolt Kits 1 x Urethane Kit</p>			

Freight should be added where required. When determining spring choice, include only permanent accessories & weights. Towing requirements are not included in constant load determination

# TOYOTA

## LANDCRUISER

11/84-92  
70, 73, 74 SERIES



### FRONT SUSPENSION

**ESTIMATED LIFT: 50mm**

PART NO.	QTY	DESCRIPTION	RRP inc GST	NOTES
<b>SHOCK ABSORBERS</b>				
FC41113	2	41mm Foam Cell Shocks		OE Height
BM401113	2	40mm 9 Stage Adjustable		OE Height
FC41163	2	41mm Foam Cell Shocks		50mm Lift
BM401163	2	40mm 9 Stage Adjustable		50mm Lift
BMX1163/2	2	45mm 9 Stage Adjustable		50mm Lift
TDR1163B	2	53mm 'Ralph' Big Bore		50mm Lift
<b>LEAF SPRINGS</b>				
T52	2	50mm Lift Spring		Suit Petrol/Diesel/Bar
<b>STEERING DAMPERS</b>				
EXT5001	1	H/D Replacement Damper		
SS5001-P/S	1	Return to Centre Damper		
SV5001	1	9 Stage Adjustable Damper		
<b>COMPONENTS</b>				
TDUK-012	1	Urethane Bushing kit		1 Kits Required
TDUB-019	2	U-Bolt Kits		2 Kit Required
TDGP-351	1	Greasable Pins		
TDGS-357	1	Greasable Shackles		
TAK-005	1	Offset King Pin		Fits to Top of Knuckle
TAK-075	1	Offset King Pin		Fits to Top of Knuckle
TAK-001	1	Offset King Pin		Fits to Top of Knuckle

### REPLACEMENT BUSHINGS

<b>QUANTITY PER SHOCK (check shock fittings prior to ordering)</b>				
TW959	2	Suits Top front Pin		Pin Style Bushing
ADJ00191	1	Suits Bottom Front Eye		Eyering Bushing
ADJ00191	2	Suits Top & Bottom Rear Eyering		Eyering Bushing

Vehicle fitment sheet must be completed when suspension fitted. Failure to do so may affect warranty.  
Fitment sheet can be found on page 200 of this catalogue

# TOYOTA

## LANDCRUISER

11/84-92  
70, 73, 74 SERIES

### REAR SUSPENSION

PART NO.	QTY	DESCRIPTION	RRP inc GST	NOTES
<b>SHOCK ABSORBERS</b>				
FC41350	2	41mm Foam Cell Shocks		OE Height
BM401350	2	40mm 9 Stage Adjustable		OE Height
FC41377	2	41mm Foam Cell Shocks		50mm Lift
BM401377	2	40mm 9 Stage Adjustable		50mm Lift
BMX1377/2	2	45mm 9 Stage Adjustable		50mm Lift
TDR1377	2	53mm 'Ralph' Big Bore		50mm Lift
<b>LEAF SPRINGS</b>				
T44L	2	0-300Kg Load		50mm Lift Spring
T44H	2	<b>CONSTANT</b> 300Kg Load		50mm Lift Spring
<b>COMPONENTS</b>				
TDUK-012	1	Urethane Bushing kit		1 Kits Required
TDUB-017	2	U-Bolt Kits		2 Kit Required
TDGP-351	1	Greasable Pins		
TDGS-357	1	Greasable Shackles		

### COMPLETE KIT PRICE REFERENCE

SHOCK CHOICE	SPRING CHOICE	RRP inc GST	CONTENTS
41mm Foam Cell	T44L 0-300Kg		
	T44H 300Kg +		
40mm 9 Stage Adjustable	T44L 0-300Kg		
	T44H 300Kg +		
45mm 9 Stage Adjustable or 53mm Ralph	T44L 0-300Kg		
	T44H 300Kg +		
<b>Includes</b> 4 x Leaf Springs      4 x Shocks 2 x Urethane Kits      4 x U-Bolt Kits			

Freight should be added where required. When determining spring choice, include only permanent accessories & weights. Towing requirements are not included in constant load determination

# TOYOTA

## LANDCRUISER

11/84-99  
75 SERIES



### FRONT SUSPENSION

**ESTIMATED LIFT: 50mm**

PART NO.	QTY	DESCRIPTION	RRP inc GST	NOTES
<b>SHOCK ABSORBERS</b>				
FC41113B	2	41mm Foam Cell Shocks		Suit OE Height
FC41163B	2	41mm Foam Cell Shocks		Suit 50mm Lift (HZJ75 3/90-99)
FC41163	2	41mm Foam Cell Shocks		Suit 50mm Lift All except HZJ75
BM401163	2	40mm 9 Stage Adjustable Shock		Suits All Models
BMX1163/2	2	45mm 9 Stage Adjustable		
TDR1163B	2	53mm 'Ralph' Big Bore		
<b>LEAF SPRINGS</b>				
T52	2	50mm Lift Spring		Petrol/Diesel/Bar
T52H	2	50mm Lift Spring		Petrol/Diesel/Bar/Winch
<b>STEERING STABILIZERS</b>				
EXT5001	1	H/Duty Replacement Damper		Suits Power Steering
SS5001-P/S	1	Return to Centre Damper		
SV5001	1	9 Stage Adjustable Dampers		
<b>COMPONENTS</b>				
TDUK-012	1	Urethane Shackle Bushing Kit		0.5 Degree 0.75 Degree 1.0 Degree
TDUB-019	2	U-Bolt Kit		
TDGP-351	1	Greasable pins		
TDGS-357	1	Greasable Shackles		
TAK-005	1	Offset King Pin		
TAK-075	1	Offset King Pin		
TAK-001	1	Offset King Pin		

### FRONT END KIT PRICE REFERENCE

SHOCK CHOICE	SPRING CHOICE	RRP inc GST	CONTENTS
41mm Foam Cell	T52 T52H		
40mm 9 Stage Adjustable	T52 T52H		
45mm Adjustable or 53mm Ralph	T52 T52H		
<b>Includes</b> 2 x Leaf Springs    2 x Shocks 2 x U-Bolt Kits    1 x Urethane Kit			

Vehicle fitment sheet must be completed when suspension fitted. Failure to do so may affect warranty.  
Fitment sheet can be found on page 200 of this catalogue



**KIT PRICING REFERENCE  
COMPONENTS AS PER IMAGE**  
*please order using part numbers*

**TOYOTA**  
**LANDCRUISER**  
11/84-99  
**75 SERIES**

**REAR SUSPENSION**

PART NO.	QTY	DESCRIPTION	RRP inc GST	NOTES
<b>SHOCK ABSORBERS</b>				
FC41350	2	41mm Foam Cell Shocks		Suit OE Height
FC41377	2	41mm Foam Cell Shocks		
BM401377	2	40mm 9 Stage Adjustable Shock		Suit 50mm Lift
BMX1377/2	2	45mm 9 Stage Adjustable		
TDR1377	2	53mm 'Ralph' Big Bore		
<b>LEAF SPRINGS</b>				
T51	2	0-300Kg Load		50mm Lift Spring
FS751M	2	<b>CONSTANT</b> 300Kg Load		50mm Lift Spring
FS751HM	2	<b>CONSTANT</b> 500Kg Load		50mm Lift Spring
<b>COMPONENTS</b>				
TDUK-018	1	Urethane Shackle Bushing Kit		
TDUB-017	2	U-Bolt Kit		
TDGP-354	1	Greasable pins		
TDGS-357	1	Greasable Shackles		
<b>AIR ASSIST BAGS</b>				
TDAA-115	1	Bellows bag kit		Suits up to 75mm Lift

**REPLACEMENT BUSHINGS**

<b>QUANTITY PER SHOCK</b>				
TW959	2	Suits Top Front Pin		Pin Style Bushing
ADJ00191	1	Suits Bottom Front Eying		Eying Bushing
ADJ00191	2	Suits Top & Bottom Rear Eye		Eying Bushing

**REAR KIT PRICE REFERENCE**

SHOCK CHOICE	SPRING CHOICE	RRP inc GST	CONTENTS
<b>41mm Foam Cell</b>	T51 0-300Kg FS751M 300Kg + FS751HM 500Kg +		
<b>40mm 9 Stage Adjustable</b>	T51 0-300Kg FS751M 300Kg + FS751HM 500Kg +		
<b>45mm Adjustable or 53mm Ralph</b>	T51 0-300Kg FS751M 300Kg + FS751HM 500Kg +		
<b>Includes</b> 2 x Leaf Springs      2 x Shocks 1 x Urethane Kits      2 x U-Bolt Kits			

*Freight should be added where required. When determining spring choice, include only permanent accessories & weights. Towing requirements are not included in constant load determination*

# TOYOTA

## LANDCRUISER

07 on  
76 SERIES WAGON



### FRONT SUSPENSION

**ESTIMATED LIFT: 50mm**

PART NO.	QTY	DESCRIPTION	RRP inc GST	NOTES
<b>SHOCK ABSORBERS</b>				
FC41050	2	41mm Foam Cell Shocks		Up to 50mm Lift
BM401050	2	40mm 9 Stage Adjustable Shock		Up to 50mm Lift
BMX1050/2	2	45mm 9 Stage Adjustable		50mm Lift
TDR1050B	2	53mm 'Ralph' Big Bore		Up to 50mm Lift
<b>COIL SPRINGS</b>				
TDC950SL	2	OE Height Spring		Suits OE Height Petrol/Diesel/Bar
TDC950L	2	50mm Lift Spring		Petrol/Diesel/Bar
TDC950HL	2	50mm Lift Spring		Petrol/Diesel/Bar/Winch
<b>STEERING STABILIZERS</b>				
EXT5004	1	H/Duty Replacement Damper		Suits Power Steering
SS5004-P/S	1	Return to Centre Damper		
SV5004	1	9 Stage Adjustable Dampers		
<b>CASTER CORRECTION</b>				
TDUK-054/2	1	2 Degree Caster Correction		Optional Component
<b>PANHARD RODS</b>				
TDPR-015	1	Adjustable Panhard Rod		
<b>COMPONENTS</b>				
TDSP-013	1	Front Swaybar spacer kit		fit if tailshaft contacts swaybar 0.5 Degree 0.75 Degree 1.0 Degree
TAK-8005	1	Offset King Pin		
TAK-8075	1	Offset King Pin		
TAK-8001	1	Offset King Pin		
TDUK-1961/30	1	Urethane Spring Spacers 30mm		

### COMPLETE KIT PRICE REFERENCE

SHOCK CHOICE	SPRING CHOICE	RRP inc GST	CONTENTS
<b>41mm Foam Cell</b> <b>Includes</b> 2 x Coil Springs 4 x Shocks 2 x Leaf Springs 2 x U-Bolt Kits 1 x Urethane Kit (TDUK-048)	<b>FS761</b> <b>0-300KG</b>		
	<b>FS761M</b> <b>CONSTANT 300KG</b>		
	<b>FS761HM</b> <b>CONSTANT 500KG</b>		



**KIT PRICING REFERENCE  
COMPONENTS AS PER IMAGE**  
*please order using part numbers*

**TOYOTA**  
**LANDCRUISER**  
07 On  
**76 SERIES WAGON**

**REAR SUSPENSION**

PART NO.	QTY	DESCRIPTION	RRP inc GST	NOTES
<b>SHOCK ABSORBERS</b>				
FC41377	2	41mm Foam Cell Shocks		Up to 50mm Lift
BM401377	2	40mm 9 Stage Adjustable Shock		Up to 50mm Lift
BMX1377/2	2	45mm 9 Stage Adjustable		50mm Lift
TDR1377	2	53mm 'Ralph' Big Bore		Up to 50mm Lift
<b>LEAF SPRINGS - Check Eye Size Prior to Ordering</b>				
FS761	2	0-300Kg Load		50mm Lift Spring
FS761M	2	<b>CONSTANT</b> 300Kg Load		50mm Lift Spring
FS761HM	2	<b>CONSTANT</b> 500Kg Load		50mm Lift Spring
<b>COMPONENTS</b>				
TDUK-048	1	Urethane Bushing Kit pre 01/17		Use w Greasable pins & shackles (all years)
TDUK-048/14	1	Urethane Bushing Kit post 01/17		
TDUB-024	2	U-Bolt Kit		
TDSP-014	1	Brake Bias Bracket		Suits up to build date 01/2017
TDSP-015	1	Handbrake relocation bracket		Fit with BMX or TDR shocks
TDGP-388	1	Greasable pins		
TDGS-387/18	1	Greasable Shackles		
<b>AIR ASSIST BAGS</b>				
TDAA-115	1	Bellows bag kit		Suits up to 75mm Lift

**COMPLETE KIT PRICE REFERENCE** *Final Kit price varies by TDUK. Price shown incl. TDUK-048*

SHOCK CHOICE	SPRING CHOICE	RRP inc GST	CONTENTS
<b>40mm 9 Stage Adjustable</b> <b>Includes</b> 2 x Coil Springs 4 x Shocks 2 x Leaf Springs 2 x U-Bolt Kits 1 x Urethane Kit	FS761 0-300KG		
	FS761M CONSTANT 300KG		
	FS761HM CONSTANT 500KG		
<b>45mm Adjustable or 53mm 'Ralph' Big Bore</b> <b>Includes</b> 2 x Coil Springs 4 x Shocks 2 x Leaf Springs	FS761 0-300KG		
	FS761M CONSTANT 300KG		
	FS761HM CONSTANT 500KG		

*Freight should be added where required. When determining spring choice, include only permanent accessories & weights. Towing requirements are not included in constant load determination*

# TOYOTA

## LANDCRUISER

93-99

77 SERIES FZJ77, HZJ77, PZJ77



### FRONT SUSPENSION

**ESTIMATED LIFT: 50mm**

PART NO.	QTY	DESCRIPTION	RRP inc GST	NOTES
<b>SHOCK ABSORBERS</b>				
FC41113B	2	41mm Foam Cell Shocks		Suit OE Height
FC41163B	2	41mm Foam Cell Shocks		
BM401163	2	40mm 9 Stage Adjustable Shock		Suit 50mm Lift
BMX1163/2	2	45mm 9 Stage Adjustable		
TDR1163B	2	53mm 'Ralph' Big Bore		
<b>LEAF SPRINGS</b>				
T52	2	50mm Lift Spring		Petrol/Diesel/Bar
T52H	2	50mm Lift Spring		Petrol/Diesel/Bar/Winch
<b>STEERING STABILIZERS</b>				
EXT5001	1	H/Duty Replacement Damper		
SS5001-P/S	1	Return to Centre Damper		Suits Power Steering
SV5001	1	9 Stage Adjustable Dampers		
<b>COMPONENTS</b>				
TDUK-012	1	Urethane Shackle Bushing Kit		
TDUB-019	1	U-Bolt Kit		
TDGP-351	1	Greasable pins		
TDGS-348	1	Greasable Shackles		

### REAR SUSPENSION

<b>SHOCK ABSORBERS</b>				
FC41377	2	41mm Foam Cell Shocks		Up to 50mm Lift
BM401377	2	40mm 9 Stage Adjustable Shock		Up to 50mm Lift
BMX1377/2	2	45mm 9 Stage Adjustable		50mm Lift
TDR1377B	2	53mm 'Ralph' Big Bore		Up to 50mm Lift
<b>LEAF SPRINGS - Check Eye Size Prior to Ordering</b>				
FS761	2	0-300Kg Load		50mm Lift Spring
FS761M	2	<b>CONSTANT</b> 300Kg Load		50mm Lift Spring
<b>COMPONENTS</b>				
TDUK-018	1	Urethane Shackle Bushing Kit		
TDUB-017	2	U-Bolt Kit		
TDGP-354	1	Greasable pins		
TDGS-357	1	Greasable Shackles		

### REPLACEMENT BUSHINGS

<b>QUANTITY PER SHOCK (check shock fittings prior to ordering)</b>				
TW959	2	Suits Top Front Pin		Pin Style Bushing
ADJ00191	1	Suits Front Bottom Eye		Eyering Bushing
ADJ00191	2	Suits Top & Bottom Rear Eyering		Eyering Bushing

Vehicle fitment sheet must be completed when suspension fitted. Failure to do so may affect warranty.  
Fitment sheet can be found on page 200 of this catalogue



# TOYOTA LANDCRUISER KZJ78 (INTERNATIONAL 78 SERIES WITH COIL SPRINGS

## FRONT SUSPENSION

ESTIMATED LIFT: 50mm

PART NO.	QTY	DESCRIPTION	RRP inc GST	NOTES
<b>SHOCK ABSORBERS</b>				
FC41254	2	41mm Foam Cell Shocks		Up to 50mm Lift
BM401254	2	40mm 9 Stage Adjustable		Up to 50mm Lift
<b>COIL SPRINGS</b>				
TDC960L	2	50mm Lift Spring		Suit Petrol/Diesel/Bar
TDC960HL	2	50mm Lift Spring		Suit Petrol/Diesel/Bar/Winch
<b>STEERING DAMPERS</b>				
EXT5001	1	H/D Replacement Damper		
SS5001-P/S	1	Return to Centre Damper		
SV5001	1	9 Stage Adjustable Damper		

## REAR SUSPENSION

<b>SHOCK ABSORBERS</b>				
FC41255	2	41mm Foam Cell Shocks		50mm Lift
BM401255	2	40mm 9 Stage Adjustable		50mm Lift
<b>COIL SPRINGS</b>				
TDC961L	2	0-300Kg Load		50mm Lift Spring
TDC961HL	2	<b>CONSTANT</b> 300Kg Load		50mm Lift Spring

## FRONT END KIT PRICE REFERENCE

SHOCK CHOICE	SPRING CHOICE	RRP inc GST	CONTENTS
41mm Foam Cell	ANY COIL		
40mm 9 Stage Adjustable	ANY COIL		
<b>Includes</b> 4 x Coil Springs    4 x Shocks			

Freight should be added where required. When determining spring choice, include only permanent accessories & weights. Towing requirements are not included in constant load determination

# TOYOTA

## LANDCRUISER

10/99 On

78, 79 SERIES INC V8 (EXCEPT DUAL CAB)



### FRONT SUSPENSION

**ESTIMATED LIFT: 50mm**

PART NO.	QTY	DESCRIPTION	RRP inc GST	NOTES
<b>SHOCK ABSORBERS</b>				
FC41050	2	41mm Foam Cell Shocks		Up to 50mm Lift
BM401050	2	40mm 9 Stage Adjustable Shock		Up to 50mm Lift
BMX1050/2	2	45mm 9 Stage Adjustable		50mm Lift
TDR1050B	2	53mm 'Ralph' Big Bore		Up to 50mm Lift
<b>COIL SPRINGS</b>				
TDC950SL	2	OE Height Spring		Suits OE Height Petrol/Diesel/Bar
TDC950L	2	50mm Lift Spring		Petrol/Diesel/Bar
TDC950HL	2	50mm Lift Spring		Petrol/Diesel/Bar/Winch
<b>STEERING STABILIZERS</b>				
EXT5001	1	H/Duty Replacement Damper		Suits 6 Cylinder Models
SS5001-P/S	1	Return to Centre Damper		
SV5001	1	9 Stage Adjustable Dampers		
EXT5004	1	H/Duty Replacement Damper		Suits V8 Models
SS5004-P/S	1	Return to Centre Damper		
SV5004	1	9 Stage Adjustable Dampers		
<b>CASTER CORRECTION</b>				
TDUK-054/2	1	2 Degree Caster Correction		instructions at toughdog.com.au
<b>PANHARD RODS</b>				
TDPR-079	1	Adjustable Panhard Rod		Suits 6 Cylinder Engine
TDPR-015	1	Adjustable Panhard Rod		Suit V8 only up to '08/16
TDPR-006	1	Adjustable Panhard Rod		Suit V8 from '09/16 (5 star ANCAP)
TDPR-019	1	Adjustable Panhard Rod		LHD Vehicles (6 Cylinder)
<b>COMPONENTS</b>				
TDSP-013	1	Front Swaybar spacer kit		fit if tailshaft contacts swaybar
TDUK-1961/30	1	30mm Urethane Spring Spacer		
TDUK-043	1	Panhard Rod Bushings		Suits all Panhard Rods above
TAK-8005	1	Offset King Pin		0.5 Degree
TAK-8075	1	Offset King Pin		0.75 Degree
TAK-8001	1	Offset King Pin		1.0 Degree

### COMPLETE KIT PRICE REFERENCE

*Note: FS781XHD kit price includes rear sway bar*

SHOCK CHOICE	SPRING CHOICE	RRP inc GST	CONTENTS
<b>41mm Foam Cell</b> Includes 2 x Coil Springs 4 x Shocks 2 x Leaf Springs 2 x U-Bolt Kits 1 x Urethane Kit (TDUK-048)	BP-019 0-200KG		
	FS781 CONSTANT 400KG		
	FS781HM CONSTANT 600KG		
	FS781XHD CONSTANT 900KG		

Vehicle fitment sheet must be completed when suspension fitted. Failure to do so may affect warranty.  
Fitment sheet can be found on page 200 of this catalogue



Note: Urethane Bushing kit fitting instructions available at [toughdog.com.au](http://toughdog.com.au)

# TOYOTA LANDCRUISER 10/99 On 78, 79 SERIES INC V8 (EXCEPT DUAL CAB)

## REAR SUSPENSION

PART NO.	QTY	DESCRIPTION	RRP inc GST	NOTES
<b>SHOCK ABSORBERS</b>				
FC41377	2	41mm Foam Cell Shocks		Up to 50mm Lift
BM401377	2	40mm 9 Stage Adjustable Shock		Up to 50mm Lift
BMX1377/2	2	45mm 9 Stage Adjustable		50mm Lift
TDR1377	2	53mm 'Ralph' Big Bore		Up to 50mm Lift
<b>LEAF SPRINGS - **NOTE: Include weight of tray when calculating CONSTANT LOAD**</b>				
BP-019	2	0-200Kg Load		50mm Lift Spring
FS781	2	<b>CONSTANT</b> 400Kg Load		50mm Lift Spring
FS781HM	2	<b>CONSTANT</b> 600Kg Load		50mm Lift Spring
FS781XHD	2	<b>CONSTANT</b> 900Kg Load		50mm Lift - Fit TDSB-008 also
<b>COMPONENTS</b>				
TDSB-008	1	Heavy Duty Sway Bar		Fit with Constant 800kg springs
TDUK-048	1	Urethane Shackle Bushing Kit		Suits V8 & w G' Pins & Shackles
TDUK-048/14	1	Urethane Shackle Bushing Kit		For Utes built before 06/2009
TDUK-048/18	1	Urethane Shackle Bushing Kit		For T'carrier built before 06/2009
TDUB-024	2	U-Bolt Kit		
TDUB-038	2	U-Bolt Kit		For use with FS781XHD
TDSP-014	1	Brake Bias Bracket		Not req'd when built after 01/17
TDSP-015	1	Handbrake relocation bracket		Fit with BMX or TDR shocks
TDGP-388	1	Greasable pins		
TDGS-387/18	1	Greasable Shackles		
<b>AIR ASSIST BAGS</b>				
TDAA-115	1	Bellows bag kit		Suits up to 75mm Lift

## COMPLETE KIT PRICE REFERENCE Final Kit price varies by TDUK. Price shown incl. TDUK-048

SHOCK CHOICE	SPRING CHOICE	RRP inc GST	CONTENTS
<b>40mm 9 Stage Adjustable</b> Includes 2 x Coil Springs 4 x Shocks 2 x Leaf Springs 2 x U-Bolt Kits 1 x Urethane Kit	BP-019 - 0-200KG		 <p><b>Note: FS781XHD kit price includes rear sway bar</b></p>
	FS781 CONSTANT 400KG		
	FS781HM CONSTANT 600KG		
	FS781XHD CONSTANT 900KG		
<b>45mm Adjustable or 53mm 'Ralph' Big Bore</b> Includes 2 x Coil Springs 4 x Shocks 2 x Leaf Springs	BP-019 - 0-200KG		
	FS781 CONSTANT 400KG		
	FS781HM CONSTANT 600KG		
	FS781XHD CONSTANT 900KG		

Freight should be added where required. When determining spring choice, include only permanent accessories & weights. Towing requirements are not included in constant load determination

P: (02) 9672 8899 | F: (02) 9672 8099



# TOYOTA

## LANDCRUISER

### 12 On

### 79 SERIES DUAL CAB



## FRONT SUSPENSION

**ESTIMATED LIFT: 50mm**

PART NO.	QTY	DESCRIPTION	RRP inc GST	NOTES
<b>SHOCK ABSORBERS</b>				
FC41050	2	41mm Foam Cell Shocks		Up to 50mm Lift
BM401050	2	40mm 9 Stage Adjustable Shock		Up to 50mm Lift
BMX1050/2	2	45mm 9 Stage Adjustable		50mm Lift
TDR1050B	2	53mm 'Ralph' Big Bore		Up to 50mm Lift
<b>COIL SPRINGS</b>				
TDC950SL	2	OE Height Spring		Suits OE Height Petrol/Diesel/Bar
TDC950L	2	50mm Lift Spring		Petrol/Diesel/Bar
TDC950HL	2	50mm Lift Spring		Petrol/Diesel/Bar/Winch
<b>STEERING STABILIZERS</b>				
EXT5004	1	H/Duty Replacement Damper		Suits V8 Models
SS5004-P/S	1	Return to Centre Damper		
SV5004	1	9 Stage Adjustable Dampers		
<b>CASTER CORRECTION</b>				
TDUK-054/2	1	2 Degree Caster Correction		instructions at toughdog.com.au
<b>PANHARD RODS</b>				
TDPR-015	1	Adjustable Panhard Rod		
<b>COMPONENTS</b>				
TDSP-013	1	Front Swaybar spacer kit		fit if tailshaft contacts swaybar
TDUK-1961/30	1	30mm Urethane Spring Spacer		
TAK-8005	1	Offset King Pin		0.5 Degree
TAK-8075	1	Offset King Pin		0.75 Degree
TAK-8001	1	Offset King Pin		1.0 Degree

## REPLACEMENT BUSHINGS

QUANTITY PER SHOCK				
TW957	4	Suits Top & Bottom Front Pin		Pin Style Bushing
ADJ00191	2	Suits Top & Bottom Rear Eye		Eyering Bushing

## COMPLETE KIT PRICE REFERENCE

SHOCK CHOICE	SPRING CHOICE	RRP inc GST	CONTENTS
<b>41mm Foam Cell</b> <b>Includes</b> 2 x Coil Springs 4 x Shocks 2 x Leaf Springs 2 x U-Bolt Kits 1 x Urethane Kit (TDUK-048)	<b>FS781</b> <b>CONSTANT 300KG</b>		
	<b>FS781HM</b> <b>CONSTANT 500KG</b>		
	<b>FS781XHD</b> <b>CONSTANT 800KG</b>		

Vehicle fitment sheet must be completed when suspension fitted. Failure to do so may affect warranty.  
 Fitment sheet can be found on page 200 of this catalogue





**Note: Urethane Bushing kit fitting instructions available at [toughdog.com.au](http://toughdog.com.au)**

# TOYOTA LANDCRUISER 12 On 79 SERIES DUAL CAB

## REAR SUSPENSION

PART NO.	QTY	DESCRIPTION	RRP inc GST	NOTES
<b>SHOCK ABSORBERS</b>				
FC41377	2	41mm Foam Cell Shocks		Up to 50mm Lift
BM401377	2	40mm 9 Stage Adjustable Shock		Up to 50mm Lift
BMX1377/2	2	45mm 9 Stage Adjustable		50mm Lift
TDR1377	2	53mm 'Ralph' Big Bore		Up to 50mm Lift
<b>LEAF SPRINGS - OE vehicle weight based on cab chassis (excludes tub/tray)</b>				
FS781	2	<b>CONSTANT</b> 300Kg Load		50mm Lift Spring
FS781HM	2	<b>CONSTANT</b> 500Kg Load		50mm Lift Spring
FS781XHD	2	<b>CONSTANT</b> 800Kg Load		50mm Lift - Fit TDSB-008 also
<b>COMPONENTS</b>				
TDSB-008	1	Heavy Duty Sway Bar		Fit with Constant 700kg springs
TDUK-048	1	Urethane Shackle Bushing Kit		
TDUB-024	2	U-Bolt Kit		
TDUB-038	2	U-Bolt Kit		For use with FS781XHD
TDSP-014	1	Brake Bias Bracket		Not req'd when built after 01/17
TDSP-015	1	Handbrake relocation bracket		Fit with BMX or TDR shocks
TDGP-388	1	Greasable pins		
TDGS-387/18	1	Greasable Shackles		
<b>AIR ASSIST BAGS</b>				
TDAA-115	1	Bellows bag kit		Suits up to 75mm Lift

## COMPLETE KIT PRICE REFERENCE

SHOCK CHOICE	SPRING CHOICE	RRP inc GST	CONTENTS
<b>40mm 9 Stage Adjustable</b> <b>Includes</b> 2 x Coil Springs 4 x Shocks 2 x Leaf Springs 2 x U-Bolt Kits 1 x Urethane Kit (TDUK-048)	<b>FS781</b> <b>CONSTANT 300KG</b>		
	<b>FS781HM</b> <b>CONSTANT 500KG</b>		
	<b>FS781XHD</b> <b>CONSTANT 800KG</b>		
<b>45mm Adjustable or 53mm 'Ralph' Big Bore</b> <b>Includes</b> 2 x Coil Springs 4 x Shocks 2 x Leaf Springs 2 x U-Bolt Kits 1 x Urethane Kit 1 x H'brake bkt Kit	<b>FS781</b> <b>CONSTANT 300KG</b>		
	<b>FS781HM</b> <b>CONSTANT 500KG</b>		
	<b>FS781XHD</b> <b>CONSTANT 800KG</b>		

Note: FS781XHD kit price includes rear sway bar

Freight should be added where required. When determining spring choice, include only permanent accessories & weights. Towing requirements are not included in constant load determination

# TOYOTA

## LANDCRUISER

3/90-07  
80 & 105 SERIES



### FRONT SUSPENSION

**ESTIMATED LIFT: 50mm**

PART NO.	QTY	DESCRIPTION	RRP inc GST	NOTES
<b>SHOCK ABSORBERS</b>				
FC41002	2	41mm Foam Cell Shocks		Suits up to 50mm Lift
BM401002	2	40mm 9 Stage Adjustable Shock		Suits up to 50mm Lift
BMX1002/2	2	45mm 9 Stage Adjustable Shock		Suits 50mm Lift ONLY
TDR1002B	2	53mm 'Ralph' Big Bore Shock		Suits up to 50mm Lift
<b>COIL SPRINGS</b>				
TDC943S	2	Petrol/Alloy Bar		3/90-91 80 Series Application <b>Suits 25mm Lift</b>
TDC948L	2	Diesel/Bar		
TDC948HL	2	Petrol/Diesel Bar & Winch		
TDC943	2	Petrol/Diesel Bar		3/90-91 80 Series Application <b>Suits 50mm Lift</b>
TDC943H	2	Petrol/Diesel Bar & Winch		
TDC948SL	2	Petrol/Alloy Bar		9/91-98 80 Series & 3/98-07 100 Series Application <b>Suits 25mm Lift</b>
TDC948HSL	2	Petrol/Diesel Bar & Winch		
TDC948L	2	Petrol Deisel Bar, Winch & D/Batt		
TDC943S	2	80 Series ONLY No bar		9/91-98 80 Series & 3/98-07 100 Series Application <b>Suits 50mm Lift</b>
TDC948L	2	Petrol/Diesel/Bar		
TDC948HL	2	Petrol Diesel/Bar/Winch		
TDC943H	2	Petrol Diesel/Bar/Winch/D.Batt		
<b>STEERING STABILIZERS</b>				
EXT5001	1	H/Duty Replacement Damper		
SS5001-P/S	1	Return to Centre Damper		
SV5001	1	9 Stage Adjustable Damper		
<b>CASTER CORRECTION</b>				
TDUK-054/2	1	2 Degree Caster Correction Bush		instructions at toughdog.com.au
<b>PANHARD ROD</b>				
TDPR-006	1	Adjustable Panhard Rod		
TDPR-001	1	Adjustable Panhard Rod		LHD ONLY
<b>COMPONENTS</b>				
TDUK-044	1	Front Radius Rod to Chassis		1 Kit required per vehicle
TDUK-050	1	Front Radius Rod to Diff		1 Kit required per vehicle
TDUK-043	1	Panhard Rod Bush Kit		1 Kit required per panhard rod
TDUK-1725/20	1	Urethane Spring Spacer 20mm		1 required per coil as required
TDUK-1725/30	1	Urethane Spring Spacer 30mm		1 required per coil as required
TAK-8005	1	Offset Kingpin		0.5 Degree
TAK-8075	1	Offset Kingpin		0.75 Degree
TAK-8001	1	Offset Kingpin		1.0 Degree

### REPLACEMENT BUSHINGS

<b>QUANTITY PER SHOCK (check shock fittings prior to ordering)</b>				
TW957	4	Suits Top & Bottom Front Pin		Pin Style Bushing
TW957	2	Suits Top Rear Pin		Pin Style Bushing
415024	1	Suits Bottom Rear Eying		Eying Bushing

Vehicle fitment sheet must be completed when suspension fitted. Failure to do so may affect warranty.

Fitment sheet can be found on page 200 of this catalogue

**KIT PRICING REFERENCE  
COMPONENTS AS PER IMAGE**  
*please order using part numbers*

**TOYOTA**  
**LANDCRUISER**  
3/90-07  
**80 & 105 SERIES**

**REAR SUSPENSION**

PART NO.	QTY	DESCRIPTION	RRP inc GST	NOTES
<b>SHOCK ABSORBERS</b>				
FC41111	2	41mm Foam Cell Shocks		Suits up to 50mm Lift
BM401111	2	40mm 9 Stage Adjustable Shock		Suits up to 50mm Lift
BMX1111/2	2	45mm 9 Stage Adjustable Shock		Suits 50mm Lift ONLY
TDR1111	2	53mm 'Ralph' Big Bore Shock		Suits up to 50mm Lift
<b>COIL SPRINGS</b>				
TDC945S	2	25mm Lift 0-300Kg Load		3/90-91 80 Series Application <b>Suits 25mm Lift</b>
TDC949L	2	25mm Lift <b>CONSTANT 300kg</b>		
TDC949HL	2	25mm Lift <b>CONSTANT 500kg</b>		
TDC945	2	50mm Lift 0-300Kg Load		3/90-91 80 Series Application <b>Suits 50mm Lift</b>
TDC945H	2	50mm Lift <b>CONSTANT 300kg</b>		
TDC949SL	2	25mm Lift 0-300Kg Load		9/91-98 80 Series & 3/98-07 100 Series Application <b>Suits 25mm Lift</b>
TDC949HSL	2	25mm Lift <b>CONSTANT 300kg</b>		
TDC949L	2	25mm Lift <b>CONSTANT 500kg</b>		
TDC945S	2	50mm Lift No Load		9/91-98 80 Series & 3/98-07 100 Series Application <b>Suits 50mm Lift</b>
TDC949L	2	50mm Lift 0-300Kg Load		
TDC949HL	2	50mm Lift <b>CONSTANT 300kg</b>		
TDC945H	2	50mm Lift <b>CONSTANT 500kg</b>		
<b>PANHARD ROD</b>				
TDPR-007	1	Adjustable Panhard Rod		
<b>COMPONENTS</b>				
TDUK-045	1	Trailing Arm Bushing Kit ( <b>Upper</b> )		1 Kit required ( <b>Upper</b> )
TDUK-046	1	Trailing Arm Bushing Kit ( <b>Lower</b> )		1 Kit required ( <b>Lower</b> )
TDUK-047	1	Panhard Rod Bush Kit		1 Kit required per panhard rod
TDUK-1724/15	1	Urethane Spring Spacer 15mm		1 per coil as required
TDUK-1724/30	1	Urethane Spring Spacer 30mm		1 per coil as required
<b>AIR ASSIST BAGS</b>				
TDAA-010	1	Coil insert bag kit		Suits up to 25mm Lift
TDAA-011	1	Coil insert bag kit		Suits up to 50mm Lift

**COMPLETE KIT PRICE REFERENCE**

SHOCK CHOICE	SPRING CHOICE	RRP inc GST	CONTENTS
41mm Foam Cell	\$135 Rear Coils		
	\$175 Rear Coils		
	\$196 Rear Coils		
40mm 9 Stage Adjustable	\$135 Rear Coils		
	\$175 Rear Coils		
	\$196 Rear Coils		
45mm Big Bore or 53mm 'Ralph'	\$135 Rear Coils		
	\$175 Rear Coils		
	\$196 Rear Coils		

*Freight should be added where required. When determining spring choice, include only permanent accessories & weights. Towing requirements are not included in constant load determination*

# TOYOTA

## LANDCRUISER

1/90-07

80 & 105 SERIES 3" LIFT



### FRONT SUSPENSION

**ESTIMATED LIFT: 75mm**

PART NO.	QTY	DESCRIPTION	RRP inc GST	NOTES
<b>SHOCK ABSORBERS</b>				
FC41002	2	41mm Foam Cell Shocks		Suits 75mm Lift
BM401002	2	40mm 9 Stage Adjustable Shock		Suits 75mm Lift
BMX1002/2	2	45mm 9 Stage Adjustable Shock		Suits 75mm Lift
TDR1002B	2	53mm 'Ralph' Big Bore Shock		Suits 75mm Lift
<b>COIL SPRINGS</b>				
TDC943	2	Petrol/Alloy Bar		75mm Lift Spring
TDC948/3	2	Diesel/Bar		75mm Lift Spring
TDC943H	2	Petrol/Diesel Bar & Winch		75mm Lift Spring
<b>STEERING STABILIZERS</b>				
EXT5001	1	H/Duty Replacement Damper		
SS5001-P/S	1	Return to Centre Damper		
SV5001	1	9 Stage Adjustable Damper		
<b>CASTER CORRECTION</b>				
TDUK-054/2	1	2 Degree Caster Correction Bush		instructions at toughdog.com.au
<b>PANHARD ROD</b>				
TDPR-006	1	Adjustable Panhard Rod		
TDPR-001	1	Adjustable Panhard Rod		LHD ONLY
<b>COMPONENTS</b>				
TDUK-044	1	Front Radius Rod to Chassis		1 Kit required per vehicle
TDUK-050	1	Front Radius Rod to Diff		1 Kit required per vehicle
TDUK-043	1	Panhard Rod Bush Kit		1 Kit required per panhard rod
TDUK-1725/20	1	Urethane Spring Spacer 20mm		1 required per coil as required
TDUK-1725/30	1	Urethane Spring Spacer 30mm		1 required per coil as required
TAK-8005	1	Offset Kingpin		0.5 Degree
TAK-8075	1	Offset Kingpin		0.75 Degree
TAK-8001	1	Offset Kingpin		1.0 Degree
<b>BRAKE HOSE KITS</b>				
TDBH-003	1	Rubber Brake Hose Kit		80 & 105 Series Non ABS
TDBH-197	1	Braided Brake Hose Kit		
TDBH-300	1	Rubber Brake Hose Kit		80 Series with ABS
TDBH-200	1	Braided Brake Hose Kit		
TDBH-398	1	Rubber Brake Hose Kit		105 Series with ABS
TDBH-198	1	Braided Brake Hose Kit		

**FOR REPLACEMENT BUSHING PART NUMBERS, PLEASE SEE PAGE (P178) PREVIOUS IN CATALOGUE**

Vehicle fitment sheet must be completed when suspension fitted. Failure to do so may affect warranty.  
Fitment sheet can be found on page 200 of this catalogue

**KIT PRICING REFERENCE  
COMPONENTS AS PER IMAGE**  
*please order using part numbers*

**TOYOTA**  
**LANDCRUISER**  
1/90-07  
**80 & 105 SERIES 3" LIFT**

**REAR SUSPENSION**

PART NO.	QTY	DESCRIPTION	RRP inc GST	NOTES
<b>SHOCK ABSORBERS</b>				
FC41111	2	41mm Foam Cell Shocks		Suits 75mm Lift
BM401111	2	40mm 9 Stage Adjustable Shock		Suits 75mm Lift
BMX1111/2	2	45mm 9 Stage Adjustable Shock		Suits 75mm Lift
TDR1111	2	53mm 'Ralph' Big Bore Shock		Suits 75mm Lift
<b>COIL SPRINGS</b>				
TDC949/3	2	75mm Lift 0-300Kg Load		75mm Lift Spring
TDC945	2	75mm Lift <b>CONSTANT 300kg</b>		75mm Lift Spring
TDC945H	2	75mm Lift <b>CONSTANT 500kg</b>		75mm Lift Spring
<b>PANHARD ROD</b>				
TDPR-007	1	Adjustable Panhard Rod		
<b>COMPONENTS</b>				
TDUK-045	1	Trailing Arm Bushing Kit ( <b>Upper</b> )		1 Kit required ( <b>Upper</b> )
TDUK-046	1	Trailing Arm Bushing Kit ( <b>Lower</b> )		1 Kit required ( <b>Lower</b> )
TDUK-047	1	Panhard Rod Bush Kit		1 Kit required per panhard rod
TDUK-1724/15	1	Urethane Spring Spacer 15mm		1 per coil as required
TDUK-1724/30	1	Urethane Spring Spacer 30mm		1 per coil as required

**COMPLETE KIT PRICE REFERENCE**

SHOCK CHOICE	SPRING CHOICE	RRP inc GST	CONTENTS
41mm Foam Cell	\$135 (F) \$165 (R)		
	\$135 (F) \$175 (R)		
	\$135 (F) \$196 (R)		
	\$175 (F) \$165 (R)		
	\$175 (F & R)		
40mm 9 Stage Adjustable	\$135 (F) \$165 (R)		<p><b>Includes</b>                      4 x Coil Springs                      4 x Shocks                      2 x Panhard Rods                      1 x Caster Correction                      1 x Brake Hoses (TDBH-003)</p>
	\$135 (F) \$175 (R)		
	\$135 (F) \$196 (R)		
	\$175 (F) \$165 (R)		
	\$175 (F & R)		
45mm Big Bore or 53mm 'Ralph'	\$135 (F) \$165 (R)		
	\$135 (F) \$175 (R)		
	\$135 (F) \$196 (R)		
	\$175 (F) \$165 (R)		
	\$175 (F & R)		
	\$175 (F) \$196 (R)		

*Freight should be added where required. When determining spring choice, include only permanent accessories & weights. Towing requirements are not included in constant load determination*

# TOYOTA

## LANDCRUISER

1/90-07

80 & 105 SERIES 4" LIFT



### FRONT SUSPENSION

**ESTIMATED LIFT: 100mm (4")**

PART NO.	QTY	DESCRIPTION	RRP inc GST	NOTES
<b>SHOCK ABSORBERS</b>				
FC41002/4	2	41mm Foam Cell Shocks		Suits 100mm Lift
BMX1002/4	2	45mm 9 Stage Adjustable Shock		Suits 100mm Lift
<b>COIL SPRINGS</b>				
TDC948/4	2	Petrol/Diesel/Bar		100mm Lift Spring
TDC948/4H	2	Petrol/Diesel Bar & Winch		100mm Lift Spring
<b>STEERING STABILIZERS</b>				
SS5001-XHD	1	Return to Centre Damper		<b>SUITS RHD VEHICLE</b> Fitting instructions at <a href="http://toughdog.com.au">toughdog.com.au</a>
SV5001/4	1	9 Stage Adjustable Damper		
SS5002-XHD	1	Return to Centre Damper		<b>SUITS LHD VEHICLE</b> Fitting instructions at <a href="http://toughdog.com.au">toughdog.com.au</a>
SV5002/4	1	9 Stage Adjustable Damper		
<b>CASTER CORRECTION</b>				
TDUK-054/3	1	3 Degree Caster Correction Bush		instructions at <a href="http://toughdog.com.au">toughdog.com.au</a>
<b>PANHARD ROD</b>				
TDPR-006	1	Adjustable Panhard Rod		
TDPR-001	1	Adjustable Panhard Rod		LHD ONLY
<b>COMPONENTS</b>				
TDUK-044	1	Front Radius Rod to Chassis		1 Kit required per vehicle
TDUK-050	1	Front Radius Rod to Diff		1 Kit required per vehicle
TDUK-043	1	Panhard Rod Bush Kit		1 Kit required per panhard rod
TDUK-1725/20	1	Urethane Spring Spacer 20mm		1 required per coil as required
TDUK-1725/30	1	Urethane Spring Spacer 30mm		1 required per coil as required
TAK-8005	1	Offset Kingpin		0.5 Degree
TAK-8075	1	Offset Kingpin		0.75 Degree
TAK-8001	1	Offset Kingpin		1.0 Degree
<b>BRAKE HOSE KITS</b>				
TDBH-003	1	Rubber Brake Hose Kit		
TDBH-197	1	Braided Brake Hose Kit		80 & 105 Series Non ABS
TDBH-300	1	Rubber Brake Hose Kit		
TDBH-200	1	Braided Brake Hose Kit		80 Series with ABS
TDBH-398	1	Rubber Brake Hose Kit		
TDBH-198	1	Braided Brake Hose Kit		105 Series with ABS

**FOR REPLACEMENT BUSHING PART NUMBERS, PLEASE SEE  
PAGE (P178) PREVIOUS IN CATALOGUE**

Vehicle fitment sheet must be completed when suspension fitted. Failure to do so may affect warranty.  
Fitment sheet can be found on page 200 of this catalogue



**KIT PRICING REFERENCE  
COMPONENTS AS PER IMAGE**  
*please order using part numbers*

**TOYOTA**  
**LANDCRUISER**  
1/90-07  
**80 & 105 SERIES 4" LIFT**

**REAR SUSPENSION**

PART NO.	QTY	DESCRIPTION	RRP inc GST	NOTES
<b>SHOCK ABSORBERS</b>				
FC41111/4	2	41mm Foam Cell Shocks		Suits 100mm Lift
BMX1111/4	2	45mm 9 Stage Adjustable Shock		Suits 100mm Lift
<b>COIL SPRINGS</b>				
TDC949/4	2	100mm Lift 0-300Kg Load		100mm Lift Spring
TDC949/4H	2	100mm Lift <b>CONSTANT 300kg</b>		100mm Lift Spring
<b>PANHARD ROD</b>				
TDPR-007	1	Adjustable Panhard Rod		
<b>COMPONENTS</b>				
TDUK-045	1	Trailing Arm Bushing Kit ( <b>Upper</b> )		1 Kit required ( <b>Upper</b> )
TDUK-046	1	Trailing Arm Bushing Kit ( <b>Lower</b> )		1 Kit required ( <b>Lower</b> )
TDUK-047	1	Panhard Rod Bush Kit		1 Kit required per panhard rod
TDUK-1724/15	1	Urethane Spring Spacer 15mm		1 per coil as required
TDUK-1724/30	1	Urethane Spring Spacer 30mm		1 per coil as required

**COMPLETE KIT PRICE REFERENCE**

SHOCK CHOICE	SPRING CHOICE	RRP inc GST	CONTENTS
<b>41mm Foam Cell</b>	\$ 175 (F & R)		 <p><b>Includes</b> 4 x Coil Springs 4 x Shocks 2 x Panhard Rods 1 x Caster Correction 1 x Brake Hoses (TDBH-003)</p>
	\$185 (F) \$175 (R)		
	\$ 185 (F & R)		
<b>45mm Big Bore</b>	\$ 175 (F & R)		 <p><b>Includes</b> 4 x Coil Springs 4 x Shocks 2 x Panhard Rods 1 x Caster Correction 1 x Brake Hoses (TDBH-003)</p>
	\$185 (F) \$175 (R)		
	\$ 185 (F & R)		

*Freight should be added where required. When determining spring choice, include only permanent accessories & weights. Towing requirements are not included in constant load determination*

# TOYOTA

## LANDCRUISER

1/90-07

80 & 105 SERIES 5" LIFT



### FRONT SUSPENSION

**ESTIMATED LIFT: 125mm (5")**

PART NO.	QTY	DESCRIPTION	RRP inc GST	NOTES
<b>SHOCK ABSORBERS</b>				
BMX1002/6	2	45mm 9 Stage Adjustable Shock		Suits 125mm Lift
<b>COIL SPRINGS</b>				
TDC948/5	2	Petrol/Diesel/Bar		125mm Lift Spring
TDC948/5H	2	Petrol/Diesel Bar & Winch		125mm Lift Spring
<b>STEERING STABILIZERS</b>				
SS5001-XHD	1	Return to Centre Damper		<b>SUITS RHD VEHICLE</b>
SV5001/4	1	9 Stage Adjustable Damper		Fitting instructions at <a href="http://toughdog.com.au">toughdog.com.au</a>
SS5002-XHD	1	Return to Centre Damper		<b>SUITS LHD VEHICLE</b>
SV5002/4	1	9 Stage Adjustable Damper		Fitting instructions at <a href="http://toughdog.com.au">toughdog.com.au</a>
<b>CASTER CORRECTION</b>				
TDCP-006	1	5 Degree Caster Correction Plate		instructions at <a href="http://toughdog.com.au">toughdog.com.au</a>
<b>PANHARD ROD</b>				
TDPR-006	1	Adjustable Panhard Rod		
TDPR-001	1	Adjustable Panhard Rod		LHD ONLY
<b>COMPONENTS</b>				
TDUK-044	1	Front Radius Rod to Chassis		1 Kit required per vehicle
TDUK-050	1	Front Radius Rod to Diff		1 Kit required per vehicle
TDUK-043	1	Panhard Rod Bush Kit		1 Kit required per panhard rod
TDUK-1725/20	1	Urethane Spring Spacer 20mm		1 required per coil as required
TDUK-1725/30	1	Urethane Spring Spacer 30mm		1 required per coil as required
TAK-8005	1	Offset Kingpin		0.5 Degree
TAK-8075	1	Offset Kingpin		0.75 Degree
TAK-8001	1	Offset Kingpin		1.0 Degree
<b>BRAKE HOSE KITS</b>				
TDBH-003	1	Rubber Brake Hose Kit		80 & 105 Series Non ABS
TDBH-197	1	Braided Brake Hose Kit		
TDBH-300	1	Rubber Brake Hose Kit		80 Series with ABS
TDBH-200	1	Braided Brake Hose Kit		
TDBH-398	1	Rubber Brake Hose Kit		105 Series with ABS
TDBH-198	1	Braided Brake Hose Kit		

**FOR REPLACEMENT BUSHING PART NUMBERS, PLEASE SEE PAGE (P178) PREVIOUS IN CATALOGUE**

Vehicle fitment sheet must be completed when suspension fitted. Failure to do so may affect warranty.  
Fitment sheet can be found on page 200 of this catalogue



**KIT PRICING REFERENCE  
COMPONENTS AS PER IMAGE**  
*please order using part numbers*

# TOYOTA

## LANDCRUISER

1/90-07

**80 & 105 SERIES 5" LIFT**

### REAR SUSPENSION

PART NO.	QTY	DESCRIPTION	RRP inc GST	NOTES
<b>SHOCK ABSORBERS</b>				
BMX1111/6	2	45mm 9 Stage Adjustable Shock		Suits 125mm Lift
<b>COIL SPRINGS</b>				
TDC949/5	2	125mm Lift 0-300Kg Load		125mm Lift Spring
TDC949/5H	2	125mm Lift <b>CONSTANT 300kg</b>		125mm Lift Spring
<b>PANHARD ROD</b>				
TDPR-007	1	Adjustable Panhard Rod		
<b>COMPONENTS</b>				
TDUK-045	1	Trailing Arm Bushing Kit ( <b>Upper</b> )		1 Kit required ( <b>Upper</b> )
TDUK-046	1	Trailing Arm Bushing Kit ( <b>Lower</b> )		1 Kit required ( <b>Lower</b> )
TDUK-047	1	Panhard Rod Bush Kit		1 Kit required per panhard rod
TDUK-1724/15	1	Urethane Spring Spacer 15mm		1 per coil as required
TDUK-1724/30	1	Urethane Spring Spacer 30mm		1 per coil as required

### COMPLETE KIT PRICE REFERENCE

SHOCK CHOICE	SPRING CHOICE	RRP inc GST	CONTENTS
<b>45mm Big Bore 9 Stage Adjustable</b>		\$ 175 (F & R)	 <p><b>Includes</b> 4 x Coil Springs 4 x Shocks 2 x Panhard Rods 1 x Caster Correction 1 x Brake Hoses (TDBH-003)</p>
		\$175 (F) \$185 (R)	
		\$185 (F) \$175 (R)	
		\$185 (F & R)	

*Freight should be added where required. When determining spring choice, include only permanent accessories & weights. Towing requirements are not included in constant load determination*

**P: (02) 9672 8899 | F: (02) 9672 8099**



# TOYOTA

## LANDCRUISER

1/90-07

80 & 105 SERIES 6" LIFT



### FRONT SUSPENSION

ESTIMATED LIFT: 150mm (6")

PART NO.	QTY	DESCRIPTION	RRP inc GST	NOTES
<b>SHOCK ABSORBERS</b>				
BMX1002/6	2	45mm 9 Stage Adjustable Shock		Suits 150mm Lift
<b>COIL SPRINGS</b>				
TDC948/6	2	Petrol/Diesel/Bar		150mm Lift Spring
TDC948/6H	2	Petrol/Diesel Bar & Winch		150mm Lift Spring
<b>STEERING STABILIZERS</b>				
SS5001-XHD	1	Return to Centre Damper		<b>SUITS RHD VEHICLE</b>
SV5001/4	1	9 Stage Adjustable Damper		Fitting instructions at <a href="http://toughdog.com.au">toughdog.com.au</a>
SS5002-XHD	1	Return to Centre Damper		<b>SUITS LHD VEHICLE</b>
SV5002/4	1	9 Stage Adjustable Damper		Fitting instructions at <a href="http://toughdog.com.au">toughdog.com.au</a>
<b>CASTER CORRECTION</b>				
TDCP-006	1	5 Degree Caster Correction Plate		instructions at <a href="http://toughdog.com.au">toughdog.com.au</a>
<b>PANHARD ROD</b>				
TDPR-006	1	Adjustable Panhard Rod		
TDPR-001	1	Adjustable Panhard Rod		LHD ONLY
<b>COMPONENTS</b>				
TDUK-044	1	Front Radius Rod to Chassis		1 Kit required per vehicle
TDUK-050	1	Front Radius Rod to Diff		1 Kit required per vehicle
TDUK-043	1	Panhard Rod Bush Kit		1 Kit required per panhard rod
TDUK-1725/20	1	Urethane Spring Spacer 20mm		1 required per coil as required
TDUK-1725/30	1	Urethane Spring Spacer 30mm		1 required per coil as required
TAK-8005	1	Offset Kingpin		0.5 Degree
TAK-8075	1	Offset Kingpin		0.75 Degree
TAK-8001	1	Offset Kingpin		1.0 Degree
<b>BRAKE HOSE KITS</b>				
TDBH-003	1	Rubber Brake Hose Kit		80 & 105 Series Non ABS
TDBH-197	1	Braided Brake Hose Kit		
TDBH-300	1	Rubber Brake Hose Kit		80 Series with ABS
TDBH-200	1	Braided Brake Hose Kit		
TDBH-398	1	Rubber Brake Hose Kit		105 Series with ABS
TDBH-198	1	Braided Brake Hose Kit		

FOR REPLACEMENT BUSHING PART NUMBERS, PLEASE SEE  
PAGE (P166) PREVIOUS IN CATALOGUE

Vehicle fitment sheet must be completed when suspension fitted. Failure to do so may affect warranty.  
Fitment sheet can be found on page 200 of this catalogue

**KIT PRICING REFERENCE  
COMPONENTS AS PER IMAGE**  
*please order using part numbers*

**TOYOTA**  
**LANDCRUISER**  
1/90-07  
**80 & 105 SERIES 6" LIFT**

**REAR SUSPENSION**

PART NO.	QTY	DESCRIPTION	RRP inc GST	NOTES
<b>SHOCK ABSORBERS</b>				
BMX1111/6	2	45mm 9 Stage Adjustable Shock		Suits 150mm Lift
<b>COIL SPRINGS</b>				
TDC949/6	2	150mm Lift 0-300Kg Load		150mm Lift Spring
TDC949/6H	2	150mm Lift <b>CONSTANT 300kg</b>		150mm Lift Spring
<b>PANHARD ROD</b>				
TDPR-007	1	Adjustable Panhard Rod		
<b>COMPONENTS</b>				
TDUK-045	1	Trailing Arm Bushing Kit ( <b>Upper</b> )		1 Kit required ( <b>Upper</b> )
TDUK-046	1	Trailing Arm Bushing Kit ( <b>Lower</b> )		1 Kit required ( <b>Lower</b> )
TDUK-047	1	Panhard Rod Bush Kit		1 Kit required per panhard rod
TDUK-1724/15	1	Urethane Spring Spacer 15mm		1 per coil as required
TDUK-1724/30	1	Urethane Spring Spacer 30mm		1 per coil as required

**COMPLETE KIT PRICE REFERENCE**

SHOCK CHOICE	SPRING CHOICE	RRP inc GST	CONTENTS
45mm Big Bore 9 Stage Adjustable	ANY COIL (RHD ONLY)		 <p><b>Includes</b> 4 x Coil Springs 4 x Shocks 2 x Panhard Rods 1 x Caster Correction 1 x Brake Hoses (TDBH-003)</p>

*Freight should be added where required. When determining spring choice, include only permanent accessories & weights. Towing requirements are not included in constant load determination*

# TOYOTA

## LANDCRUISER

### 98-07

### 100 SERIES (IFS)



## FRONT SUSPENSION

**ESTIMATED LIFT: 25mm**

PART NO.	QTY	DESCRIPTION	RRP inc GST	NOTES
<b>SHOCK ABSORBERS</b>				
FC41103	2	41mm Foam Cell Shock		Up to 25mm Lift
TDR1103	2	53mm 'Ralph' Shock		Up to 25mm Lift
<b>TORSION BARS - Strengthening Bracket fitting instructions at <a href="http://toughdog.com.au">toughdog.com.au</a></b>				
4WTB-1600	1	Replacement Torsion Bars		32mm/1203mm <b>(For Petrol)</b>
4WTB-1610	1	Replacement Torsion Bars		32mm/1210mm <b>(For Diesel)</b>
4WTB-1610/BKT	1	Torsion Bar Strengthening Kit		Required with torsion bars
<b>Adjust Torsion bars after fitting shocks - Ensure a minimum of 60mm Droop is Maintained</b>				
<b>RIM TO GUARD MEASUREMENTS (Bottom of Rim to Guard)</b>				
<b>For 16" Rim</b>	<b>740mm</b>	Torsion Bars must only be adjusted so that the rim to guard measurements are not more than the measurements listed here. Lifting the vehicle higher than the specified measurement will result in the failure of front end components including shock failure.		
<b>For 17" Rim</b>	<b>753mm</b>			

## REAR SUSPENSION

<b>SHOCK ABSORBERS</b>				
FC41114	2	41mm Foam Cell Shock		Suits up to 25mm Lift
BM401114	2	40mm 9 Stage Adjustable		
BMX1114/2	2	45mm 9 Stage Adjustable Shocks		
TDR1114	2	53mm 'Ralph' Big Bore		
<b>COIL SPRINGS</b>				
TDC949HSL	2	0-300kg Load		OE Height
TDC949L	2	0-300kg Load		25mm Lift
TDC949HL	2	<b>CONSTANT</b> 300Kg Load		25mm Lift
<b>PANHARD ROD</b>				
TDPR-003	1	Adjustable Panhard Rod		
<b>COMPONENTS</b>				
TDUK-025	1	Trailing Arm Bush Kit		1 Kit required (Upper)
TDUK-026	1	Trailing Arm Bush Kit		1 Kit required (Lower)
TDUK-1724/15	1	Urethane Spring Spacer 15mm		1 per coil as required
TDUK-1724/30	1	Urethane Spring Spacer 30mm		1 per coil as required

## REPLACEMENT BUSHINGS

QUANTITY PER SHOCK				
ADJ00300/40	1	Suits Bottom Front Eying		Suits TDR Ralph Shocks Only
404454B	2	Suits Front Top Pin		Pin type bushing
404454B	1	Suits Rear Top of Top Pin		Pin type bushing
404454A	1	Suits Rear Bottom of Top Pin		Pin type bushing
415024	1	Suits Rear Bottom Eying		Eying bushing





Vehicle fitment sheet must be completed when suspension fitted. Failure to do so may affect warranty.  
Fitment sheet can be found on page 200 of this catalogue

# TOYOTA

## LANDCRUISER

98-07  
100 SERIES (IFS)

### COMPLETE KIT PRICE REFERENCE

SHOCK CHOICE	SPRING CHOICE	RRP inc GST	CONTENTS
<p><b>41mm Foam Cell</b></p> <p><u>Includes</u> 2 x Coil Springs 4 x Shocks 1x Torsion Bar Strengthening Bracket</p>	<p>\$ 135 Coil</p> <p>\$ 175 Coil</p>		
<p><b>Foam Cell Front Adjustable Rear</b></p> <p><u>Includes</u> 2 x Coil Springs 4 x Shocks 1x Torsion Bar Strengthening Bracket</p>	<p>\$ 135 Coil</p> <p>\$ 175 Coil</p>		
<p><b>53mm 'Ralph' Front 45mm Adjustable Rear</b></p> <p><u>Includes</u> 2 x Coil Springs 4 x Shocks 1x Torsion Bar Strengthening Bracket</p>	<p>\$ 135 Coil</p> <p>\$ 175 Coil</p>		
<p><b>53mm 'Ralph' Big Bore</b></p> <p><u>Includes</u> 2 x Coil Springs 4 x Shocks 1x Torsion Bar Strengthening Bracket</p>	<p>\$ 135 Coil</p> <p>\$ 175 Coil</p>		

Freight should be added where required. When determining spring choice, include only permanent accessories & weights. Towing requirements are not included in constant load determination

# TOYOTA

## LANDCRUISER

11/07 On  
200 Series



### FRONT SUSPENSION

**ESTIMATED LIFT: 40mm**

PART NO.	QTY	DESCRIPTION	RRP inc GST	NOTES
<b>SHOCK ABSORBERS</b>				
FC404900	2	40mm Foam Cell Strut		
BM404900	2	40mm Adjustable Strut		9 Stage Adjustable
BMX454900	2	45mm Adjustable Strut		<b>Does not suit factory coils</b>
<b>COIL SPRINGS</b>				
TDC930SL	2	OE Height Spring		OE Height Spring
TDC930HSL	2	OE Height Spring Bar & Winch		OE Height Spring
TDC930L	2	40mm Lift Spring		With Bar (excl. Sahara)
TDC930HL	2	40mm Lift Spring		With Bar & Winch (incl all Sahara)
TDC932L	2	40mm Lift Spring- <b>BMX strut only</b>		With Bar (OE height for Sahara)
TDC932HL	2	40mm Lift Spring- <b>BMX strut only</b>		With Bar & Winch (incl all Sahara)
<b>COMPLETE STRUT ASSEMBLY</b>				
TOY-200/01	2	BM404900/TDC930L		Petrol/Diesel With Bar
TOY-200/02	2	BM404900/TDC930HL		Petrol/Diesel with Bar & Winch
TOY-200/04	2	FC404900/TDC930L		Petrol/Diesel With Bar
TOY-200/05	2	FC404900/TDC930HL		Petrol/Diesel with Bar & Winch
TOY-200/07	2	BMX454900/TDC932L <b>(45mm)</b>		Petrol/Diesel With Bar
TOY-200/08	2	BMX454900/TDC932HL <b>(45mm)</b>		Petrol/Diesel with Bar & Winch
<b>REPLACEMENT STRUT TOP</b>				
TOY-1020	2	Strut Top		Replacement Strut Top

### REAR SUSPENSION

**ESTIMATED LIFT: 20mm**

<b>SHOCK ABSORBERS</b>				
FC41114	2	41mm Foam Cell Shock		Up to 20mm Lift
BM401114	2	40mm 9 Stage Adjustable		Up to 20mm Lift
BMX1114/2	2	45mm 9 Stage Adjustable		Up to 20mm Lift
TDR1114	2	53mm Big Bore 'Ralph'		Up to 20mm Lift
<b>COIL SPRINGS</b>				
TDC931L	2	0-300kg Load		20mm Lift
TDC931HL	2	<b>CONSTANT</b> 300Kg Load		20mm Lift
TDC931VHL	2	<b>CONSTANT</b> 500Kg Load		20mm Lift
<b>PANHARD ROD</b>				
TDPR-200	2	Adjustable Panhard Rod		
TDSB-006	1	33mm H/D Sway Bar Kit		Suit Non-KDSS only
<b>AIR ASSIST BAGS</b>				
TDAA-010	1	Coil insert bag kit		Suits up to 25mm Lift

### REPLACEMENT BUSHINGS

QUANTITY PER SHOCK				
TOY-1020	1	Replacement Strut Top		Available As Complete Unit Only
4WAY-001	1	Suits Bottom Front Eying		Eying Bonded Bushing
404454B + 404454A	1 (ea)	Suits Rear Top Pin		Eying Bushing
415024	1	Suits Rear Bottom Eying		

**Note: Vehicles fitted with KDSS require a specific fitment procedure to be followed to avoid failure.**

**Instructions available at [toughdog.com.au](http://toughdog.com.au)**

# TOYOTA LANDCRUISER 11/07 On 200 Series

## COMPLETE KIT PRICE REFERENCE

SHOCK CHOICE	SPRING CHOICE	RRP inc GST	CONTENTS
<b>Foam Cell</b> <b>Struts Require Assembly</b> Includes 4 x Coil Springs 4 x Shocks	\$135 Rear Coils  \$175 Rear Coils		
<b>Foam Cell Complete Assembly Struts</b> Includes 2 x Front Strut Assy 2 x Coil Springs 2 x Rear Shocks	\$135 Rear Coils  \$175 Rear Coils		
<b>40mm Adjustable</b> <b>Struts Require Assembly</b> Includes 4 x Coil Springs 4 x Shocks	\$135 Rear Coils  \$175 Rear Coils		
<b>40mm Adjustable Complete Assembly Struts</b> Includes 2 x Front Strut Assy 2 x Coil Springs 2 x Rear Shocks	\$135 Rear Coils  \$175 Rear Coils		
<b>45mm Adjustable</b> <b>Struts Require Assembly</b> Includes 4 x Coil Springs 4 x Shocks	\$135 Rear Coils  \$175 Rear Coils		
<b>45mm Adjustable Complete Assembly Struts</b> Includes 2 x Front Strut Assy 2 x Coil Springs 2 x Rear Shocks	\$135 Rear Coils  \$175 Rear Coils		

Freight should be added where required. When determining spring choice, include only permanent accessories & weights. Towing requirements are not included in constant load determination

# TOYOTA

## PRADO

7/96-03

95 SERIES



### FRONT SUSPENSION

**ESTIMATED LIFT: 40mm**

PART NO.	QTY	DESCRIPTION	RRP inc GST	NOTES
<b>SHOCK ABSORBERS</b>				
FC404100	2	40mm Foam Cell Strut		
BM404100	2	40mm Adjustable Strut		9 Stage Adjustable
<b>COIL SPRINGS</b>				
TDC971S	2	25mm Lift Spring		
TDC971	2	40mm Lift Spring		Petrol/Diesel/Bar
TDC971H	2	40mm Lift Spring		Petrol/Diesel/Bar/Winch
<b>COMPLETE STRUT ASSEMBLY</b>				
TOY-095/01	2	BM404100/TDC971		All with/Diesel/Bar
TOY-095/02	2	BM404100/TDC971H		All with/Diesel/Bar/Winch
TOY-095/03	2	FC404100/TDC971		All with/Diesel/Bar
TOY-095/04	2	FC404100/TDC971H		All with/Diesel/Bar/Winch
TOY-095/05	2	FC404100/TDC971S		All with/Diesel (OE Height)
TOY-095/06	2	BM404100/TDC971S		All with/Bar(OE Height)
<b>REPLACEMENT STRUT ASSEMBLY</b>				
TOY-1081	2	Strut Top		Replacement Strut Top

### REAR SUSPENSION

<b>SHOCK ABSORBERS</b>				
FC41108	2	41mm Foam Cell Shock		OE Height
BM401108	2	40mm 9 Stage Adjustable		
FC41113	2	41mm Foam Cell Shock		40mm Lift
BM401113	2	40mm 9 Stage Adjustable		
<b>COIL SPRINGS</b>				
TDC973S	2	0-300kg Load		25mm Lift
TDC973	2	0-300kg Load		40mm Lift
TDC973H	2	<b>CONSTANT</b> 300Kg Load		40mm Lift





### REPLACEMENT BUSHINGS

QUANTITY PER SHOCK				
TOY-1081	1	Replacement Strut Top		Available As Complete Unit Only
ADJ00300/40	1	Suits Bottom Front Eying		Eying Bonded Bushing
TW959	2	Suits Top Rear Pin Mount		Pin Style Bushing
ADJ00191	1	Suits Rear Bottom Eying		Eying Bushing

Vehicle fitment sheet must be completed when suspension fitted. Failure to do so may affect warranty.  
Fitment sheet can be found on page 200 of this catalogue

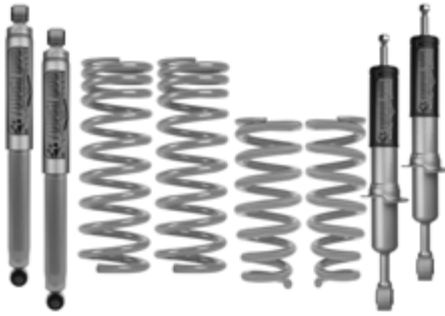

### COMPLETE KIT PRICE REFERENCE

SHOCK CHOICE	SPRING CHOICE	RRP inc GST	CONTENTS
<p><b>Foam Cell Struts Require Assembly</b> Includes 4 x Coil Springs 4 x Shocks</p>	ANY		
<p><b>Foam Cell Complete Assembly Struts</b> Includes 2 x Front Strut Assy 2 x Coil Springs 2 x Rear Shocks</p>	ANY		
<p><b>40mm Adjustable Struts Require Assembly</b> Includes 4 x Coil Springs 4 x Shocks</p>	ANY		
<p><b>40mm Adjustable Complete Assembly Struts</b> Includes 2 x Front Strut Assy 2 x Coil Springs 2 x Rear Shocks</p>	ANY		

Freight should be added where required. When determining spring choice, include only permanent accessories & weights. Towing requirements are not included in constant load determination

# TOYOTA

## PRADO

2/03-10

120 SERIES LWB & SWB



### FRONT SUSPENSION

**ESTIMATED LIFT: 40mm**

PART NO.	QTY	DESCRIPTION	RRP inc GST	NOTES
<b>SHOCK ABSORBERS</b>				
FC404400	2	40mm Foam Cell Strut		
BM404400	2	40mm Adjustable Strut		9 Stage Adjustable
<b>COIL SPRINGS - Please check LWB/SWB prior to ordering</b>				
TDC974S	2	OE Height Spring		Petrol/Diesel/Bar
TDC974	2	40mm Lift Spring		Petrol/Diesel/Bar
TDC974H	2	40mm Lift Spring		Petrol/Diesel/Bar/Winch
<b>COMPLETE STRUT ASSEMBLY - Please check LWB/SWB prior to ordering</b>				
TOY-120/01	2	BM404400/TDC974		All With Bar
TOY-120/02	2	BM404400/TDC974H		All With Bar/Winch
TOY-120/03	2	FC404400/TDC974		All With Bar
TOY-120/04	2	FC404400/TDC974H		All With Bar/Winch
TOY-120/07	2	FC404400/TDC974S		All With Bar <b>(OE Height)</b>
TOY-120/08	2	BM404400/TDC974S		All With Bar/Winch <b>(OE Height)</b>
<b>REPLACEMENT STRUT ASSEMBLY</b>				
TOY-1084	2	Strut Top		Replacement Strut Top
<b>COMPONENTS</b>				
TDSP-011	1	Sway Bar Spacer Kit		76mm hole spacing

### REAR SUSPENSION

<b>SHOCK ABSORBERS</b>				
FC41116	2	41mm Foam Cell Shock		40mm Lift
BM401116	2	40mm 9 Stage Adjustable		
<b>COIL SPRINGS - Please check LWB/SWB prior to ordering</b>				
TDC975S	2	0-300kg Load		OE Height - <b>Suit LWB</b>
TDC975	2	0-300kg Load		40mm Lift - <b>Suit LWB</b>
TDC975H	2	<b>CONSTANT</b> 300Kg Load		40mm Lift - <b>Suit LWB</b>
TDC975S	2	0-300kg Load		40mm Lift - <b>Suit SWB</b>
TDC975	2	<b>CONSTANT</b> 300Kg Load		40mm Lift - <b>Suit SWB</b>
TDC975AB	2	0-300kg Load		40mm Lift - <b>Airbag Conversion</b>
TDC975HAB	2	<b>CONSTANT</b> 300Kg Load		40mm Lift - <b>Airbag Conversion</b>
<b>AIR ASSIST BAGS</b>				
TDAA-009	1	Coil insert bag kit		Suits up to 40 mm Lift

**Air Assist bags are coil insert only and do not suit as OEM airbag replacements**

### REPLACEMENT BUSHINGS

<b>QUANTITY PER SHOCK</b>				
TOY-1084	1	Replacement Strut Top		Available As Complete Unit Only
ADJ00300/40	1	Suits Bottom Front Eying		Eying Bonded Bushing
TW967	2	Suits Top Rear Pin Mount		Pin Style Bushing
415024	1	Suits Rear Bottom Eying		Eying Bushing

Vehicle fitment sheet must be completed when suspension fitted. Failure to do so may affect warranty.

Fitment sheet can be found on page 200 of this catalogue





# TOYOTA

PRADO

2/03-2010

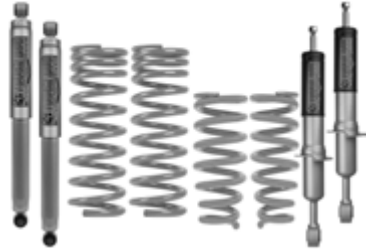
120 SERIES LWB & SWB

## COMPLETE KIT PRICE REFERENCE

SHOCK CHOICE	SPRING CHOICE	RRP inc GST	CONTENTS
<b>Foam Cell Struts Require Assembly</b> <b>Includes</b> 4 x Coil Springs 4 x Shocks 1 x Sway Bar Spacer	ANY		
<b>Foam Cell Complete Assembly Struts</b> <b>Includes</b> 2 x Front Strut Assy 2 x Coil Springs 2 x Rear Shocks 1 x Sway Bar Spacer	ANY		
<b>40mm Adjustable Struts Require Assembly</b> <b>Includes</b> 4 x Coil Springs 4 x Shocks 1 x Sway Bar Spacer	ANY		
<b>40mm Adjustable Complete Assembly Struts</b> <b>Includes</b> 2 x Front Strut Assy 2 x Coil Springs 2 x Rear Shocks 1 x Sway Bar Spacer	ANY		

## OEM AIRBAG VEHICLES

### NOTES ON CONVERSION (Replacing Dampers only)

The electronically controlled dampers on 120 series prado can be replaced with Tough Dog shock absorbers without error indicators appearing on the instrument cluster.

**It is imperative that all four shock absorbers are replaced at the same time.**

If operating correctly, the electronically adjustable height control of the rear air springs will not be affected if all four dampers are replaced at the same time.

### NOTES ON CONVERSION (Replacing airbags & Dampers)

When converting from air springs to conventional coils at the rear of prado 120 series, the electronic workaround detailed in the instructions provided with the rear springs prevents the error indicator from being displayed in the instrument cluster.

The electronic workaround will also disable the electronic damping system, it is therefore important that all four dampers must be replaced if the air bag system is converted to coil springs.

**Toyota Genuine Bumpstop part number 48302-35040 spring seat sub assembly should be orderd through Toyota**

Freight should be added where required. When determining spring choice, include only permanent accessories & weights. Towing requirements are not included in constant load determination

# TOYOTA

## PRADO

2010 On

150 SERIES LWB & SWB



### FRONT SUSPENSION

**ESTIMATED LIFT: 40mm**

PART NO.	QTY	DESCRIPTION	RRP inc GST	NOTES
<b>SHOCK ABSORBERS</b>				
FC404400	2	40mm Foam Cell Strut		
BM404400	2	40mm Adjustable Strut		9 Stage Adjustable
<b>COIL SPRINGS - Please check LWB/SWB prior to ordering</b>				
TDC974H	2	40mm Lift Spring		Suits with Bar - <b>Suit LWB</b>
TDC974HH	2	40mm Lift Spring		Suits with Bar & Winch - <b>Suit LWB</b>
TDC974S	2	40mm Lift Spring		Suits with Bar - <b>Suit SWB</b>
TDC974	2	40mm Lift Spring		Suits with Bar & Winch - <b>Suit SWB</b>
<b>COMPLETE STRUT ASSEMBLY - Please check LWB/SWB prior to ordering</b>				
TOY-150/03	2	BM404400/TDC974H		All with Bar - <b>Suit LWB</b>
TOY-150/04	2	BM404400/TDC974HH		All with Bar & Winch - <b>Suit LWB</b>
TOY-150/07	2	FC404400/TDC974H		All with Bar - <b>Suit LWB</b>
TOY-150/08	2	FC404400/TDC974HH		All with Bar & Winch - <b>Suit LWB</b>
TOY-150/01	2	BM404400/TDC974S		All with Bar - <b>Suit SWB</b>
TOY-150/02	2	BM404400/TDC974		All with Bar & Winch - <b>Suit SWB</b>
TOY-150/05	2	FC404400/TDC974S		All with Bar - <b>Suit SWB</b>
TOY-150/06	2	FC404400/TDC974		All with Bar & Winch - <b>Suit SWB</b>
<b>REPLACEMENT STRUT ASSEMBLY</b>				
TOY-1083	2	Strut Top		Replacement Strut Top
<b>COMPONENTS</b>				
TDSP-012	1	Sway Bar Spacer Kit		83mm hole spacing

### REAR SUSPENSION

<b>SHOCK ABSORBERS</b>				
FC41118	2	41mm Foam Cell Shock		40mm Lift
BM401118	2	40mm 9 Stage Adjustable		
<b>COIL SPRINGS - Please check LWB/SWB prior to ordering</b>				
TDC975S	2	0-300kg Load		OE Height - <b>Suit LWB</b>
TDC975	2	0-300kg Load		40mm Lift - <b>Suit LWB</b>
TDC975H	2	<b>CONSTANT</b> 300Kg Load		40mm Lift - <b>Suit LWB</b>
TDC975S	2	0-300kg Load		40mm Lift - <b>Suit SWB</b>
TDC975	2	<b>CONSTANT</b> 300Kg Load		40mm Lift - <b>Suit SWB</b>
<b>AIR ASSIST BAGS</b>				
TDAA-009	1	Coil insert bag kit		Suits up to 40 mm Lift

### REPLACEMENT BUSHINGS

QUANTITY PER SHOCK				
TOY-1083	1	Replacement Strut Top		Available As Complete Unit Only
ADJ00300/40	1	Suits Bottom Front Eying		Eying Bonded Bushing
TW967	2	Suits Top Rear Pin Mount		Pin Style Bushing
415024	1	Suits Rear Bottom Eying		Eying Bushing

Vehicle fitment sheet must be completed when suspension fitted. Failure to do so may affect warranty.

Fitment sheet can be found on page 200 of this catalogue

# TOYOTA

PRADO

2010 On

150 SERIES LWB & SWB

## COMPLETE KIT PRICE REFERENCE

SHOCK CHOICE	SPRING CHOICE	RRP inc GST	CONTENTS
<p><b>Foam Cell Struts Require Assembly</b> Includes 4 x Coil Springs 4 x Shocks 1 x Sway Bar Spacer</p>	ANY		
<p><b>Foam Cell Complete Assembly Struts</b> Includes 2 x Front Strut Assy 2 x Coil Springs 2 x Rear Shocks 1 x Sway Bar Spacer</p>	ANY		
<p><b>40mm Adjustable Struts Require Assembly</b> Includes 4 x Coil Springs 4 x Shocks 1 x Sway Bar Spacer</p>	ANY		
<p><b>40mm Adjustable Complete Assembly Struts</b> Includes 2 x Front Strut Assy 2 x Coil Springs 2 x Rear Shocks 1 x Sway Bar Spacer</p>	ANY		

Freight should be added where required. When determining spring choice, include only permanent accessories & weights. Towing requirements are not included in constant load determination

# TOYOTA

## FJ CRUISER

06 On

All Models



### FRONT SUSPENSION

**ESTIMATED LIFT: 40mm**

PART NO.	QTY	DESCRIPTION	RRP inc GST	NOTES
<b>SHOCK ABSORBERS</b>				
FC404400	2	40mm Foam Cell Strut		
BM404400	2	40mm Adjustable Strut		9 Stage Adjustable
<b>COIL SPRINGS</b>				
TDC974H	2	40mm Lift Spring		Suits with Bar
TDC974HH	2	40mm Lift Spring		Suits with Bar & Winch
<b>COMPLETE STRUT ASSEMBLY</b>				
TOY-150/03	2	BM404400/TDC974H		All with Bar
TOY-150/04	2	BM404400/TDC974HH		All with Bar & Winch
TOY-150/07	2	FC404400/TDC974H		All with Bar
TOY-150/08	2	FC404400/TDC974HH		All with Bar & Winch
<b>REPLACEMENT STRUT ASSEMBLY</b>				
TOY-1083	2	Strut Top		Replacement Strut Top
<b>COMPONENTS</b>				
TDSP-011	1	Sway Bar Spacer Kit		76mm spacing - 06-2009 vehicles
TDSP-012	1	Sway Bar Spacer Kit		83mm spacing - 2010 on vehicles
<b>Check hole spacing of sway bar mounting locations to ensure the correct kit is ordered.</b>				

### REAR SUSPENSION

<b>SHOCK ABSORBERS</b>				
FC41116	2	41mm Foam Cell Shock		40mm Lift
BM401116	2	40mm 9 Stage Adjustable		
<b>COIL SPRINGS</b>				
TDC975	2	0-300kg Load		40mm Lift
TDC975H	2	<b>CONSTANT</b> 300Kg Load		40mm Lift
<b>AIR ASSIST BAGS</b>				
TDAA-009	1	Coil insert bag kit		Suits up to 40 mm Lift

### REPLACEMENT BUSHINGS

QUANTITY PER SHOCK				
TOY-1083	1	Replacement Strut Top		Available As Complete Unit Only
ADJ00300/40	1	Suits Bottom Front Eying		Eying Bonded Bushing
TW967	2	Suits Top Rear Pin Mount		Pin Style Bushing
415024	1	Suits Rear Bottom Eying		Eying Bushing





Vehicle fitment sheet must be completed when suspension fitted. Failure to do so may affect warranty.  
Fitment sheet can be found on page 200 of this catalogue

# TOYOTA

## FJ CRUISER

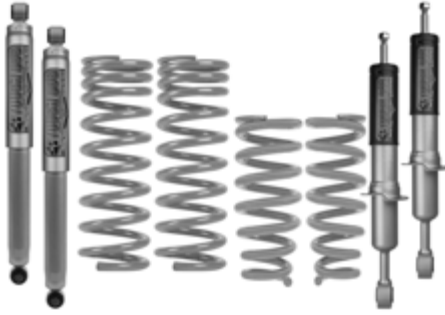
06 On

### COMPLETE KIT PRICE REFERENCE

SHOCK CHOICE	SPRING CHOICE	RRP inc GST	CONTENTS
<p><b>Foam Cell Struts Require Assembly</b></p> <p><u>Includes</u>            4 x Coil Springs            4 x Shocks            1 x Sway Bar Spacer</p>	ANY		
<p><b>Foam Cell Complete Assembly Struts</b></p> <p><u>Includes</u>            2 x Front Strut Assy            2 x Coil Springs            2 x Rear Shocks            1 x Sway Bar Spacer</p>	ANY		
<p><b>40mm Adjustable Struts Require Assembly</b></p> <p><u>Includes</u>            4 x Coil Springs            4 x Shocks            1 x Sway Bar Spacer</p>	ANY		
<p><b>40mm Adjustable Complete Assembly Struts</b></p> <p><u>Includes</u>            2 x Front Strut Assy            2 x Coil Springs            2 x Rear Shocks            1 x Sway Bar Spacer</p>	ANY		

Freight should be added where required. When determining spring choice, include only permanent accessories & weights. Towing requirements are not included in constant load determination

# TOYOTA

**RAV 4**  
**5/94-00**  
**SAX 10, 11**



## FRONT SUSPENSION

**ESTIMATED LIFT: 30mm**

PART NO.	QTY	DESCRIPTION	RRP inc GST	NOTES
<b>SHOCK ABSORBERS</b>				
BDS4001	2	Nitrogen gas Strut Insert		Suits up to 30mm Lift
<b>COIL SPRINGS</b>				
TDC981	2	30mm Lift Spring		

## REAR SUSPENSION

<b>SHOCK ABSORBERS</b>				
BD1106TB	2	35mm Nitr Gas Shocks		Suits up to 30mm Lift
BM401106	2	40mm 9 Stage Adjustable		
<b>COIL SPRINGS</b>				
TDC982	2	0-300kg Load		30mm Lift Spring

## REPLACEMENT BUSHINGS

QUANTITY PER SHOCK				
TW959	2	Suits Top Rear Pin Mount		Pin Style Bushing
ADJ00191	1	Suits Rear Bottom Eying		Eying Bushing

## COMPLETE KIT PRICE REFERENCE

SHOCK CHOICE	SPRING CHOICE	RRP inc GST	CONTENTS
35mm Nitro Gas	ANY COIL		
Nitro Gas Front Adjustable Rear	ANY COIL		
<b>Includes</b> 4 x Coil Springs    2 x Shocks 2 x Front strut inserts			

Vehicle fitment sheet must be completed when suspension fitted. Failure to do so may affect warranty.  
 Fitment sheet can be found on page 200 of this catalogue





# TOYOTA

## TUNDRA

03/07 On  
UCK, UPK, USK 55, 56

### FRONT SUSPENSION

**ESTIMATED LIFT: 45mm**

PART NO.	QTY	DESCRIPTION	RRP inc GST	NOTES
<b>SHOCK ABSORBERS</b>				
FC404910	2	40mm Foam Cell Strut		Suits up to 45m Lift
BM404910	2	40mm Adjustable Strut		Suits up to 45m Lift
<b>COIL SPRINGS</b>				
TDC930L	2	45mm Lift Spring		Suits with Alloy Bar
TDC930HL	2	45mm Lift Spring		Suits with Bar/Winch

### REAR SUSPENSION

<b>SHOCK ABSORBERS</b>				
FC41117	2	41mm Foam Cell Shocks		Suits 45mm Lift
BM401117	2	40mm Adjustable Shocks		
<b>LEAF SPRINGS</b>				
FS701	2	0-300kg Load 45mm Lift Spring		Includes bushings in spring
<b>COMPONENTS</b>				
TDUK-074	1	Urethane Shackle Bushing Kit		Not required if ordering FS701
TDUK-076	1	Urethane Chassis Bush Only		Required for lift kit
TDUB-016HD	2	U-Bolt Kit		

### COMPLETE KIT PRICE REFERENCE

SHOCK CHOICE	SPRING CHOICE	RRP inc GST	CONTENTS
41mm Foam Cell	0-300KG		
40mm Adjustable	0-300KG		
<b>Includes</b> 2 x Coil Springs    2 x Shocks    2 x Front struts 1 x Urethane Bushes (TDUK-076)    2 x U-Bolt Kits			

Freight should be added where required. When determining spring choice, include only permanent accessories & weights. Towing requirements are not included in constant load determination

# UAZ

## ALL MODELS

1965 On

UAZ, HUNTER, PATRIOT



### FRONT SUSPENSION

**ESTIMATED LIFT: 40mm**

PART NO.	QTY	DESCRIPTION	RRP inc GST	NOTES
<b>SHOCK ABSORBERS</b>				
FC41382	2	41mm Foam Cell Shock		Suits UAZ 452 (65-72), UAZ 469 (72-85) & UAZ 3151 (85-03)
BM401382	2	40mm Adjustable Shock		
FC41391	2	41mm Foam Cell Shock		Suits Hunter (2003 On)
BM401391	2	40mm Adjustable Shock		
FC41150	2	41mm Foam Cell Shock		Suits Patriot (2005 On)
BM401150	2	40mm Adjustable Shock		
<b>COIL SPRINGS</b>				
TDC150SL	2	OE Height Spring		
TDC150L	2	40mm Lift Spring		Suits with Bar
TDC150HL	2	40mm Lift Spring		Suits with Bar & Winch

### REAR SUSPENSION

<b>SHOCK ABSORBERS</b>				
FC41382	2	41mm Foam Cell Shock		Suits UAZ 452 (65-72), UAZ 469 (72-85) & UAZ 3151 (85-03)
BM401382	2	40mm Adjustable Shock		
FC41389	2	41mm Foam Cell Shock		Suits Hunter (2003 On)
BM401389	2	40mm Adjustable Shock		
FC41389	2	41mm Foam Cell Shock		Suits Patriot (2005 On)
BM401389	2	40mm Adjustable Shock		
<b>LEAF SPRINGS</b>				
FS160H	2	0-300Kg Load		40mm Lift Spring
FS160HH	2	<b>CONSTANT</b> 400Kg Load		40mm Lift Spring

Vehicle fitment sheet must be completed when suspension fitted. Failure to do so may affect warranty.

Fitment sheet can be found on page 200 of this catalogue



# VOLKSWAGEN

**AMAROK**  
10 On  
All Models

**ESTIMATED LIFT: 20mm**

PART NO.	QTY	DESCRIPTION	RRP inc GST	NOTES
<b>SHOCK ABSORBERS</b>				
FC404730	2	40mm Foam Cell Strut		<b>Not suitable with OE Coils</b>
BM404730	2	40mm Adjustable Strut		<b>Not suitable with OE Coils</b>
<b>COIL SPRINGS - Suits 2.0L Engine Only</b>				
TDC110SL	2	OE Height Spring		
TDC110L	2	20mm Lift Spring		Suits with Bar
TDC110HL	2	20mm Lift Spring		Suits with Bar & Winch
<b>Complete assembly not available for this vehicle. Please visit <a href="http://www.toughdog.com.au">www.toughdog.com.au</a> for installation video</b>				
<b>COIL SPRINGS - Suits 3.0L V6 Engine Only</b>				
TDC120L	2	20mm Lift Spring		Suits with Bar
TDC120HL	2	20mm Lift Spring		Suits with Bar & Winch

## REAR SUSPENSION

<b>SHOCK ABSORBERS</b>				
FC41390	2	41mm Foam Cell Shocks		Up to 20mm Lift
BM401390	2	40mm 9 Stage Adjustable Shock		Up to 20mm Lift
<b>LEAF SPRINGS</b>				
FS710M	2	0-300Kg Load		20mm Lift Spring
FS710HM	2	<b>CONSTANT</b> 300Kg Load		20mm Lift Spring
<b>COMPONENTS</b>				
TDUK-072	1	Urethane Bushing Kit (Leaf)		included in kit pricing
TDUK-075	1	Urethane Bushing Kit (Chassis)		not included in kit pricing (order separately if needed)
<b>Amarok chassis bush has two thicknesses - TDUK-075 includes both sizes - please use correct set.</b>				
TDUB-005	2	U-Bolt Kit		
<b>AIR ASSIST BAGS</b>				
TDAA-114	1	Bellows bag kit		Suits up to 20 mm Lift

## COMPLETE KIT PRICE REFERENCE

SHOCK CHOICE	SPRING CHOICE	RRP inc GST	CONTENTS
41mm Foam Cell	0-300kg		
	CONSTANT 300KG		
9 Stage Adjustable	0-300kg		
	CONSTANT 300KG		
<b>Includes</b> 2 x Coil Springs      4 x Shocks    2 x Leaf Springs 1 x Urethane Kit (TDUK-072)      2 x U-Bolt Kits			

Freight should be added where required. When determining spring choice, include only permanent accessories & weights. Towing requirements are not included in constant load determination

# FITTING SHEET

## ESSENTIAL BEFORE & AFTER MEASUREMENTS

**PLEASE COMPLETE THIS FORM BEFORE ANY FITMENT**

*Please File this form with your vehicle service records for reference. Failure to complete this form or may delay resolution of issues.*

CUSTOMER DETAILS			
Fitted By:		Date	
Owner's Name		Year	
Address		Make	
Suburb	P'Code	Model	
Phone Number		Odometer:	
Email:		Comments:	

*Measurements should be taken from the bottom of the rim to the wheel arch on each corner. In the case of a tray, measure to the same point each time*

BEFORE & AFTER MEASUREMENTS	AFTERMARKET FITMENTS	BEFORE & AFTER MEASUREMENTS
-----------------------------	----------------------	-----------------------------

PASSENGER FRONT SIDE	
Original Height	
Height After Lift	
Height 500km Service	
Shock Fitted (P/N)	
Spring Fitted (P/N)	
Comments	

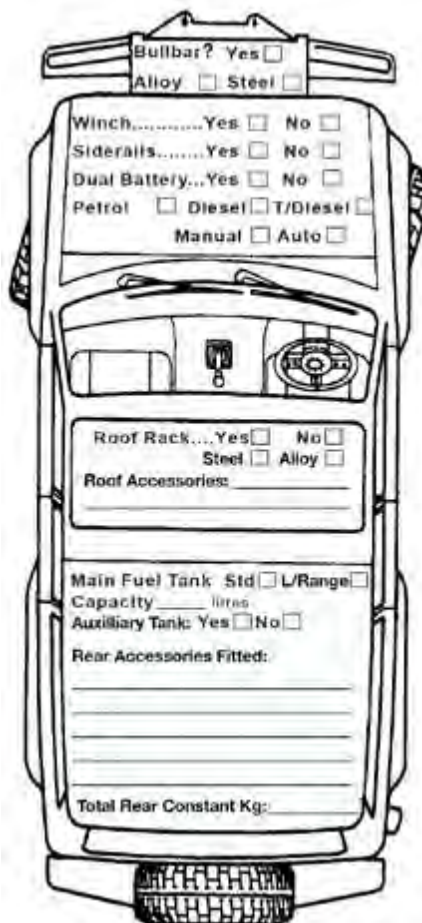

DRIVERS FRONT SIDE	
Original Height	
Height After Lift	
Height 500km Service	
Shock Fitted (P/N)	
Spring Fitted (P/N)	
Comments	

PASSENGER REAR SIDE	
Original Height	
Height After Lift	
Height 500km Service	
Shock Fitted (P/N)	
Spring Fitted (P/N)	
Comments	

DRIVERS REAR SIDE	
Original Height	
Height After Lift	
Height 500km Service	
Shock Fitted (P/N)	
Spring Fitted (P/N)	
Comments	

*Vehicle fitment sheet must be completed when suspension fitted. Failure to do so may affect warranty.  
Fitment sheet can be found on page 200 of this catalogue*



# DISCLAIMER FORM

## VEHICLES LIFTED MORE THAN 50MM

**Vehicles fitted with a lift kit greater than 50mm over Original Equipment height may not be suitable for on road use. Consult your local Authority or a Qualified Engineer**

CUSTOMER DETAILS			
Rego No:		Date	
Owner's Name		Year	
Address		Make	
Suburb		P'Code	
Phone Number		Model	
Email:		Odometer:	
		Comments:	

### Declaration

The suspension components fitted to this vehicle (Registration \_\_\_\_\_) are suitable for off-road use only and may not comply with the requirements of registration. Operation of this vehicle on a road or road related area is done so at the operator's own risk.

Compliance with the requirements of registration is the responsibility of the owner of the vehicle and no liability shall be accepted by any other person. Compliance of the vehicle can be undertaken with the assistance of a qualified certifying Engineer.

Schedule of Parts Fitted		
	FRONT	REAR
Shock Absorbers		
Coil Springs		
Steering Stabilizer		
Panhard Rods		
Castor Bushes/Plates		
Transmission Spacers		
Brake Hoses		

Signed: \_\_\_\_\_

Date: \_\_\_\_\_

Name (Print) \_\_\_\_\_

### Disclaimer

4Way Suspension Products Pty Ltd markets a range of off road products that may require certification from a qualified engineer prior to driving on public roads. The fitment of these items and the operation of the vehicle on public roads or road related areas prior to certification may render the vehicle unroadworthy, and may affect the status of your registration. Please check with the relevant ADR authorities in your state or territory and a qualified Engineer. Details of suitable Engineers are provided by the state/territory authority.

*Vehicle fitment sheet must be completed when suspension fitted. Failure to do so may affect warranty.*

*Fitment sheet can be found on page 200 of this catalogue*

# VEHICLE WEIGHT

## GVM & RELATED INFORMATION

### GVM - WHAT IT MEANS TO YOU

The GVM, or Gross Vehicle Mass of any vehicle is the weight in Kg that the manufacturer has specified as being the maximum that the vehicle can weigh when fully loaded.

Exceeding the GVM (overloading the vehicle) can result in premature failure of a range of parts, including structural failure of the chassis.



### ACCESSORIES & GVM

When calculating how much load you are able to carry in your vehicle, remember to consider the weight of the accessories fitted. Accessories fitted add to the weight of the car, and reduces the allowable load that the vehicle can carry. These can include:

- Bullbar
- Winch
- Dual Batteries
- Underbody protection plates
- Sidesteps and scrub bars
- Long Range Fuel Tank(s)
- Draw Systems
- Rear bars
- Canopies
- Roof rack & accessories

After adding passengers, fuel, food and water, the vehicle must remain under the specified GVM from the manufacturer to avoid potentially dangerous & expensive vehicle damage and/or component failure. Consideration should be given towards the purchase of an offroad trailer.

Failure to observe the legal GVM of your vehicle is irresponsible and illegal. This may result in legal ramifications including fines and registration. Licence cancellation as well as void insurance in the event of an accident. Vehicles operating above GVM are operating outside the tested and warrantable parameter of the suspension, and are therefore not covered by 4Way Suspension Product Warranty

**SAFETY FIRST,  
NEVER OVERLOAD  
YOUR VEHICLE!**

*Freight should be added where required. When determining spring choice, include only permanent accessories & weights. Towing requirements are not included in constant load determination*