

PARTS CATALOGUE
VER. 7
Q1 2020

WWW.TOUGHDOG.COM.AU

TABLE OF CONTENTS

Version 7 - Q1 2020

Unless specified otherwise, all listings in this catalogue are for 4WD (Four Wheel Drive) vehicles only.

LIMITED WARRANTY		
TERMS & CONDITIONS	5	
PURCHASE ORDER FORM		
ROCK DOG		
SLOW SPEED COMPETITION USE ONLY	7	
RECOVERY GEAR		
RECOVERY EQUIPMENT	8	
ASIA MOTORS		
ROCSTA		
AM102	10	
DAEWOO		
MUSSO	11	
DAIHATSU		
F10 F20, F50, F60		
INCLUDING SCAT	12	
F25, F55, F65		
FEROZA		
CX12, F300	14	
FEROZA II		
F310	15	
ROCKY		
6/84-89 - F80, F85	16	
F77, F87 PICKUP & TRAYBACK	17	
F73, F78 (COIL SPRINGS)	18	
DODGE		
RAM		
1500 SERIES	19	
FORD		
EVEREST		
UA1 Models	20	
UA2 Models	21	
EXPLORER		
UN, UP, UQ	22	
BRONCO		
Third Generation	22	
F250		
Live Axle Front, Quad Rear Shocks	23	
COURIER		
PC, PD, PE, PG, PH	24	
RANGER		
PJ & PK, 2.5L & 3.0L	25	
PX & PX II- All Models	26	
PXIII All Models	28	
PXIII RAPTOR MODELS ONLY	30	
GREAT WALL		
UTE (WINGLE, SAILOR)		
V200, V240, 2.4L, 2.0L	31	
4 DOOR (HOVER, SAFE, HAVAL)		
X240, X200, 2.4L, 2.0L	32	
MB & MX 2 DOOR & 4 DOOR, 3.2L V6, 2.2L TDI	33	
HOLDEN		
FRONTERA LWB & SWB		
JACKAROO, ISUZU TROOPER		
UBS13, 16, 52, 52L	34	
UBS16, 17, 52, 55	35	
JACKAROO, MONTEREY		
UBS 25, 26, 69, 73 (INC WIDE BODY)	36	
KB4, KBD4	37	
RODEO		
TFS17, 54,55, (G1,G3,G6,R7) TFS25, 77 (R9)	38	
RODEO & COLORADO		
RA-RC	40	
COLORADO		
RG, MMU142, GM1700	42	
COLORADO 7/TRAILBLAZER		
ALL MODELS	44	
HYUNDAI		
TERRACAN		
HP	45	
ISUZU		
D-MAX		
MY09-MY11	46	
TFS85, V-CROSS, MY12	48	
MU-X		
MY13 On	50	
JEEP		
CHEROKEE		
XJ Limited, Sport	52	
WG, WJ - 6/99-05	53	
GRAND CHEROKEE		
WRANGLER		
TJ	54	
JK	55	

Fitting sheet (located page 208) must be completed when suspension fitted. Failure to comply may affect warranty.

TABLE OF CONTENTS

Version 7 - Q1 2020

Unless specified otherwise, all listings in this catalogue are for 4WD (Four Wheel Drive) vehicles only.

JL.....	56	NM, NP, NS, NT, NW, NX (LWB).....	84
COMING SOON IN 2020!.....	57	NM, NP, NS, NT, NW, NX (SWB).....	86
GLADIATOR.....	57	PAJERO SPORT	
LAND ROVER		QE.....	88
80, 88 SWB, 109 LWB		TRITON	
SERIES I, II, IIA & III.....	58	ME, MF, MG, MH, MK.....	90
110 COUNTY ONLY.....	59	ML MN (To MY15).....	92
DEFENDER		MQ.....	94
90, 110, 130 Series.....	60	MR.....	96
DISCOVERY		NISSAN	
SERIES I.....	62	NAVARA	
SERIES III (4/05-2009).....	64	D21, D22.....	98
RANGE ROVER 'CLASSIC'		D40 - 2.5L, 4.0L.....	100
NON AIR SUSPENSION.....	65	D40 - 3.0L STX-550 V6.....	102
WITH AIR SUSPENSION.....	66	NP300 - Coil Rear Only.....	104
LADA		NP300 - Leaf rear only.....	106
NIVA		PATHFINDER	
ALL.....	67	WNYD21, WHYD21.....	108
LDV		R50 (Series I, II, III).....	109
T60		R51 - 2.5L, 4.0L.....	110
ALL.....	68	R51 - 3.0L V6.....	112
MAZDA		PATROL	
B2500, B2600, B4000		9/80-88 MQ, MK.....	114
PC, PD, PE, PG, PH.....	70	GQ Patrol (Y60) - 2" Lift.....	116
BT-50		GU Patrol (Y61) - 2" Lift.....	118
B2500, B3000.....	71	GQ, GU Patrol (Y60, Y61) - 3" Lift.....	120
UP, UR.....	72	GQ, GU Patrol (Y60, Y61) - 4" Lift.....	122
MERCEDES-BENZ		GQ, GU Patrol (Y60, Y61) - 5" Lift.....	124
X-CLASS UTE		GQ, GU Patrol (Y60, Y61) - 6" Lift.....	126
X22D/X250D/X350D.....	74	GQ Cab Chassis (Leaf/Leaf).....	128
MITSUBISHI		GQ, GU Cab Chassis (Coil/Leaf).....	130
CHALLENGER		GQ, GU Cab Chassis (Coil/Coil).....	132
PA - LEAF REAR.....	76	Y62 (Non Hydraulic Suspension Only).....	134
PA II - COIL REAR.....	77	TERRANO II	
PB & PC.....	78	R20.....	136
L200 4WD		SSANGYONG	
MA, MB, MC, MD.....	80	MUSSO (INC SPORT UTE)	
L300 4WD		ALSO SEE DAEWOO.....	137
SC, SD, SE, SF, SG, SH.....	81	SUZUKI	
PAJERO / MONTERO		JIMNY	
LEAF REAR.....	82	SN413 (JB33/43/48).....	138
COIL REAR.....	83	JB74.....	140

All prices exclude freight. Include only permanent accessories & weights when selecting springs. Towing weight is not included

TABLE OF CONTENTS

Version 7 - Q1 2020

Unless specified otherwise, all listings in this catalogue are for 4WD (Four Wheel Drive) vehicles only.

SIERRA		FJ CRUISER	
LEAF SPRING ONLY.....	142	All Models.....	200
VITARA		RAV 4	
INCLUDES GRAND VITARA & XL-7.....	143	SXA 10, 11.....	202
TOYOTA		TUNDRA	
FORTUNER		UCK, UPK, USK 55, 56.....	203
04 - 12/15.....	144	UAZ	
15 On.....	146	ALL MODELS	
GUN156.....	146	UAZ, HUNTER, PATRIOT.....	204
4RUNNER		VOLKSWAGEN	
IFS WITH LEAF REAR.....	148	AMAROK	
IFS WITH COIL REAR.....	149	All Models.....	205
HILUX		FITTING SHEET	
LEAF/LEAF 4WD.....	150	PLEASE COMPLETE THIS FORM BEFORE ANY	
TORSION BAR FRONT.....	152	FITMENT.....	206
TORSION BAR FRONT.....	154	CLAIMS FORM	
KUN26R GGN25R (COIL/LEAF).....	156	WARRANTY & RETURNS	
GUN125R, 126R GGN125R (COIL/LEAF).....	158	DISCLAIMER FORM	
LANDCRUISER		VEHICLES LIFTED MORE THAN 50MM.....	208
40, 42 SERIES.....	160	VEHICLE WEIGHT	
45, 47 SERIES.....	162	GVM & RELATED INFORMATION.....	209
60, 61, 62 SERIES.....	164		
70 SERIES BUNDERA.....	166		
71, 74 SERIES SWB & LWB.....	167		
70, 73, 74 SERIES.....	168		
75 SERIES.....	170		
76 SERIES WAGON.....	172		
77 SERIES FZJ77, HZJ77, PZJ77.....	174		
78 SERIES WITH COIL SPRINGS.....	175		
78, 79 SERIES INC V8 (EXCEPT DUAL CAB).....	176		
78, 79 SERIES INC V8 (EXCEPT DUAL CAB).....	177		
79 SERIES DUAL CAB.....	178		
80 & 105 SERIES.....	180		
80 & 105 SERIES 3" LIFT.....	182		
80 & 105 SERIES 4" LIFT.....	184		
80 & 105 SERIES 5" LIFT.....	186		
80 & 105 SERIES 6" LIFT.....	188		
100 SERIES (IFS).....	190		
200 Series.....	192		
PRADO			
95 SERIES.....	194		
120 SERIES LWB & SWB.....	196		
150 SERIES LWB & SWB.....	198		

Fitting sheet (located page 208) must be completed when suspension fitted. Failure to comply may affect warranty.

LIMITED WARRANTY

TERMS & CONDITIONS

This warranty is provided by 4 Way Suspension Products Pty Ltd, of 14 Darling Street Marsden Park, NSW, 2765, Australia through its dealers and agents in the relevant territory.

Please note: All Warranty Claims are to be returned to the place of original purchase

Our goods come with guarantees that cannot be excluded under the Australian Consumer Law. You are entitled to a replacement or refund for a major failure and compensation for any other reasonably foreseeable loss or damage. You are also entitled to have the goods repaired or replaced if the goods fail to be of acceptable quality and the failure does not amount to a major failure.

The benefits under our limited warranty are in addition to other rights and remedies under applicable law in relation to the product. At 4 Way Suspension Products Pty Ltd, we want you to have complete confidence in each and every 4 Way product you own. That's why we back our products with a manufacturer's warranty.

ACCOUNTS

Account applications that are approved must comply with the following Term & Conditions

1. All export orders must be prepaid before shipment.
2. Credit terms are 30 days from the end of the trading month.
3. Credit will be suspended if payment is not made within the trading terms.
4. Unpaid accounts at 30 days will be placed on stop supply.
5. If no credit arrangement exists, all goods must be prepaid before leaving 4 Way Suspension premises.
6. If the applicant is a company, the Director's Guarantee must be completed by all relevant parties.

FREIGHT & INSURANCE

All prices are quoted Ex-Warehouse and do not include freight. Ownership of the goods passes to the buyer at the time they leave the 4 Way Suspension Premises, providing that payment has been made according to the applicable account terms. Unless specified otherwise, freight will be added to the total cost of goods using the Supplier's preferred freight company.

CREDIT & WARRANTY RETURNS

Goods for credit or exchange must be returned within fourteen (14) days of invoice date accompanied by a completed **Returns Form**. Goods returned for the purpose of warranty claim must also be accompanied by the returns form along with a copy of the customer invoice. Freight for returned goods can be arranged by the returning party or by 4 Way Suspension, but in both cases, the associated costs remain the responsibility of the returning party.

15% OF THE TOTAL VALUE OF THE RETURNED GOODS WILL BE CHARGED IN THE EVENT THAT REPACKAGING IS REQUIRED

WARRANTY EXCLUSIONS

1. Parts that have been incorrectly installed.
2. Struts that have been assembled with the use of any tool other than hand tools (no rattle guns or impact tools)
3. Load bearing strut bushes that have been tightened while hanging. Strut bushes must be tightened while the vehicle is on the ground supporting its own weight.
4. Interference between shock absorber and other suspension components.
5. Parts that have been involved in a motor vehicle accident or have been bent or have been physically damaged by impact of any kind.
6. Parts showing evidence of improper tightening of the mounting bolts causing parts to wear or bend.
7. Gripping tool marks (vice grips or multi grips) or any other tool made marks on the polished chrome section of the shock

absorber shaft.

8. All parts subjected to abuse.
9. All parts used in racing or competition events of any description.
10. Any special order parts (in which case the warranty is limited to manufacturing defects)
11. Parts fitted to vehicles weighing more than original GVM or the revised GVM specified by a Tough Dog GVM upgrade.

Please Note: Any components built to a special order or specification outside the catalogue listings is covered by warranty limited to manufacturing defects. The manufacturer is unable to guarantee the suitability of components for an application for which has not been tested. Failure arising as a result of the application is excluded.

PROOF OF PURCHASE

A copy of proof of purchase by the retail customer must be attached to the claim including the kilometre reading at the time of fitment (if applicable). Each 4WD Suspension fitted must have a fitting sheet completed and kept on file by either the vehicle owner or the fitment centre performing the work. Failure to produce the fitting sheet may affect the warranty of the product.

WARRANTY PERIODS

53mm Ralph & 45mm Adjustable (std use)	3 Year/unlimited km
53mm Ralph & 45mm Adjustable (Commercial)	2 Year/unlimited km
35mm Nitro Gas Shocks	2 Year/unlimited km
Foam Cell & 40mm Adjustable	3 Year/unlimited km
RTC/EXT/SV Dampers	3 Year/unlimited km
Leaf Springs	3 Year/unlimited km
Coil Springs (up to 2")	3 year/unlimited km
Coil Springs (above 2")	2 year/unlimited km
Upper Control Arms	3 year/unlimited km
AirAssist Products	3 year/unlimited km
GVM Upgrades (Std Use)	3 year/unlimited km
GVM Upgrades (Commercial Use)	2 year/unlimited km
Recovery Equipment	3 years (material & manufacture)

SELF FIT (DIY) SUSPENSIONS

DIY suspension fitment does not affect the warranty application or term as long as the following conditions are adhered to:

1. A fitting sheet is completed prior to the suspension being fitted and filed for later reference.
2. The above fitment sheet accurately and clearly includes bottom of rim to wheel arch measurements for all four corners of the vehicle both before and after fitment, as well as at the 500km check service.
3. U-Bolts must be replaced at the time of fitment. U-Bolts are a 'stretch fit' item, and should not be torqued to tightness twice. Re-using U-Bolts puts the vehicle and occupants at risk.

WARRANTY LIMITS

4 Way Suspension Products Pty Ltd provides this product warranty which is limited to the repair or replacement of defective or faulty parts and does not include any costs incurred in labour for the removal or re-fitment of parts or damage incurred as a result of the product's fitment.

All prices exclude freight. Include only permanent accessories & weights when selecting springs. Towing weight is not included

P: (02) 9672 8899 | F: (02) 9672 8099



ROCK DOG

ROCK CRAWLING COMPETITION COILOVERS

SLOW SPEED COMPETITION USE ONLY

Coilover setup can be complex - Please call (02) 9672 8899 to tailor a solution

PART NO.	QTY	DESCRIPTION	RRP inc GST	NOTES
SHOCK ABSORBERS				
BMX45305	2	Shock - 12" Travel (505/810mm)		Includes Heim Joints
BMX45355	2	Shock - 14" Travel (565/910mm)		
BMX45406	2	Shock - 16" Travel (610/1015mm)		
COIL SPRINGS				
TDC-BMX160	2	160lbs Coil Spring		One Piece Design - Tender Built In
TDC-BMX180	2	180lbs Coil Spring		
TDC-BMX100	2	100lbs Tender Coil Spring		
TDC-BMX180T	2	180lbs Dual Rate (Tapered) Coil		
<i>Custom Coil Design Available - Contact us on (02) 9672 8899</i>				
COMPONENTS				
TDUK-2000	1	Urethane Spring Connector		Urethane seating Collar
TDUK-2001	1	Urethane Protector Sleeve		Protects shock body from spring
361321	1	QA1 Heim Joints		Replacement Unit



All prices exclude freight. Include only permanent accessories & weights when selecting springs. Towing weight is not included

P: (02) 9672 8899 | F: (02) 9672 8099



RECOVERY GEAR

RECOVERY EQUIPMENT

RECOVERY KITS & COMPONENTS

PART NO.	QTY	DESCRIPTION	RRP inc GST	NOTES
RECOVERY KITS				
TDRK-08T	1	8T Complete Recovery Kit		Includes 8 Tonne Snatch Strap
TDRK-11T	1	11T Complete Recovery Kit		Includes 11 Tonne Snatch Strap
INDIVIDUAL RECOVERY COMPONENTS				
TDRG-001	1	8 Tonne Snatch Strap		9 Metres 20% Stretch
TDRG-002	1	11T Snatch Strap		9 Metres 20% Stretch
TDRG-003	1	10T Tree Trunk Protector		3 Metres Double Stitched
TDRG-004	1	10T Winch Extension Strap		20 Metres
TDRG-005	1	10T Pulley Block		Greasable centre pin
TDRG-006	1	4.75T W.L.L Bow Shackle		Hot Dipped Galvanised Coating

PRODUCT DETAILS

PART NO.	LENGTH	M.B.S	COLOUR	NOTES
RECOVERY COMPONENT SPECIFICATION				
TDRG-001	9 M	8,000 kg	Yellow	100% Nylon, 20% Stretch
TDRG-002	9 M	11,000 kg	Orange	100% Nylon, 20% Stretch
TDRG-003	3 M	10,000 kg	Purple	
TDRG-004	20 M	10,000 kg	Green	
TDRG-005		10,000 kg	Yellow	Greasable centre pin
TDRG-006		4.75T W.L.L	Yellow	Hot Dipped Galvanised Coating
Damper Blanket	Not for individual sale		Black	PVC Blanket with weight pockets
Gloves	Not for individual sale		Black	Synthetic outer leather palm with grip palm & finger pads
Storage Bag	Not for individual sale		Red/Black	1200 Denier Material, Self supporting main opening.

Fitting sheet (located page 208) must be completed when suspension fitted. Failure to comply may affect warranty.

RECOVERY GEAR

COMPLETE KIT INCLUDES



1	8T Snatch Strap
	OR
1	11T Snatch Strap
1	10T Winch Extension Strap
1	10T Tree Trunk Protector
1	10T Pulley Block
2	4.75T W.L.L Bow Shackles
1	Pair Gloves
1	Recovery Damper Blanket
1	Heavy Duty Recovery Bag



8T & 11T Snatch Strap



10T Winch Extension Strap



10T Tree Trunk Protector



Heavy Duty 1200 Denier Recovery Bag



4.75T Bow Shackles

10T Pulley Block



Heavy Duty Gloves



ASIA MOTORS

ROCSTA
7/93-00
AM102



FRONT SUSPENSION

ESTIMATED LIFT: 50mm

PART NO.	QTY	DESCRIPTION	RRP inc GST	NOTES
SHOCK ABSORBERS				
BD1102T	2	35mm Nitrogen Gas Shock		Suits OE Height Only
BM401102	2	40mm 9 Stage Adjustable Shock		
BD1104T	2	35mm Nitrogen Gas		Suits 50mm Lift
BM401104	2	40mm 9 Stage Adjustable		
STEERING DAMPER				
SD5700	1	Steering Damper		
COMPONENTS				
TDUK-001	1	Urethane Shackle Bushing Kit		
TDUB-001	2	U-Bolt Kit		

REAR SUSPENSION

SHOCK ABSORBERS				
BD1364T	2	35mm Nitrogen Gas Shock		Suit OE Height
BM401364	2	40mm 9 Stage Adjustable Shock		
BD1366T	2	35mm Nitrogen Gas		Suit 50mm Lift
BM401366	2	40mm 9 Stage Adjustable		
COMPONENTS				
TDUK-001	1	Urethane Shackle Bushing Kit		
TDUB-001	2	U-Bolt Kit		

REPLACEMENT BUSHINGS

QUANTITY PER SHOCK				
TW959	2	Front Top Pin Mount		Pin Style Bushing
404702	1	Bottom Front Eying		Eying Bushing
404702	2	Top & Bottom Rear Eying		Eying Bushing

Fitting sheet (located page 208) must be completed when suspension fitted. Failure to comply may affect warranty.



DAEWOO

MUSSO

7/98-02

FRONT SUSPENSION

ESTIMATED LIFT: 35mm

PART NO.	QTY	DESCRIPTION	RRP inc GST	NOTES
SHOCK ABSORBERS				
BD2057T	2	35mm Nitrogen Gas Shock		Suits up to 35mm Lift
TORSION BARS				
4WTB-1800	1	Replacement Torsion Bars (Pair)		26mm/1040mm
Adjust Torsion bars after fitting shocks - Ensure a minimum of 60mm droop is maintained				

REAR SUSPENSION

SHOCK ABSORBERS				
BD1104T	2	35mm Nitrogen Gas Shock		Suit OE Height
BM401104	2	40mm 9 Stage Adjustable Shock		
BD1105T	2	35mm Nitrogen Gas		Suit 35mm Lift
BM401105	2	40mm 9 Stage Adjustable		
COIL SPRINGS				
TDC100	2	0-300KG Load		35mm Lift
TDC100H	2	CONSTANT 300Kg Load		35mm Lift

REPLACEMENT BUSHINGS

QUANTITY PER SHOCK				
TW959	2	Front Top Pin Mount		Pin Style Bushing
412772	1	Bottom Front Eying		Eying Bushing
TW959	2	Rear Top Pin Mount		Pin Style Bushing
404702	1	Bottom Rear Eying		Eying Bushing

COMPLETE KIT PRICE REFERENCE

SHOCK CHOICE	SPRING CHOICE	RRP inc GST	CONTENTS
35mm Nitrogen Gas	ANY		
40mm 9 Stage Adjustable	ANY		
Includes 4 x Shocks 2 x Coil Springs			

All prices exclude freight. Include only permanent accessories & weights when selecting springs. Towing weight is not included

DAIHATSU

F10 F20, F50, F60

8/75-84

INCLUDING SCAT



FRONT SUSPENSION

ESTIMATED LIFT: No Springs Avail.

PART NO.	QTY	DESCRIPTION	RRP inc GST	NOTES
SHOCK ABSORBERS				
BD1364T	2	35mm Nitrogen Gas Shock		Suits OE Height Only
BM401364	2	40mm 9 Stage Adjustable Shock		
BD1366T	2	35mm Nitrogen Gas		Suits 50mm Lift
BM401366	2	40mm 9 Stage Adjustable		
COMPONENTS				
TDUK-019	1	Urethane Shackle Bushing Kit		All Excluding F50
TDUK-020	1	Urethane Shackle Bushing Kit		Suits F50 Only
TDUB-027	2	U-Bolt Kit		

REAR SUSPENSION

SHOCK ABSORBERS				
BD1366T	2	35mm Nitrogen Gas Shock		Suit OE Height
BM401366	2	40mm 9 Stage Adjustable Shock		
BD1382T	2	35mm Nitrogen Gas		Suit 50mm Lift
BM401382	2	40mm 9 Stage Adjustable		
COMPONENTS				
TDUK-019	1	Urethane Shackle Bushing Kit		All Excluding F50
TDUK-020	1	Urethane Shackle Bushing Kit		Suits F50 Only
TDUB-027	2	U-Bolt Kit		

REPLACEMENT BUSHINGS

QUANTITY PER SHOCK				
404702	2	Suits Top & Bottom Front & Rear		Eyering Bushing

Fitting sheet (located page 208) must be completed when suspension fitted. Failure to comply may affect warranty.



DAIHATSU

F25, F55, F65
2/80-84

FRONT SUSPENSION

ESTIMATED LIFT: No Springs Avail.

PART NO.	QTY	DESCRIPTION	RRP inc GST	NOTES
SHOCK ABSORBERS				
BD1366T	2	35mm Nitrogen Gas Shock		Suits OE Height Only
BM401366	2	40mm 9 Stage Adjustable Shock		
BD1382T	2	35mm Nitrogen Gas		Suits 50mm Lift
BM401382	2	40mm 9 Stage Adjustable		
COMPONENTS				
TDUK-002	1	Urethane Shackle Bushing Kit		
TDUB-027	2	U-Bolt Kit		

REAR SUSPENSION

SHOCK ABSORBERS				
BD1400T	2	35mm Nitrogen Gas Shock		Suit OE Height
BM401400	2	40mm 9 Stage Adjustable Shock		
BD1441T	2	35mm Nitrogen Gas		Suit 50mm Lift
BM401441	2	40mm 9 Stage Adjustable		
COMPONENTS				
TDUK-023	1	Urethane Shackle Bushing Kit		
TDUB-027	2	U-Bolt Kit		

REPLACEMENT BUSHINGS

QUANTITY PER SHOCK				
404702	2	Suits Top & Bottom Front Shock		Eyering Bushing
404702	1	Suits Top Eyering Mount Rear		Eyering Bushing
TW959	2	Suits Bottom Pin Mount Rear		Pin Style Bushing

All prices exclude freight. Include only permanent accessories & weights when selecting springs. Towing weight is not included

P: (02) 9672 8899 | F: (02) 9672 8099



DAIHATSU

FEROZA

10/88-98

CX12, F300



FRONT SUSPENSION

ESTIMATED LIFT: 40mm

PART NO.	QTY	DESCRIPTION	RRP inc GST	NOTES
SHOCK ABSORBERS				
BD2057T	2	35mm Nitrogen Gas Shock		All Applications
TORSION BARS				
4WTB-0197	1	Replacement Torsion Bars (Pair)		26mm/1093mm
Adjust Torsion bars after fitting shocks - Ensure a minimum of 60mm droop is maintained				

REAR SUSPENSION

SHOCK ABSORBERS				
BD1102T	2	35mm Nitrogen Gas Shock		Suit OE Height
BM401102	2	40mm 9 Stage Adjustable Shock		
BD1104T	2	35mm Nitrogen Gas		Suit 40mm Lift
BM401104	2	40mm 9 Stage Adjustable		
LEAF SPRINGS				
T67	2	0-300Kg Load		40mm Lift
COMPONENTS				
TDUK-003	1	Urethane Shackle Bushing Kit		
TDUB-027	2	U-Bolt Kit		

REPLACEMENT BUSHINGS

QUANTITY PER SHOCK				
TW959	2	Suits Top Front Pin Bushing		Pin Style Bushing
412772	1	Suits Bottom Front Eye Bushing		Eyering Bushing
TW959	2	Suits Top Rear Pin Bushing		Pin Style Bushing
404702	1	Suits Bottom Rear Eye Bushing		Eyering Bushing

COMPLETE KIT PRICE REFERENCE

SHOCK CHOICE	SPRING CHOICE	RRP inc GST	CONTENTS
35mm Nitrogen Gas	0-300KG		
40mm 9 Stage Adjustable	0-300KG		
Includes 2 x Leaf Springs 4 x Shocks 1x Urethane Kits 2x U-Bolt Kits			

Fitting sheet (located page 208) must be completed when suspension fitted. Failure to comply may affect warranty.



DAIHATSU

FEROZA II

4/92-98
F310

FRONT SUSPENSION

ESTIMATED LIFT: 40mm

PART NO.	QTY	DESCRIPTION	RRP inc GST	NOTES
SHOCK ABSORBERS				
BD2057T	2	35mm Nitrogen Gas Shock		All Applications
TORSION BARS				
4WTB-0197	1	Replacement Torsion Bars (Pair)		26mm/1093mm
Adjust Torsion bars after fitting shocks - Ensure a minimum of 60mm droop is maintained				

REAR SUSPENSION

SHOCK ABSORBERS				
BD1005T	2	35mm Nitrogen Gas Shock		Suit OE Height
BM401005	2	40mm 9 Stage Adjustable Shock		
BD1007T	2	35mm Nitrogen Gas		Suit 40mm Lift
BM401007	2	40mm 9 Stage Adjustable		
LEAF SPRINGS				
T76	2	0-300Kg Load		40mm Lift
COMPONENTS				
TDUK-022	1	Urethane Shackle Bushing Kit		
TDUB-027	2	U-Bolt Kit		

REPLACEMENT BUSHINGS

QUANTITY PER SHOCK				
TW959	2	Suits Top Front Pin Bushing		Pin Style Bushing
412772	1	Suits Bottom Front Eye Bushing		Eyering Bushing
TW959	2	Suits Top Rear Pin		Pin Style Bushing
404702	2	Suits Bottom Rear Eyering		Eyering Bushing

COMPLETE KIT PRICE REFERENCE

SHOCK CHOICE	SPRING CHOICE	RRP inc GST	CONTENTS
35mm Nitrogen Gas	0-300KG		
40mm 9 Stage Adjustable	0-300KG		
Includes 4 x Leaf Springs 4 x Shocks 2x Urethane Kits 4x U-Bolt Kits			

All prices exclude freight. Include only permanent accessories & weights when selecting springs. Towing weight is not included

P: (02) 9672 8899 | F: (02) 9672 8099



DAIHATSU

ROCKY

6/84-93 - F70, F75

6/84-89 - F80, F85



FRONT SUSPENSION

ESTIMATED LIFT: 40mm

PART NO.	QTY	DESCRIPTION	RRP inc GST	NOTES
SHOCK ABSORBERS				
BD1102TB	2	35mm Nitrogen Gas Shock		Suit OE Height
BM401102	2	40mm 9 Stage Adjustable Shock		
BD1104TB	2	35mm Nitrogen Gas		Suit 40mm Lift
BM401104	2	40mm 9 Stage Adjustable		
LEAF SPRINGS				
T65	2	Petrol/Diesel/Bar		Suits LWB Only
T65C	2	Petrol/Diesel/Bar		Suits SWB Only
COMPONENTS				
TDUK-002	1	Urethane Shackle Bushing Kit		
TDUB-002	1	U-Bolt Kit		Suits D/S (1 Kit Req'd)
TDUB-027	1	U-Bolt Kit		Suits P/S (1 Kit Req'd)

REAR SUSPENSION

SHOCK ABSORBERS				
BD1400T	2	35mm Nitrogen Gas Shock		Suit OE Height
BM401400	2	40mm 9 Stage Adjustable Shock		
BD1104T	2	35mm Nitrogen Gas		Suit 40mm Lift
BM401104	2	40mm 9 Stage Adjustable		
LEAF SPRINGS				
T64	2	0-300Kg Load		Suits LWB Only
T64M	2	0-300Kg Load		Suits SWB Only
COMPONENTS				
TDUK-003	1	Urethane Shackle Bushing Kit		
TDUB-027	2	U-Bolt Kit		

REPLACEMENT BUSHINGS

QUANTITY PER SHOCK				
TW959	2	Suits Top Pin - Front & Rear		Pin Style Bushing
404702	2	Suits Bottom Eye - Front & Rear		Eyering Bushing

COMPLETE KIT PRICE REFERENCE

SHOCK CHOICE	SPRING CHOICE	RRP inc GST	CONTENTS
35mm Nitrogen Gas	0-300KG SWB		
40mm 9 Stage Adjustable	0-300KG SWB		
Includes 4 x Leaf Springs 4 x Shocks 2x Urethane Kits 4x U-Bolt Kits			

Fitting sheet (located page 208) must be completed when suspension fitted. Failure to comply may affect warranty.



DAIHATSU

ROCKY

11/86-93

F77, F87 PICKUP & TRAYBACK

FRONT SUSPENSION

ESTIMATED LIFT: No Springs Avail.

PART NO.	QTY	DESCRIPTION	RRP inc GST	NOTES
SHOCK ABSORBERS				
BD1102TB	2	35mm Nitrogen Gas Shock		Suit OE Height
BM401102	2	40mm 9 Stage Adjustable Shock		
BD1104TB	2	35mm Nitrogen Gas		Suit 40mm Lift
BM401104	2	40mm 9 Stage Adjustable		
COMPONENTS				
TDUK-002	1	Urethane Shackle Bushing Kit		
TDUB-002	2	U-Bolt Kit		

REAR SUSPENSION

SHOCK ABSORBERS				
BD1400T	2	35mm Nitrogen Gas Shock		Suit OE Height
BM401400	2	40mm 9 Stage Adjustable Shock		
BD1441T	2	35mm Nitrogen Gas		Suit 40mm Lift
BM401441	2	40mm 9 Stage Adjustable		
COMPONENTS				
TDUB-027	2	U-Bolt Kit		

REPLACEMENT BUSHINGS

QUANTITY PER SHOCK				
TW959	2	Suits Pin - Front & Rear		Pin Style Bushing
404702	1	Suits Eye - Front & Rear		Eyering Bushing

All prices exclude freight. Include only permanent accessories & weights when selecting springs. Towing weight is not included

DAIHATSU

ROCKY

8/93-99

F73, F78 (COIL SPRINGS)



FRONT SUSPENSION

ESTIMATED LIFT: 40mm

PART NO.	QTY	DESCRIPTION	RRP inc GST	NOTES
SHOCK ABSORBERS				
FC42019B	2	41mm Foam Cell Shock		
TORSION BARS				
4WTB-0198	1	Replacement Torsion Bars		26mm/1093mm
Adjust Torsion bars after fitting shocks - Ensure a minimum of 60mm Droop is Maintained				

REAR SUSPENSION

SHOCK ABSORBERS				
FC41184	2	41mm Foam Cell Shock		
BM401184	2	40mm 9 Stage Adjustable		
COIL SPRINGS				
TDC066	2	0-300Kg Load		40mm Lift

REPLACEMENT BUSHINGS

QUANTITY PER SHOCK				
TW959	2	Suits Top Front Pin		Pin Style Bushing
412772	1	Suits Bottom Front Eye		Eyering Bushing
TW959	2	Suits Top Rear Pin		Pin Style Bushing

COMPLETE KIT PRICE REFERENCE

SHOCK CHOICE	SPRING CHOICE	RRP inc GST	CONTENTS
41mm Foam Cell	0-300KG		
Foam Cell Front	0-300KG		
Adjustable Rear			
Includes 4 x Shock Absorbers 2 x Coil Springs			

Fitting sheet (located page 208) must be completed when suspension fitted. Failure to comply may affect warranty.

DODGE

RAM

COMING SOON!!
1500 SERIES

FRONT SUSPENSION

ESTIMATED LIFT: 50mm

PART NO.	QTY	DESCRIPTION	RRP inc GST	NOTES
SHOCK ABSORBERS				
FC404927	2	40mm Foam Cell Strut		
BM404927	2	40mm Adjustable Strut		9 Stage Adjustable
COIL SPRINGS				
TDC1024	2	40mm Lift Spring		Suits no Accessories
TDC1025	2	40mm Lift Spring		Suits up to Bar & Winch
COMPLETE STRUT ASSEMBLY				
DOD-001	2	BM404927/TDC1024		Petrol/Diesel With Bar
DOD-002	2	BM404927/TDC1025		Petrol/Diesel with Bar & Winch
DOD-003	2	FC404927/TDC1024		Petrol/Diesel With Bar
DOD-004	2	FC404927/TDC1025		Petrol/Diesel with Bar & Winch
ADDITIONAL COMPONENTS				
DOD-4927	2	Strut Top		Replacement Strut Top

REAR SUSPENSION

SHOCK ABSORBERS				
FC43033	2	41mm Foam Cell Shock		Up to 50mm Lift
BM403033	2	40mm 9 Stage Adjustable		Up to 50mm Lift
COIL SPRINGS				
TDC1026	2	0-300kg Load		50mm Lift
TDC1027	2	CONSTANT 300Kg Load		50mm Lift
TDC1028	2	CONSTANT 500Kg Load		50mm Lift

COMPLETE KIT PRICE REFERENCE

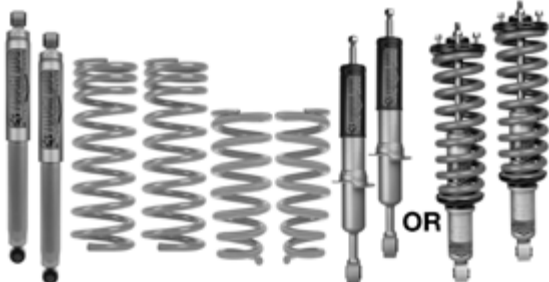
SHOCK CHOICE	SPRING CHOICE	RRP inc GST	CONTENTS
Foam Cell Struts Req. Assy	ANY		<p>Includes 2 x Front Struts 2 Front Coils (assembled or separate) 2 x Rear Shocks 2 x Rear Coils</p> 
Foam Cell Complete Assembly	ANY		
40mm Adjustable Struts Req Assy	ANY		
40mm Adjustable Complete Assembly	ANY		

All prices exclude freight. Include only permanent accessories & weights when selecting springs. Towing weight is not included

P: (02) 9672 8899 | F: (02) 9672 8099



FORD

EVEREST

2015 - 08/2018
UA1 Models



FRONT SUSPENSION

ESTIMATED LIFT: 40mm

PART NO.	QTY	DESCRIPTION	RRP inc GST	NOTES
SHOCK ABSORBERS				
FC404500	2	40mm Foam Cell Strut		
BM404500	2	40mm Adjustable Strut		9 Stage Adjustable
COIL SPRINGS				
TDC452	2	40mm Lift Spring		Petrol/Diesel/Bar
TDC452HL	2	40mm Lift Spring		Petrol/Diesel/Bar/Winch
COMPLETE STRUT ASSEMBLY				
MAZ-005	2	BM404500/TDC452		Petrol/Diesel/Bar
MAZ-006	2	BM404500/TDC452HL		Petrol/Diesel/Bar/Winch
MAZ-007	2	FC404500/TDC452		Petrol/Diesel/Bar
MAZ-008	2	FC404500/TDC452HL		Petrol/Diesel/Bar/Winch
ADDITIONAL COMPONENTS				
MAZ-4051	2	Strut Top		Replacement Strut Top
TDCA-003	1	Upper Control Arms (pair)		Suits up to 75mm lift

REAR SUSPENSION

SHOCK ABSORBERS				
FC43013	2	41mm Foam Cell Shock		Suits Up to 40mm Lift
BM403013	2	40mm 9 Stage Adjustable		Suits Up to 40mm Lift
COIL SPRINGS				
TDC453	2	0-300kg Load		40mm Lift
TDC453L	2	CONSTANT 300Kg Load		40mm Lift
AIR ASSIST BAGS				
TDAA-004	1	Coil insert bag kit		Suits 40mm Lift
TDAA-014	1	Coil insert bag kit		Suits standard height ONLY
REPLACEMENT BUSHINGS (QUANTITY PER SHOCK)				
MAZ-4051	1	Replacement Strut Top		Available As Complete Unit Only
ADJ00305	1	Suits Bottom Front Eye		Eyering Bonded Bushing

COMPLETE KIT PRICE REFERENCE

SHOCK CHOICE	SPRING CHOICE	RRP inc GST	CONTENTS
Foam Cell Struts Req. Assy	ANY		<p>Includes 2 x Front Struts 2 Front Coils (assembled or separate) 2 x Rear Shocks 2 x Rear Coils</p>
Foam Cell Complete Assembly	ANY		
40mm Adjustable Struts Req Assy	ANY		
40mm Adjustable Complete Assembly	ANY		

Fitting sheet (located page 208) must be completed when suspension fitted. Failure to comply may affect warranty.

FRONT SUSPENSION

ESTIMATED LIFT: 40mm

PART NO.	QTY	DESCRIPTION	RRP inc GST	NOTES
SHOCK ABSORBERS				
FC404520	2	40mm Foam Cell Strut		
BM404520	2	40mm Adjustable Strut		9 Stage Adjustable
COIL SPRINGS				
TDC1006	2	40mm Lift Spring		Diesel no accessories
TDC1007	2	40mm Lift Spring		Diesel with Bar or Bar+Winch
COMPLETE STRUT ASSEMBLY				
FOR-005	2	BM404520/TDC1006		Diesel no accessories
FOR-006	2	BM404520/TDC1007		Diesel with Bar or Bar+Winch
FOR-007	2	FC404520/TDC1006		Diesel no accessories
FOR-008	2	FC404520/TDC1007		Diesel with Bar or Bar+Winch
ADDITIONAL COMPONENTS				
FOR-4520	2	Strut Top		Replacement Strut Top
TDCA-003	1	Upper Control Arms (pair)		Suits up to 75mm lift

REAR SUSPENSION

SHOCK ABSORBERS				
FC43013	2	41mm Foam Cell Shock		Suits Up to 40mm Lift
BM403013	2	40mm 9 Stage Adjustable		Suits Up to 40mm Lift
COIL SPRINGS				
TDC453	2	0-300kg Load		40mm Lift
TDC453L	2	CONSTANT 300Kg Load		40mm Lift
AIR ASSIST BAGS				
TDAA-004	1	Coil insert bag kit		Suits 40mm Lift
TDAA-014	1	Coil insert bag kit		Suits standard height ONLY
QUANTITY PER SHOCK				
FOR-4520	1	Replacement Strut Top		Available As Complete Unit Only
ADJ00306	1	Suits Bottom Front Eye		Eyering Bonded Bushing

COMPLETE KIT PRICE REFERENCE

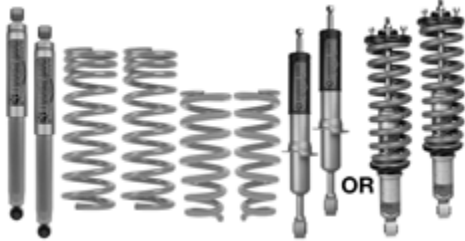
SHOCK CHOICE	SPRING CHOICE	RRP inc GST	CONTENTS
Foam Cell Struts Req. Assy	ANY		<p>Includes 2 x Front Struts 2 Front Coils (assembled or separate) 2 x Rear Shocks 2 x Rear Coils</p> 
Foam Cell Complete Assembly	ANY		
40mm Adjustable Struts Req Assy	ANY		
40mm Adjustable Complete Assembly	ANY		

All prices exclude freight. Include only permanent accessories & weights when selecting springs. Towing weight is not included

FORD

EXPLORER

10/96-05
UN, UP, UQ



FRONT SUSPENSION

No Springs Avail.

PART NO.	QTY	DESCRIPTION	RRP inc GST	NOTES
SHOCK ABSORBERS				
FC41450B	2	41mm Foam Cell Shock		Suits up to 40mm Lift

REAR SUSPENSION

SHOCK ABSORBERS				
FC41446	2	41mm Foam Cell Shock		Suits Up to 40mm Lift

COMPLETE KIT PRICE REFERENCE

SHOCK CHOICE	SPRING CHOICE	RRP inc GST	CONTENTS
41mm Foam Cell	0-300KG		Please Note: 1) The "Limited" comes standard with (Self Levelling) air shocks. These can be retained or removed as desired. If the (Self Levelling) air shocks are removed, the self
Includes 4 x Shocks			

levelling indicator light in the dash will turn on and off intermittently. The air hoses should be sealed off and fastened to the chassis for later use if needed.

2) The air compressor must be turned off. The switch is located in the left hand rear inspection console. If further electrical work is required, please consult an Automotive Electrician.

FORD

BRONCO

3/81-89
Third Generation



FRONT SUSPENSION

ESTIMATED LIFT: 40mm

PART NO.	QTY	DESCRIPTION	RRP inc GST	NOTES
SHOCK ABSORBERS (ALL EXCL. QUAD SHOCK)				
FC41130B	2	41mm Foam Cell Shock		Suits up to 30mm Lift
SHOCK ABSORBERS (QUAD SHOCK)				
FC41102B	2	41mm Foam Cell Shock		OE Height - Front of Axle
FC41130B	2	41mm Foam Cell Shock		OE Height - Rear of Axle

REAR SUSPENSION

SHOCK ABSORBERS (ALL MODELS)				
FC41379	2	41mm Foam Cell Shock		Suits Up to 30mm Lift

REPLACEMENT BUSHINGS

QUANTITY PER SHOCK				
TW959	2	Suits Top Front Pin		Pin Style Bushing (#1102B ONLY)
404702	1	Suits Bottom Front Eye		Eyering Bushing (#1102B ONLY)
404702	1	Suits Top Rear		Eyering Bushing
SPF420	1	Suits Bottom Rear		Eyering Bushing

Fitting sheet (located page 208) must be completed when suspension fitted. Failure to comply may affect warranty.



FORD

F250
03-06

Live Axle Front, Quad Rear Shocks

FRONT SUSPENSION

ESTIMATED LIFT: 100 mm

PART NO.	QTY	DESCRIPTION	RRP inc GST	NOTES
SHOCK ABSORBERS				
TDR3500	2	53mm 'Ralph' Big Bore		Suits OE Height Only
BMX3500/4	2	45mm 9 Stage Adjustable		Suits 100mm Lift
LEAF SPRINGS				
FS026	2	Petrol/Diesel/Alloy Bar		100mm Lift
FS026H	2	Petrol/Diesel/Bar/Winch		100mm Lift
STEERING DAMPER				
SS5250-XHD	1	XHD Return To Centre Damper		When fitted to OE height vehicle, Low ground clearance occurs
SV5250	1	'SV' 9 Stage Adjustable Damper		
COMPONENTS				
TDUK-064	1	Shackle Bushing Kit		Kit fitted to springs when ordered
TDUB-033	2	U-Bolt Kit		
TDPR-250	1	Adjustable Panhard Rod		

REAR SUSPENSION

SHOCK ABSORBERS				
BMX3501	2	45mm 9 Stage Adjustable		Forward of Rear Axle - OE Height
BMX3502	2	45mm 9 Stage Adjustable		Rear of Rear Axle - OE Height
BMX3501/4	2	45mm 9 Stage Adjustable		Forward of Rear Axle - 100mm lift
BMX3502/4	2	45mm 9 Stage Adjustable		Rear of Rear Axle - 100mm lift
LEAF SPRINGS				
FS027	2	0-500kg Load		100mm Lift
FS027H	2	CONSTANT 500Kg Load		100mm Lift
COMPONENTS				
TDUK-064	1	Shackle Bushing Kit		Kit fitted to springs when ordered
TDUB-034	2	U-Bolt Kit		

REPLACEMENT BUSHINGS

QUANTITY PER SHOCK				
TW038-16	1	Suits top mount all shocks		Eyering Bonded Bushing
TW038-12	1	Suits bottom mount all shocks		Eyering Bonded Bushing

COMPLETE KIT PRICE REFERENCE

SHOCK CHOICE	SPRING CHOICE	RRP inc GST	CONTENTS
45mm 9 Stage Adjustable	0-500KG Constant 500kg		
Includes 4 x Leaf Springs 6 x Shocks 2 x Bushing Kits 4 x U-Bolt Kits 1 x Panhard Rod			

All prices exclude freight. Include only permanent accessories & weights when selecting springs. Towing weight is not included

P: (02) 9672 8899 | F: (02) 9672 8099



FORD

COURIER

5/87-10/06

PC, PD, PE, PG, PH



FRONT SUSPENSION

ESTIMATED LIFT: 40mm

PART NO.	QTY	DESCRIPTION	RRP inc GST	NOTES
SHOCK ABSORBERS				
FC42051B	2	41mm Foam Cell Shock		Suits up to 40mm Lift
TDSK-020	1	Shock Mount Strengthening Kit		Top Pin Mount Bracket
Please Note: - Failure to fit TDSK-020 will cause top mount failure. Fitting instructions at toughdog.com.au				
TORSION BARS				
4WTB-1546	1	Replacement Torsion Bars		26mm/926mm
Adjust Torsion bars after fitting shocks - Ensure a minimum of 60mm Droop is Maintained				

REAR SUSPENSION

SHOCK ABSORBERS				
BD1232T	2	35mm Nitrogen Gas Shock		Suits Up to 40mm Lift
FC41232	2	41mm Foam Cell Shock		Suits Up to 40mm Lift
BM401232	2	40mm 9 Stage Adjustable		Suits Up to 40mm Lift
LEAF SPRINGS				
FS365	2	0-300kg Load		40mm Lift
FS367	2	CONSTANT 300Kg Load		40mm Lift
COMPONENTS				
TDUK-034	1	Urethane Shackle Bushing Kit		
TDUB-005	2	U-Bolt Kit		
REPLACEMENT BUSHINGS - QUANTITY PER SHOCK				
TW959 + TW961	1 (ea)	Suits Top Front Pin		Pin Style Bushing
4W-SPF420-05	1	Suits Bottom Front Eye		Suits Body # 42057 ONLY
4W-SPF420-02	1	Suits Bottom Front Eye		Suits Body # 42051 ONLY
ADJ00191	1	Suits Top Rear Eying		Suit Foam Cell Shocks
4W-SPF420-02	1	Suits Bottom Rear Eying		
230100	1	Suits Top Rear Eying		
230002	1	Suits Bottom Rear Eying		Suit 40mm Adjustable Shocks

COMPLETE KIT PRICE REFERENCE

SHOCK CHOICE	SPRING CHOICE	RRP inc GST	CONTENTS
Foam Cell Front Nitro gas Rear	0-300KG Constant 300kg		
41mm Foam Cell	0-300KG Constant 300kg		
Foam Cell Front Adjustable Rear	0-300KG Constant 300kg		
Includes 2 x Leaf Springs 4 x Shocks 1 x Urethane Kits 2 x U-Bolt Kits 1 x Shock Strengthening Kit			

Fitting sheet (located page 208) must be completed when suspension fitted. Failure to comply may affect warranty.



FORD RANGER 12/06-10/11 PJ & PK, 2.5L & 3.0L

FRONT SUSPENSION

ESTIMATED LIFT: 45 mm

PART NO.	QTY	DESCRIPTION	RRP inc GST	NOTES
SHOCK ABSORBERS				
FC42051B	2	41mm Foam Cell Shock		Suits up to 45mm Lift
TDSK-020	1	Shock Mount Strengthening Kit		Top Pin Mount Bracket
Please Note: - Failure to fit TDSK-020 will cause top mount failure. Fitting instructions at toughdog.com.au				
TORSION BARS - Adjust torsion bars after fitting shocks - ensure minimum droop of 60mm is maintained.				
4WTB-1440	1	Replacement Torsion Bars		27mm/1028mm

REAR SUSPENSION

SHOCK ABSORBERS				
BD1232T	2	35mm Nitrogen Gas Shock		Suits Up to 45mm Lift
FC41232	2	41mm Foam Cell Shock		Suits Up to 45mm Lift
BM401232	2	40mm 9 Stage Adjustable		Suits Up to 45mm Lift
LEAF SPRINGS				
FS368C	2	0-300kg Load		45mm Lift
FS368L	2	CONSTANT 300Kg Load		45mm Lift
COMPONENTS				
TDUK-069	1	Urethane Shackle Bushing Kit		
TDUB-040	2	U-Bolt Kit		Suits FS368C only
TDUB-039	2	U-Bolt Kit		Suits FS368L only
TDGS-386/1	1	Greasable Shackle Kit		
TDGP-668	1	Greasable Pin Kit		
AIR ASSIST BAGS				
TDAA-101	1	Bellows bag kit		Suits 45mm Lift
TDAA-117	1	Bellows bag kit		Suits standard height ONLY
REPLACEMENT BUSHES (QUANTITY PER SHOCK)				
TW959 (x1)+TW961 (x1)	1 + 1	Suits Top Front Pin (1 each req'd)		Pin Style Bushing
412772	1	Suits Bottom Front Eye		Eyering Bushing
ADJ00191	1	Suits Top Rear Eyering		Suit Foam Cell Shocks
4W-SPF420-02	1	Suits Bottom Rear Eyering		
230100	1	Suits Top Rear Eyering		Suit 40mm Adjustable Shocks
230002	1	Suits Bottom Rear Eyering		

COMPLETE KIT PRICE REFERENCE

SHOCK CHOICE	SPRING CHOICE	RRP inc GST	CONTENTS
Foam Cell Front Nitro gas Rear	0-300KG		<p>Includes 2 x Leaf Springs 4 x Shocks 1 x Urethane Kit 2 x U-Bolt Kits 1 x Shock Mount Kit</p>
41mm Foam Cell	0-300KG		
	Constant 300kg		
Foam Cell Front Adjustable Rear	0-300KG		
	Constant 300kg		

All prices exclude freight. Include only permanent accessories & weights when selecting springs. Towing weight is not included

P: (02) 9672 8899 | F: (02) 9672 8099



FORD

RANGER

11/2011 - 08/2018

PX & PX II- All Models



FRONT SUSPENSION

ESTIMATED LIFT: 40mm

PART NO.	QTY	DESCRIPTION	RRP inc GST	NOTES
SHOCK ABSORBERS				
FC404500	2	40mm Foam Cell Strut		
BM404500	2	40mm Adjustable Strut		9 Stage Adjustable
COIL SPRINGS				
TDC451	2	40mm Lift Spring		Petrol/Diesel/Bar
TDC451HL	2	40mm Lift Spring		Petrol/Diesel/Bar/Winch
COMPLETE STRUT ASSEMBLY				
MAZ-001	2	BM404500/TDC451		Petrol/Diesel/Bar
MAZ-002	2	BM404500/TDC451HL		Petrol/Diesel/Bar/Winch
MAZ-003	2	FC404500/TDC451		Petrol/Diesel/Bar
MAZ-004	2	FC404500/TDC451HL		Petrol/Diesel/Bar/Winch
ADDITIONAL COMPONENTS				
MAZ-4051	2	Strut Top		Replacement Strut Top
TDCA-003	1	Upper Control Arms (pair)		Suits up to 75mm lift

REAR SUSPENSION

SHOCK ABSORBERS				
BD1232T	2	35mm Nitrogen Gas Shock		Up to 40mm Lift (For Comfort)
FC41232	2	41mm Foam Cell Shock		Suits Up to 40mm Lift
BM401232	2	40mm 9 Stage Adjustable		Suits Up to 40mm Lift
LEAF SPRINGS				
FS369C	2	0-300kg Load		40mm Lift
FS369L	2	CONSTANT 300Kg Load		40mm Lift
FS369LL	2	CONSTANT 500Kg Load		40mm Lift
COMPONENTS				
TDUK-070	1	Urethane Shackle Bushing Kit		
TDUB-039	2	U-Bolt Kit		Suits FS369L & LL Spring
TDUB-040	2	U-Bolt Kit		Suits FS369C Spring Only
TDGS-390	1	Greasable Shackle Kit		
TDGP-668	1	Greasable Pin Kit		
TDSP-007	1	Transmission Spacer Kit		Must Be fitted to All Lift Kits
AIR ASSIST BAGS				
TDAA-102	1	Bellows bag kit		Suits 40mm Lift
TDAA-116	1	Bellows bag kit		Suits standard height ONLY
REPLACEMENT BUSHES (QUANTITY PER SHOCK)				
MAZ-4051	1	Replacement Strut Top		Available As Complete Unit Only
ADJ00305	1	Suits Bottom Front Eye		Eyering Bonded Bushing
ADJ00191	1	Suits Top Rear Eyering		Suit Foam Cell Shocks
4W-SPF420-02	1	Suits Bottom Rear Eyering		
230100	1	Suits Top Rear Eyering		Suit 40mm Adjustable Shocks
230002	1	Suits Bottom Rear Eyering		

Fitting sheet (located page 208) must be completed when suspension fitted. Failure to comply may affect warranty.

Note: Transmission spacer fitting instructions available at toughdog.com.au

FORD RANGER

11/2011 - 08/2018
PX & PXII - All Models

35mm Nitro Gas shocks should be used when extra comfort is desired in vehicles carrying little to no load. They are not suitable for heavy load carrying applications

SHOCK CHOICE	SPRING CHOICE	RRP inc GST	CONTENTS
<p>Foam Cell Struts Require Assembly</p> <p><u>Includes</u> 2x Front Struts 2x Rear Shocks 2x Front Coils 2x Leaf Springs 1x Urethane Kit 2x U-Bolt Kits 1x Transmission Spacer</p>	<p>FS369C (Foam Front Gas Rear)</p> <p>FS369C (Foam Cell All)</p> <p>FS369L CONSTANT 300KG</p> <p>FC369LL CONSTANT 500KG</p>		
<p>Foam Cell Complete Assembly Struts</p> <p><u>Includes</u> 2x Front Strut Assy 2x Rear Shocks 2x Leaf Springs 1x Urethane Kit 2x U-Bolt Kits 1x Transmission Space</p>	<p>FS369C (Foam Front Gas Rear)</p> <p>FS369C (Foam Cell All)</p> <p>FS369L CONSTANT 300KG</p> <p>FS369LL CONSTANT 500KG</p>		
<p>40mm Adjustable Struts Require Assembly</p> <p><u>Includes</u> 2x Front Struts 2x Rear Shocks 2x Front Coils 2x Leaf Springs 1x Urethane Kit 2x U-Bolt Kits 1x Transmission Spacer</p>	<p>FS369C 0-300KG</p> <p>FS369L CONSTANT 300KG</p> <p>FS369LL CONSTANT 500KG</p>		
<p>40mm Adjustable Complete Assembly Struts</p> <p><u>Includes</u> 2x Front Strut Assy 2x Rear Shocks 2x Leaf Springs 1x Urethane Kit 2x U-Bolt Kits 1x Transmission Spacer</p>	<p>FS369C 0-300KG</p> <p>FS369L CONSTANT 300KG</p> <p>FS369LL CONSTANT 500KG</p>		

All prices exclude freight. Include only permanent accessories & weights when selecting springs. Towing weight is not included

FORD

RANGER

08/2018 on
PXIII All Models



FRONT SUSPENSION

ESTIMATED LIFT: 40mm

PART NO.	QTY	DESCRIPTION	RRP inc GST	NOTES
SHOCK ABSORBERS				
FC404520	2	40mm Foam Cell Strut		
BM404520	2	40mm Adjustable Strut		9 Stage Adjustable
COIL SPRINGS				
TDC455	2	40mm Lift Spring		Petrol/Diesel/Bar
TDC455HL	2	40mm Lift Spring		Petrol/Diesel/Bar/Winch
COMPLETE STRUT ASSEMBLY				
FOR-001	2	BM404520/TDC455		Petrol/Diesel/Bar
FOR-002	2	BM404520/TDC455HL		Petrol/Diesel/Bar/Winch
FOR-003	2	FC404520/TDC455		Petrol/Diesel/Bar
FOR-004	2	FC404520/TDC455HL		Petrol/Diesel/Bar/Winch
ADDITIONAL COMPONENTS				
FOR-4520	2	Strut Top		Replacement Strut Top
TDCA-003	1	Upper Control Arms (pair)		Suits up to 75mm lift

REAR SUSPENSION





SHOCK ABSORBERS				
BD1232T	2	35mm Nitrogen Gas Shock		Up to 40mm Lift (For Comfort)
FC41232	2	41mm Foam Cell Shock		Suits Up to 40mm Lift
BM401232	2	40mm 9 Stage Adjustable		Suits Up to 40mm Lift
LEAF SPRINGS				
FS369C	2	0-300kg Load		40mm Lift
FS369L	2	CONSTANT 300Kg Load		40mm Lift
FS369LL	2	CONSTANT 500Kg Load		40mm Lift
COMPONENTS				
TDUK-070	1	Urethane Shackle Bushing Kit		
TDUB-039	2	U-Bolt Kit		Suits FS369L & LL Spring
TDUB-040	2	U-Bolt Kit		Suits FS369C Spring Only
TDGS-390	1	Greasable Shackle Kit		
TDGP-668	1	Greasable Pin Kit		
TDSP-007	1	Transmission Spacer Kit		Must Be fitted to All Lift Kits
AIR ASSIST BAGS				
TDAA-102	1	Bellows bag kit		Suits 40mm Lift
TDAA-116	1	Bellows bag kit		Suits standard height ONLY
QUANTITY PER SHOCK				
FOR-4520	1	Replacement Strut Top		Available As Complete Unit Only
ADJ00306	1	Suits Bottom Front Eye		Eyering Bonded Bushing
ADJ00191	1	Suits Top Rear Eyering		Suit Foam Cell Shocks
4W-SPF420-02	1	Suits Bottom Rear Eyering		
230100	1	Suits Top Rear BM401232		Suit 40mm Adjustable Shocks
230002	1	Suits Bottom Rear BM401232		

Fitting sheet (located page 208) must be completed when suspension fitted. Failure to comply may affect warranty.

FORD RANGER 08/2018 on PXIII - All Models

**Note: Transmission spacer
fitting instructions available
at toughdog.com.au**

*35mm Nitro Gas shocks should be used when extra comfort is desired in vehicles carrying little to no load.
They are not suitable for heavy load carrying applications*

SHOCK CHOICE	SPRING CHOICE	RRP inc GST	CONTENTS
<p>Foam Cell Struts Require Assembly Includes 2x Front Struts 2x Rear Shocks 2x Front Coils 2x Leaf Springs 1x Urethane Kit 2x U-Bolt Kits 1x Transmission Spacer</p>	<p>FS369C (Foam Front Gas Rear)</p> <p>FS369C (Foam Cell All)</p> <p>FS369L CONSTANT 300KG</p> <p>FC369LL CONSTANT 500KG</p>		
<p>Foam Cell Complete Assembly Struts Includes 2x Front Strut Assy 2x Rear Shocks 2x Leaf Springs 1x Urethane Kit 2x U-Bolt Kits 1x Transmission Space</p>	<p>FS369C (Foam Front Gas Rear)</p> <p>FS369C (Foam Cell All)</p> <p>FS369L CONSTANT 300KG</p> <p>FS369LL CONSTANT 500KG</p>		
<p>40mm Adjustable Struts Require Assembly Includes 2x Front Struts 2x Rear Shocks 2x Front Coils 2x Leaf Springs 1x Urethane Kit 2x U-Bolt Kits 1x Transmission Spacer</p>	<p>FS369C 0-300KG</p> <p>FS369L CONSTANT 300KG</p> <p>FS369LL CONSTANT 500KG</p>		
<p>40mm Adjustable Complete Assembly Struts Includes 2x Front Strut Assy 2x Rear Shocks 2x Leaf Springs 1x Urethane Kit 2x U-Bolt Kits 1x Transmission Spacer</p>	<p>FS369C 0-300KG</p> <p>FS369L CONSTANT 300KG</p> <p>FS369LL CONSTANT 500KG</p>		

All prices exclude freight. Include only permanent accessories & weights when selecting springs. Towing weight is not included

P: (02) 9672 8899 | F: (02) 9672 8099



FORD

RANGER RAPTOR

08/2018 on

PXIII RAPTOR MODELS ONLY



FRONT SUSPENSION

ESTIMATED LIFT: 40mm

PART NO.	QTY	DESCRIPTION	RRP inc GST	NOTES
COIL SPRINGS				
TDC1022	2	OE Height		With Bar & Winch ONLY

REAR SUSPENSION

COIL SPRINGS				
TDC1023	2	150-300kg Load		OE Height Only

Please Note:

The Ford Ranger Raptor features shock absorbers from Fox Suspension, which are an internal bypass style shock absorber, and are therefore height sensitive in their ride control. When additional accessories like front steel bars, or rear tub accessories are fitted, the ride height of the vehicle is altered, which in turn alters the performance of the shock absorber.

Tough Dog coils are designed to return the vehicle to the original ride height to maintain the ride quality, and should therefore only be fitted in the event that the appropriate level of accessory or other permanent load is present to ensure that the vehicle's ride is not adversely affected.

Fitting sheet (located page 208) must be completed when suspension fitted. Failure to comply may affect warranty.



GREAT WALL

UTE (WINGLE, SAILOR)

6/09 -16
V200, V240, 2.4L, 2.0L

ESTIMATED LIFT: 45 mm

SHOCK CHOICE	SPRING CHOICE	RRP inc GST	CONTENTS
SHOCK ABSORBERS			
FC42019B	2	41mm Foam Cell Shock	Suits up to 45mm Lift
TORSION BARS			
4WTB-1559	1	Replacement Torsion Bars	30mm/1145mm
Adjust Torsion bars after fitting shocks - Ensure a minimum of 60mm Droop is Maintained			

REAR SUSPENSION

SHOCK ABSORBERS			
BD1382T	2	35mm Nitrogen Gas Shock	Suits OE Height
FC41382	2	41mm Foam Cell Shock	
BM401382	2	40mm 9 Stage Adjustable	
BD1388T	2	35mm Nitrogen Gas Shock	Suits 45mm Lift
FC41388	2	41mm Foam Cell Shock	
BM401388	2	40mm 9 Stage Adjustable	
LEAF SPRINGS			
FS213	2	0-300kg Load	45mm Lift
FS213H	2	CONSTANT 300Kg Load	45mm Lift
COMPONENTS			
TDUK-065	1	Urethane Shackle Bushing Kit	
TDUB-039	2	U-Bolt Kit	
TDGS-386	1	Greasable Shackle Kit	
TDGP-668	1	Greasable Pin Kit	

REPLACEMENT BUSHINGS

QUANTITY PER SHOCK			
TW959	2	Suits Top Front Pin	Pin Style Bushing
412772	1	Suits Bottom Front Eying	Eying Bushing
404702	2	Suits Top & Bottom Rear Eying	Eying Bushing

COMPLETE KIT PRICE REFERENCE

SHOCK CHOICE	SPRING CHOICE	RRP inc GST	CONTENTS
Foam Cell Front Nitro gas Rear	0-300KG Constant 300kg		
41mm Foam Cell	0-300KG Constant 300kg		
Foam Cell Front Adjustable Rear	0-300KG Constant 300kg		
Includes			
2 x Leaf Springs 1 x Urethane Kits		4 x Shocks 2 x U-Bolt Kits	

All prices exclude freight. Include only permanent accessories & weights when selecting springs. Towing weight is not included

P: (02) 9672 8899 | F: (02) 9672 8099



GREAT WALL

4 DOOR (HOVER, SAFE, HAVAL)

09-16
X240, X200, 2.4L, 2.0L



FRONT SUSPENSION

ESTIMATED LIFT: 30 mm

PART NO.	QTY	DESCRIPTION	RRP inc GST	NOTES
SHOCK ABSORBERS				
FC42019B	2	41mm Foam Cell Shock		Suits up to 30mm Lift
TORSION BARS				
4WTB-1559	1	Replacement Torsion Bars		30mm/1145mm
Adjust Torsion bars after fitting shocks - Ensure a minimum of 60mm Droop is Maintained				

REAR SUSPENSION

SHOCK ABSORBERS				
FC41460	2	41mm Foam Cell Shock		Suits Up to 30mm Lift
BM401460	2	40mm 9 Stage Adjustable		Suits Up to 30mm Lift
COIL SPRINGS				
TDC045	2	0-300kg Load		30mm Lift

REPLACEMENT BUSHINGS

QUANTITY PER SHOCK				
TW959	2	Suits Top Front Pin		Pin Style Bushing
412772	1	Suits Bottom Front Eye		Eyering Bushing
TW959	2	Suits Top & Bottom Rear Pin		Pin Style Bushing
TW038/16	1	Suits Bottom Rear Eyering		Eyering Bushing

COMPLETE KIT PRICE REFERENCE

SHOCK CHOICE	SPRING CHOICE	RRP inc GST	CONTENTS
41mm Foam Cell	0-300KG		
Foam Cell Front Adjustable Rear	0-300KG		
Includes 2 x Coil Springs 4 x Shocks			

Fitting sheet (located page 208) must be completed when suspension fitted. Failure to comply may affect warranty.



HOLDEN

FRONTERA LWB & SWB

10/95-99 & 3/99-04
MB & MX 2 DOOR & 4 DOOR, 3.2L V6, 2.2L TDI

ESTIMATED LIFT: 40 mm

SHOCK CHOICE	SPRING CHOICE	RRP inc GST	CONTENTS
SHOCK ABSORBERS			
FC42019B	2	41mm Foam Cell Shock	Suits up to 40mm Lift
TORSION BARS			
4WTB-1559	1	Replacement Torsion Bars	30mm/1145mm - 3/99-04 ONLY
Adjust Torsion bars after fitting shocks - Ensure a minimum of 60mm Droop is Maintained			

REAR SUSPENSION

SHOCK ABSORBERS			
FC41200	2	41mm Foam Cell Shock	Check Mounts before ordering Suits Eye/Eye Vehicles
BM401200	2	40mm 9 Stage Adjustable	
FC41201B	2	41mm Foam Cell Shock	Check Mounts before ordering Suits Pin/Eye Vehicles
BM401201	2	40mm 9 Stage Adjustable	
COIL SPRINGS			
TDC290	2	0-300kg Load	OE Height (10/95-99 ONLY)
TDC267	2	0-300kg Load	40mm Lift
TDC267H	2	CONSTANT 300Kg Load	40mm Lift

COMPLETE KIT PRICE REFERENCE

SHOCK CHOICE	SPRING CHOICE	RRP inc GST	CONTENTS
41mm Foam Cell	0-300KG Constant 300kg		
Foam Cell Front Adjustable Rear	0-300KG Constant 300kg		
Includes 2 x Coil Springs 4 x Shocks			

All prices exclude freight. Include only permanent accessories & weights when selecting springs. Towing weight is not included

P: (02) 9672 8899 | F: (02) 9672 8099



HOLDEN

JACKAROO, ISUZU TROOPER

11/81-86

UBS13, 16, 52, 52I



FRONT SUSPENSION

ESTIMATED LIFT: 45 mm

PART NO.	QTY	DESCRIPTION	RRP inc GST	NOTES
SHOCK ABSORBERS				
BD2057T	2	35mm Nitrogen Gas Shock		Suits up to 45mm Lift
FC42057B	2	41mm Foam Cell Shock		Suits up to 45mm Lift
TORSION BARS				
4WTB-1546	1	Replacement Torsion Bars		26mm/926mm
Adjust Torsion bars after fitting shocks - Ensure a minimum of 60mm Droop is Maintained				

REAR SUSPENSION

SHOCK ABSORBERS				
BD1382T	2	35mm Nitrogen Gas Shock		Suits OE Height
FC41382	2	41mm Foam Cell Shock		
BM401382	2	40mm 9 Stage Adjustable		
BD1388T	2	35mm Nitrogen Gas Shock		Suits 45mm Lift
FC41388	2	41mm Foam Cell Shock		
BM401388	2	40mm 9 Stage Adjustable		
LEAF SPRINGS				
FS113	2	0-300kg Load		45mm Lift
FS113H	2	CONSTANT 300Kg Load		45mm Lift
COMPONENTS				
TDUK-004	1	Urethane Shackle Bushing Kit		
TDUB-006	2	U-Bolt Kit		
TDGP-668	1	Greasable Pin Kit		

REPLACEMENT BUSHINGS

QUANTITY PER SHOCK				
TW959	2	Suits Top Front Pin		Pin Style Bushing
412772	1	Suits Bottom Front Eye		Eyering Bushing
404702	2	Suits Top & Bottom Rear Eye		Eyering Bushing

COMPLETE KIT PRICE REFERENCE

SHOCK CHOICE	SPRING CHOICE	RRP inc GST	CONTENTS
35mm Nitro Gas	0-300KG		
41mm Foam Cell	0-300KG Constant 300kg		
Foam Cell Front Adjustable Rear	0-300KG Constant 300kg		
Includes			
2 x Leaf Springs 4 x Shocks 1 x Urethane Kits 2 x U-Bolt Kits			

Fitting sheet (located page 208) must be completed when suspension fitted. Failure to comply may affect warranty.



HOLDEN

JACKAROO, ISUZU TROOPER

11/86-92
UBS16, 17, 52, 55

FRONT SUSPENSION

ESTIMATED LIFT: 45 mm

PART NO.	QTY	DESCRIPTION	RRP inc GST	NOTES
SHOCK ABSORBERS				
BD2057T	2	35mm Nitrogen Gas Shock		Suits up to 45mm Lift
FC42057B	2	41mm Foam Cell Shock		Suits up to 45mm Lift
TORSION BARS				
4WTB-1548	1	Replacement Torsion Bars		26mm/997mm
Adjust Torsion bars after fitting shocks - Ensure a minimum of 60mm Droop is Maintained				

REAR SUSPENSION

SHOCK ABSORBERS				
BD1105T	2	35mm Nitrogen Gas Shock		Suits OE Height
FC41105	2	41mm Foam Cell Shock		
BM401105	2	40mm 9 Stage Adjustable		
BD1106TB	2	35mm Nitrogen Gas Shock		Suits 45mm Lift
FC41106	2	41mm Foam Cell Shock		
BM401106	2	40mm 9 Stage Adjustable		
LEAF SPRINGS				
FS113	2	0-300kg Load		45mm Lift
FS113H	2	CONSTANT 300Kg Load		45mm Lift
COMPONENTS				
TDUK-004	1	Urethane Shackle Bushing Kit		
TDUB-006	2	U-Bolt Kit		
TDGP-668	1	Greasable Pin Kit		

REPLACEMENT BUSHINGS

QUANTITY PER SHOCK				
TW959	2	Suits Top Front Pin		Pin Style Bushing
412772	1	Suits Bottom Front Eye		Eyering Bushing
404702	2	Suits Top & Bottom Rear Eye		Eyering Bushing

COMPLETE KIT PRICE REFERENCE

SHOCK CHOICE	SPRING CHOICE	RRP inc GST	CONTENTS
35mm Nitro Gas	0-300KG		
41mm Foam Cell	0-300KG		
	Constant 300kg		
Foam Cell Front Adjustable Rear	0-300KG		
Includes			
2 x Leaf Springs		4 x Shocks	
1 x Urethane Kits		2 x U-Bolt Kits	

All prices exclude freight. Include only permanent accessories & weights when selecting springs. Towing weight is not included

P: (02) 9672 8899 | F: (02) 9672 8099



HOLDEN

JACKAROO, MONTEREY

5/92-98 & 9/98-04

UBS 25, 26, 69, 73 (INC WIDE BODY)

FRONT SUSPENSION

ESTIMATED LIFT: 40 mm

PART NO.	QTY	DESCRIPTION	RRP inc GST	NOTES
SHOCK ABSORBERS				
FC42019B	2	41mm Foam Cell Shock		Suits up to 40mm Lift
TORSION BARS				
4WTB-1549	1	Replacement Torsion Bars		29.3mm/1220mm
Adjust Torsion bars after fitting shocks - Ensure a minimum of 60mm Droop is Maintained				

REAR SUSPENSION

SHOCK ABSORBERS				
FC41200	2	41mm Foam Cell Shock		Suits up to 40mm Lift
BM401200	2	40mm 9 Stage Adjustable		Suits up to 40mm Lift
COIL SPRINGS				
TDC267	2	0-300kg Load		40mm Lift
TDC267H	2	CONSTANT 300Kg Load		Suit UBS25, 69
TDC267HH	2	CONSTANT 500Kg Load		
TDC267H	2	0-300kg Load		40mm Lift
TDC267HH	2	CONSTANT 300Kg Load		Suit UBS26, 73 Wide Body

REPLACEMENT BUSHINGS

QUANTITY PER SHOCK				
TW959	2	Suits Top Front Pin		Pin Style Bushing
412772	1	Suits Bottom Front Eye		Eyering Bushing

COMPLETE KIT PRICE REFERENCE

SHOCK CHOICE	SPRING CHOICE	RRP inc GST	CONTENTS
41mm Foam Cell	ANY		
Foam Cell Front Adjustable Rear	ANY		
Includes 2 x Coil Springs 4 x Shocks			

Fitting sheet (located page 208) must be completed when suspension fitted. Failure to comply may affect warranty.



HOLDEN

RODEO

1/81-88
KB4, KBD4

FRONT SUSPENSION

ESTIMATED LIFT: 40 mm

PART NO.	QTY	DESCRIPTION	RRP inc GST	NOTES
TORSION BARS				
4WTB-1536	1	Replacement Torsion Bars		26mm/927mm (1/81-83 ONLY)
4WTB-1546	1	Replacement Torsion Bars		26mm/926mm (83-88 ONLY)
Adjust Torsion bars after fitting shocks - Ensure a minimum of 60mm Droop is Maintained				

REAR SUSPENSION

SHOCK ABSORBERS				
BD1382T	2	35mm Nitrogen Gas Shock		Suits OE Height
FC41382	2	41mm Foam Cell Shock		
BM401382	2	40mm 9 Stage Adjustable		
BD1388T	2	35mm Nitrogen Gas Shock		Suits 40mm Lift
FC41388	2	41mm Foam Cell Shock		
BM401388	2	40mm 9 Stage Adjustable		
LEAF SPRINGS				
FS113	2	0-300kg Load		40mm Lift
FS113H	2	CONSTANT 300Kg Load		40mm Lift
FS113HM	2	CONSTANT 500Kg Load		40mm Lift
COMPONENTS				
TDUK-004	1	Urethane Shackle Bushing Kit		
TDUB-006	2	U-Bolt Kit		
TDGS-386	1	Greasable Shackle Kit		
TDGP-668	1	Greasable Pin Kit		

REPLACEMENT BUSHINGS

QUANTITY PER SHOCK				
404702	2	Suits Top & Bottom Rear Eye		Eyering Bushing

COMPLETE KIT PRICE REFERENCE

SHOCK CHOICE	SPRING CHOICE	RRP inc GST	CONTENTS
Nitro Gas Rear	FS113		<p>Includes</p> <ul style="list-style-type: none"> 2 x Leaf Springs 2 x Rear Shocks 1 x Urethane Kit 2 x U-Bolt Kits
	FS113H		
Foam Cell Rear	FS113		
	FS113H		
	FS113HM		
Adjustable Rear	FS113		
	FS113H		
	FS113HM		

All prices exclude freight. Include only permanent accessories & weights when selecting springs. Towing weight is not included

P: (02) 9672 8899 | F: (02) 9672 8099



HOLDEN

RODEO

8/88-03

TFS17, 54,55, (G1,G3,G6,R7) TFS25, 77 (R9)



FRONT SUSPENSION

ESTIMATED LIFT: 40 mm

PART NO.	QTY	DESCRIPTION	RRP inc GST	NOTES
SHOCK ABSORBERS				
BD2057T	2	35mm Nitrogen Gas Shock		Suits up to 40mm Lift
TORSION BARS				
4WTB-1548	1	Replacement Torsion Bars		26mm/997mm - 36mm Spline
4WTB-1566	1	Replacement Torsion Bars		27mm/998mm - 33mm Spline
Check Spline & Diameter prior to ordering				
Adjust Torsion bars after fitting shocks - Ensure a minimum of 60mm Droop is Maintained				

REAR SUSPENSION

SHOCK ABSORBERS				
BD1382T	2	35mm Nitrogen Gas Shock		Suits OE Height
FC41382	2	41mm Foam Cell Shock		
BM401382	2	40mm 9 Stage Adjustable		
BD1388T	2	35mm Nitrogen Gas Shock		Suits 40mm Lift
FC41388	2	41mm Foam Cell Shock		
BM401388	2	40mm 9 Stage Adjustable		
LEAF SPRINGS				
Check No. of Leaves - Rare special editions have heavier leaf packs from factory				
FS113	2	0-300kg Load		40mm Lift
FS113H	2	CONSTANT 300Kg Load		40mm Lift
FS113HM	2	CONSTANT 500Kg Load		40mm Lift
COMPONENTS				
TDUK-065	1	Urethane Shackle Bushing Kit		
TDUB-005	2	U-Bolt Kit		
TDGS-386	1	Greasable Shackle Kit		
TDGP-668	1	Greasable Pin Kit		

REPLACEMENT BUSHINGS

QUANTITY PER SHOCK				
TW959	2	Suits Top Front Pin		Pin Style Bushing
412772	1	Suits Bottom Front Eye		Eyering Bushing
404702	2	Suits Top & Bottom Rear Eye		Eyering Bushing

Fitting sheet (located page 208) must be completed when suspension fitted. Failure to comply may affect warranty.



HOLDEN

RODEO

8/88-03

TFS17, 54,55 (G1,G3,G6,R7) TFS25, 77 (R9)

COMPLETE KIT PRICE REFERENCE

SHOCK CHOICE	SPRING CHOICE	RRP inc GST	CONTENTS
<p>35mm Nitro Gas</p> <p><u>Includes</u> 2x Front Shocks 2x Rear Shocks 2x Leaf Springs 1x Urethane Kit 2x U-Bolt Kits</p>	<p>FS113 0-300KG Spring</p> <p>FS113H CONSTANT 300KG Spring</p>		
<p>Nitro Gas Front Foam Cell Rear</p> <p><u>Includes</u> 2x Front Shocks 2x Rear Shocks 2x Leaf Springs 1x Urethane Kit 2x U-Bolt Kits</p>	<p>FS113 0-300KG Spring</p> <p>FS113H CONSTANT 300KG Spring</p> <p>FS113HM CONSTANT 500KG Spring</p>		
<p>Nitro Gas Front Adjustable Rear</p> <p><u>Includes</u> 2x Front Shocks 2x Rear Shocks 2x Leaf Springs 1x Urethane Kit 2x U-Bolt Kits</p>	<p>FS113 0-300KG Spring</p> <p>FS113H CONSTANT 300KG Spring</p> <p>FS113HM CONSTANT 500KG Spring</p>		

All prices exclude freight. Include only permanent accessories & weights when selecting springs. Towing weight is not included

P: (02) 9672 8899 | F: (02) 9672 8099



HOLDEN

RODEO & COLORADO

2/03-2012
RA-RC



FRONT SUSPENSION

ESTIMATED LIFT: 45 mm

PART NO.	QTY	DESCRIPTION	RRP inc GST	NOTES
SHOCK ABSORBERS				
FC42019B	2	41mm Foam Cell Shock		Suits up to 45mm Lift
TORSION BARS				
4WTB-1559	1	Replacement Torsion Bars		30mm/1145mm
Adjust Torsion bars after fitting shocks - Ensure a minimum of 60mm Droop is Maintained				

REAR SUSPENSION

SHOCK ABSORBERS				
BD1382T	2	35mm Nitrogen Gas Shock		Suits OE Height
FC41382	2	41mm Foam Cell Shock		
BM401382	2	40mm 9 Stage Adjustable		
BD1388T	2	35mm Nitrogen Gas Shock		Suits 45mm Lift
FC41388	2	41mm Foam Cell Shock		
BM401388	2	40mm 9 Stage Adjustable		
LEAF SPRINGS				
FS213	2	0-300kg Load		45mm Lift
FS213H	2	CONSTANT 300Kg Load		45mm Lift
COMPONENTS				
TDUK-065	1	Urethane Shackle Bushing Kit		
TDUB-039	2	U-Bolt Kit		
TDGS-386	1	Greasable Shackle Kit		
TDGP-668	1	Greasable Pin Kit		
AIR ASSIST BAGS				
TDAA-103	1	Bellows bag kit		Suits 45mm Lift

REPLACEMENT BUSHINGS

QUANTITY PER SHOCK				
TW959	2	Suits Top Front Pin		Pin Style Bushing
412772	1	Suits Bottom Front Eye		Eyering Bushing
404702	2	Suits Top & Bottom Rear Eye		Eyering Bushing



Fitting sheet (located page 208) must be completed when suspension fitted. Failure to comply may affect warranty.

HOLDEN

RODEO & COLORADO

2/03-2012
RA-RC

COMPLETE KIT PRICE REFERENCE

SHOCK CHOICE	SPRING CHOICE	RRP inc GST	CONTENTS
<p>Foam Cell Front Nitro Gas Rear</p> <p><u>Includes</u> 2x Front Shocks 2x Rear Shocks 2x Leaf Springs 1x Urethane Kit 2x U-Bolt Kits</p>	<p>FS213 0-300KG Spring</p>		
<p>41mm Foam Cell</p> <p><u>Includes</u> 2x Front Shocks 2x Rear Shocks 2x Leaf Springs 1x Urethane Kit 2x U-Bolt Kits</p>	<p>FS213 0-300KG Spring</p> <p>FS213H CONSTANT 300KG Spring</p>		
<p>Foam Cell Front Adjustable Rear</p> <p><u>Includes</u> 2x Front Shocks 2x Rear Shocks 2x Leaf Springs 1x Urethane Kit 2x U-Bolt Kits</p>	<p>FS213 0-300KG Spring</p> <p>FS213H CONSTANT 300KG Spring</p>		

All prices exclude freight. Include only permanent accessories & weights when selecting springs. Towing weight is not included

HOLDEN

COLORADO

07/12 On

RG, MMU142, GM1700



FRONT SUSPENSION

ESTIMATED LIFT: 40mm

PART NO.	QTY	DESCRIPTION	RRP inc GST	NOTES
SHOCK ABSORBERS				
FC404200	2	40mm Foam Cell Strut		
BM404200	2	40mm Adjustable Strut		9 Stage Adjustable
COIL SPRINGS				
TDC270	2	40mm Lift Spring		Petrol/Diesel/Bar
TDC974	2	40mm Lift Spring		Petrol/Diesel/Bar/Winch
COMPLETE STRUT ASSEMBLY				
HOL-001	2	BM404200/TDC270		Petrol/Diesel/Bar
HOL-002	2	BM404200/TDC974		Petrol/Diesel/Bar/Winch
HOL-003	2	FC404200/TDC270		Petrol/Diesel/Bar
HOL-004	2	FC404200/TDC974		Petrol/Diesel/Bar/Winch
REPLACEMENT STRUT TOP - Strut top special info sheet at toughdog.com.au				
TOY-1081	2	Strut Top		Replacement Strut Top

REAR SUSPENSION

SHOCK ABSORBERS				
BD1382T	2	35mm Nitrogen Gas Shock		Suits Up to 40mm Lift
FC41382	2	41mm Foam Cell Shock		Suits Up to 40mm Lift
BM401382	2	40mm 9 Stage Adjustable		Suits Up to 40mm Lift
LEAF SPRINGS				
FS214C	2	0-300kg Load		40mm Lift
FS214L	2	CONSTANT 300Kg Load		40mm Lift
FS214LL	2	CONSTANT 500Kg Load		40mm Lift
COMPONENTS				
TDUK-071	1	Urethane Shackle Bushing Kit		
TDUB-016	2	U-Bolt Kit		
TDGS-391	1	Greasable Shackle Kit		
TDGP-668	1	Greasable Pin Kit		
TDSK-021	1	Handbrake Relocation kit		Req'd for MY17 vehicles
Handbrake Relocation kit is required for all vehicles MY17 onwards (06/16 release onward)				
AIR ASSIST BAGS				
TDAA-104	1	Bellows bag kit		Suits 40mm Lift
TDAA-118	1	Bellows bag kit		Suits standard height ONLY

REPLACEMENT BUSHINGS

QUANTITY PER SHOCK				
TOY-1081	1	Replacement Strut Top		Available As Complete Unit Only
ADJ300/40	1	Suits Bottom Front Eye		Eyering Bonded Bushing
404702	2	Suits Top & Bottom Rear Eyering		Eyering Bushing

Fitting sheet (located page 208) must be completed when suspension fitted. Failure to comply may affect warranty.

Note: Kit price reference does not include handbrake relocation kit. Please add to kit for MY17 on vehicles

HOLDEN

COLORADO

07/12 On
RG, MMU142, GM1700

COMPLETE KIT PRICE REFERENCE

SHOCK CHOICE	SPRING CHOICE	RRP inc GST	CONTENTS
Foam Cell Struts Require Assembly Includes 2x Front Struts 2x Rear Shocks 2x Front Coils 2x Leaf Springs 1x Urethane Kit 2x U-Bolt Kits	FS214C (Foam Front Gas Rear)		
	FS214C (Foam Cell All) FS214L CONSTANT 300KG FS214LL CONSTANT 500KG		
Foam Cell Complete Assembly Struts Includes 2x Front Strut Assy 2x Rear Shocks 2x Leaf Springs 1x Urethane Kit 2x U-Bolt Kits	FS214C (Foam Front Gas Rear)		
	FS214C (Foam Cell All) FS214L CONSTANT 300KG FS214LL CONSTANT 500KG		
40mm Adjustable Struts Require Assembly Includes 2x Front Struts 2x Rear Shocks 2x Front Coils 2x Leaf Springs 1x Urethane Kit 2x U-Bolt Kits	FS214C 0-300KG		
	FS214L CONSTANT 300KG FS214LL CONSTANT 500KG		
40mm Adjustable Complete Assembly Struts Includes 2x Front Strut Assy 2x Rear Shocks 2x Leaf Springs 1x Urethane Kit 2x U-Bolt Kits	FS214C 0-300KG		
	FS214L CONSTANT 300KG FS214LL CONSTANT 500KG		

All prices exclude freight. Include only permanent accessories & weights when selecting springs. Towing weight is not included

HOLDEN

COLORADO 7/TRAILBLAZER

12/12 On
ALL MODELS



FRONT SUSPENSION

ESTIMATED LIFT: 40mm

PART NO.	QTY	DESCRIPTION	RRP inc GST	NOTES
SHOCK ABSORBERS				
FC404200	2	41mm Foam Cell Strut		
BM404200	2	40mm Adjustable Strut		9 Stage Adjustable
COIL SPRINGS				
TDC270	2	40mm Lift Spring		Petrol/Diesel/Bar
TDC974	2	40mm Lift Spring		Petrol/Diesel/Bar/Winch
COMPLETE STRUT ASSEMBLY				
HOL-001	2	BM404200/TDC270		Petrol/Diesel/Bar
HOL-002	2	BM404200/TDC974		Petrol/Diesel/Bar/Winch
HOL-003	2	FC404200/TDC270		Petrol/Diesel/Bar
HOL-004	2	FC404200/TDC974		Petrol/Diesel/Bar/Winch
REPLACEMENT STRUT TOP				
TOY-1081	2	Strut Top		Replacement Strut Top

REAR SUSPENSION

SHOCK ABSORBERS				
BD1125T	2	35mm Nitrogen Gas Shock		Suits Up to 40mm Lift
FC41125	2	41mm Foam Cell Shock		Suits Up to 40mm Lift
BM401125	2	40mm 9 Stage Adjustable		Suits Up to 40mm Lift
COIL SPRINGS				
TDC271	2	0-300kg Load		40mm Lift
TDC271H	2	CONSTANT 300Kg Load		40mm Lift
AIR ASSIST BAGS				
TDAA-005	1	Coil insert bag kit		Suits 40mm Lift
TDAA-013	1	Coil insert bag kit		Suits standard height ONLY

REPLACEMENT BUSHINGS

QUANTITY PER SHOCK				
TOY-1081	1	Replacement Strut Top		Available As Complete Unit Only
ADJ300/40	1	Suits Bottom Front Eye		Eyering Bonded Bushing
TW040/14	1	Suits Rear Bottom Eye		Eyering Bush
TW959	2	Suits Rear Top Pin		Pin Style Bushing

COMPLETE KIT PRICE REFERENCE

Front Struts available as Complete Assembly

SHOCK CHOICE	SPRING CHOICE	RRP inc GST	CONTENTS
41mm Foam Cell Note: To use gas rear shock for comfort Subtract \$70	Any Any (Complete Assy)		
9 Stage Adjustable	Any Any (Complete Assy)		

Fitting sheet (located page 208) must be completed when suspension fitted. Failure to comply may affect warranty.



HYUNDAI TERRACAN 12/01-08 On HP

FRONT SUSPENSION

ESTIMATED LIFT: 45 mm

PART NO.	QTY	DESCRIPTION	RRP inc GST	NOTES
SHOCK ABSORBERS				
FC42059B	2	41mm Foam Cell Shock		Suits up to 45mm Lift
TORSION BARS				
4WTB-1725	1	Replacement Torsion Bars		27.5mm/1275mm
Adjust Torsion bars after fitting shocks - Ensure a minimum of 60mm Droop is Maintained				

REAR SUSPENSION

SHOCK ABSORBERS				
FC41120B	2	41mm Foam Cell Shock		Suits OE Height
BM401120	2	40mm 9 Stage Adjustable		
FC41121B	2	41mm Foam Cell Shock		Suits 45mm Lift
BM401121	2	40mm 9 Stage Adjustable		
COIL SPRINGS				
TDC680	2	0-300kg Load		45mm Lift
TDC632SL	2	CONSTANT 300Kg Load		45mm Lift

REPLACEMENT BUSHINGS

QUANTITY PER SHOCK				
402267	2	Suits Top Front Pin		Pin Style Bushing
402267	2	Suits Top Rear Pin		Pin Style Bushing
ADJ00191	1	Suits Bottom Rear Eye		Eyering Bushing
412772	1	Suits Bottom Front Eye		Eyering Bushing

COMPLETE KIT PRICE REFERENCE

SHOCK CHOICE	SPRING CHOICE	RRP inc GST	CONTENTS
41mm Foam Cell	Any		
Foam Cell Front Adjustable Rear	Any		
Includes 2 x Coil Springs 4 x Shocks			

All prices exclude freight. Include only permanent accessories & weights when selecting springs. Towing weight is not included

ISUZU

D-MAX

04/08-12

MY09-MY11



FRONT SUSPENSION

ESTIMATED LIFT: 45 mm

PART NO.	QTY	DESCRIPTION	RRP inc GST	NOTES
SHOCK ABSORBERS				
FC42019B	2	41mm Foam Cell Shock		Suits up to 45mm Lift
TORSION BARS				
4WTB-1559	1	Replacement Torsion Bars		30mm/1145mm
Adjust Torsion bars after fitting shocks - Ensure a minimum of 60mm Droop is Maintained				

REAR SUSPENSION

SHOCK ABSORBERS				
BD1382T	2	35mm Nitrogen Gas Shock		Suits OE Height
FC41382	2	41mm Foam Cell Shock		
BM401382	2	40mm 9 Stage Adjustable		
BD1388T	2	35mm Nitrogen Gas Shock		Suits 45mm Lift
FC41388	2	41mm Foam Cell Shock		
BM401388	2	40mm 9 Stage Adjustable		
LEAF SPRINGS				
FS213	2	0-300kg Load		45mm Lift
FS213H	2	CONSTANT 300Kg Load		45mm Lift
COMPONENTS				
TDUK-065	1	Urethane Shackle Bushing Kit		
TDUB-039	2	U-Bolt Kit		
TDGS-386	1	Greasable Shackle Kit		
TDGP-668	1	Greasable Pin Kit		
AIR ASSIST BAGS				
TDAA-103	1	Bellows bag kit		Suits 45mm Lift

REPLACEMENT BUSHINGS

QUANTITY PER SHOCK				
TW959	2	Suits Top Front Pin		Pin Style Bushing
412772	1	Suits Bottom Front Eye		Eyering Bushing
404702	2	Suits Top & Bottom Rear Eye		Eyering Bushing

Fitting sheet (located page 208) must be completed when suspension fitted. Failure to comply may affect warranty.



ISUZU

D-MAX

4/08-12

MY09-MY11

COMPLETE KIT PRICE REFERENCE

SHOCK CHOICE	SPRING CHOICE	RRP inc GST	CONTENTS
<p>Foam Cell Front Nitro Gas Rear</p> <p><u>Includes</u> 2x Front Shocks 2x Rear Shocks 2x Leaf Springs 1x Urethane Kit 2x U-Bolt Kits</p>	<p>FS213 0-300KG Spring</p>		
<p>41mm Foam Cell</p> <p><u>Includes</u> 2x Front Shocks 2x Rear Shocks 2x Leaf Springs 1x Urethane Kit 2x U-Bolt Kits</p>	<p>FS213 0-300KG Spring</p> <p>FS213H CONSTANT 300KG Spring</p>		
<p>Foam Cell Front Adjustable Rear</p> <p><u>Includes</u> 2x Front Shocks 2x Rear Shocks 2x Leaf Springs 1x Urethane Kit 2x U-Bolt Kits</p>	<p>FS213 0-300KG Spring</p> <p>FS213H CONSTANT 300KG Spring</p>		

All prices exclude freight. Include only permanent accessories & weights when selecting springs. Towing weight is not included

P: (02) 9672 8899 | F: (02) 9672 8099



ISUZU

D-MAX

05/12 On

TFS85, V-CROSS, MY12



FRONT SUSPENSION

ESTIMATED LIFT: 40mm

PART NO.	QTY	DESCRIPTION	RRP inc GST	NOTES
SHOCK ABSORBERS				
FC404200	2	40mm Foam Cell Strut		
BM404200	2	40mm Adjustable Strut		9 Stage Adjustable
COIL SPRINGS				
TDC270	2	40mm Lift Spring		Petrol/Diesel/Up to Alloy Bar
TDC974	2	40mm Lift Spring		Petrol/Diesel/Bar
TDC974H	2	40mm Lift Spring		Petrol/Diesel/Bar/Winch
COMPLETE STRUT ASSEMBLY				
HOL-001	2	BM404200/TDC270		Petrol/Diesel/Up to Alloy Bar
HOL-002	2	BM404200/TDC974		Petrol/Diesel/Steel Bar
HOL-005	2	BM404200/TDC974H		Petrol/Diesel/Bar/Winch
HOL-003	2	FC404200/TDC270		Petrol/Diesel/Up to Alloy Bar
HOL-004	2	FC404200/TDC974		Petrol/Diesel/Steel Bar
HOL-006	2	FC404200/TDC974H		Petrol/Diesel/Bar/Winch
REPLACEMENT STRUT TOP				
TOY-1081	2	Strut Top		Replacement Strut Top

REAR SUSPENSION

SHOCK ABSORBERS				
BD1382T	2	35mm Nitrogen Gas Shock		Suits Up to 40mm Lift
FC41382	2	41mm Foam Cell Shock		Suits Up to 40mm Lift
BM401382	2	40mm 9 Stage Adjustable		Suits Up to 40mm Lift
LEAF SPRINGS				
FS214C	2	0-300kg Load		40mm Lift
FS214L	2	CONSTANT 300Kg Load		40mm Lift
FS214LL	2	CONSTANT 500Kg Load		40mm Lift
COMPONENTS				
TDUK-071	1	Urethane Shackle Bushing Kit		
TDUB-016	2	U-Bolt Kit		
TDGS-391	1	Greasable Shackle Kit		
TDGP-668	1	Greasable Pin Kit		
TDSK-021	1	Handbrake Relocation kit		Req'd for up to MY15.5 vehicles
Handbrake Relocation kit is required for all vehicles to MY15.5 (04/16 release) Not req'd for 04/16 onward.				
AIR ASSIST BAGS				
TDAA-104	1	Bellows bag kit		Suits 40mm Lift
TDAA-118	1	Bellows bag kit		Suits standard height ONLY
REPLACEMENT BUSHES (QUANTITY PER SHOCK)				
TOY-1081	1	Replacement Strut Top		Available As Complete Unit Only
ADJ300/40	1	Suits Bottom Front Eye		Eyering Bonded Bushing
404702	2	Suits Top & Bottom Rear Eyering		Eyering Bushing

Fitting sheet (located page 208) must be completed when suspension fitted. Failure to comply may affect warranty.

**Note: Kit price reference includes handbrake relocation kit.
Please remove from kit for MY15.5 on vehicles**





ISUZU

D-MAX

05/12 On

TFS85, V-CROSS, MY12

COMPLETE KIT PRICE REFERENCE

SHOCK CHOICE	SPRING CHOICE	RRP inc GST	CONTENTS
Foam Cell Struts Require Assembly Includes 2x Front Struts 2x Rear Shocks 2x Front Coils 2x Leaf Springs 1x Urethane Kit 2x U-Bolt Kits 1x Handbrake Bkt Kit	FS214C (Foam Front Gas Rear)		
	FS214C (Foam Cell All) FS214L CONSTANT 300KG FS214LL CONSTANT 500KG		
Foam Cell Complete Assembly Struts Includes 2x Front Strut Assy 2x Rear Shocks 2x Leaf Springs 1x Urethane Kit 2x U-Bolt Kits 1x Handbrake Bkt Kit	FS214C (Foam Front Gas Rear)		
	FS214C (Foam Cell All) FS214L CONSTANT 300KG FS214LL CONSTANT 500KG		
40mm Adjustable Struts Require Assembly Includes 2x Front Struts 2x Rear Shocks 2x Front Coils 2x Leaf Springs 1x Urethane Kit 2x U-Bolt Kits 1x Handbrake Bkt Kit	FS214C 0-300KG		
	FS214L CONSTANT 300KG FS214LL CONSTANT 500KG		
40mm Adjustable Complete Assembly Struts Includes 2x Front Struts 2x Rear Shocks 2x Leaf Springs 1x Urethane Kit 2x U-Bolt Kits 1x Handbrake Bkt Kit	FS214C 0-300KG		
	FS214L CONSTANT 300KG FS214LL CONSTANT 500KG		

All prices exclude freight. Include only permanent accessories & weights when selecting springs. Towing weight is not included

P: (02) 9672 8899 | F: (02) 9672 8099



ISUZU

MU-X
8/14 On
MY13 On



FRONT SUSPENSION

ESTIMATED LIFT: 40mm

PART NO.	QTY	DESCRIPTION	RRP inc GST	NOTES
SHOCK ABSORBERS				
FC404200	2	40mm Foam Cell Strut		
BM404200	2	40mm Adjustable Strut		9 Stage Adjustable
COIL SPRINGS				
TDC270	2	40mm Lift Spring		Petrol/Diesel/Up to Alloy Bar
TDC974	2	40mm Lift Spring		Petrol/Diesel/Bar
TDC974H	2	40mm Lift Spring		Petrol/Diesel/Bar/Winch
COMPLETE STRUT ASSEMBLY				
HOL-001	2	BM404200/TDC270		Petrol/Diesel/Up to Alloy Bar
HOL-002	2	BM404200/TDC974		Petrol/Diesel/Steel Bar
HOL-005	2	BM404200/TDC974H		Petrol/Diesel/Bar/Winch
HOL-003	2	FC404200/TDC270		Petrol/Diesel/Up to Alloy Bar
HOL-004	2	FC404200/TDC974		Petrol/Diesel/Steel Bar
HOL-006	2	FC404200/TDC974H		Petrol/Diesel/Bar/Winch
REPLACEMENT STRUT TOP				
TOY-1081	2	Strut Top		Replacement Strut Top





REAR SUSPENSION

SHOCK ABSORBERS				
BD1125T	2	35mm Nitrogen Gas Shock		Suits Up to 40mm Lift
FC41125	2	41mm Foam Cell Shock		Suits Up to 40mm Lift
BM401125	2	40mm 9 Stage Adjustable		Suits Up to 40mm Lift
COIL SPRINGS				
TDC272	2	0-300kg Load		40mm Lift
TDC272H	2	CONSTANT 300Kg Load		40mm Lift
AIR ASSIST BAGS				
TDAA-005	1	Coil insert bag kit		Suits 40mm Lift
TDAA-013	1	Coil insert bag kit		Suits standard height ONLY

REPLACEMENT BUSHINGS

QUANTITY PER SHOCK				
TOY-1081	1	Replacement Strut Top		Available As Complete Unit Only
ADJ300/40	1	Suits Bottom Front Eye		Eyering Bonded Bushing
TW040/14	1	Suits Rear Bottom Eye		Eyering Bush
TW959	2	Suits Rear Top Pin		Pin Style Bushing

Fitting sheet (located page 208) must be completed when suspension fitted. Failure to comply may affect warranty.

SHOCK CHOICE	SPRING CHOICE	RRP inc GST	CONTENTS
Foam Cell Struts Require Assembly <u>Includes</u> 4 x Coil Springs 4 x Shocks	ANY (Foam Front Gas Rear)		
	ANY (Foam Cell All)		
Foam Cell Complete Assembly Struts <u>Includes</u> 2 x Front Strut Assy 2 x Coil Springs 2 x Rear Shocks	ANY (Foam Front Gas Rear)		
	ANY (Foam Cell All)		
40mm Adjustable Struts Require Assembly <u>Includes</u> 4 x Coil Springs 4 x Shocks	ANY		
40mm Adjustable Complete Assembly Struts <u>Includes</u> 2 x Front Strut Assy 2 x Coil Springs 2 x Rear Shocks	ANY		

All prices exclude freight. Include only permanent accessories & weights when selecting springs. Towing weight is not included

JEEP CHEROKEE

4/94-01
XJ Limited, Sport

**Note: Transmission spacer
fitting instructions available
at toughdog.com.au**



FRONT SUSPENSION

ESTIMATED LIFT: 35 mm

PART NO.	QTY	DESCRIPTION	RRP inc GST	NOTES
SHOCK ABSORBERS				
FC41063	2	41mm Foam Cell Shock		Suits OE Height
BM401063	2	40mm 9 Stage Adjustable		
FC41068	2	41mm Foam Cell Shock		Suits 35mm Lift
BM401068	2	40mm 9 Stage Adjustable		
COIL SPRINGS				
TDC333	2	35mm Lift		Petrol/Diesel/Bar
TDC352	2	35mm Lift		Petrol/Diesel/Bar/Winch
STEERING DAMPERS				
SS5922-P/S	1	Return to Centre Damper		Power Steering
SV5922	1	9 Stage Adjustable Damper		

REAR SUSPENSION

SHOCK ABSORBERS				
FC41241	2	41mm Foam Cell Shock		Suits OE Height
BM401241	2	40mm 9 Stage Adjustable		
FC41249	2	41mm Foam Cell Shock		Suits 35mm Lift
BM401249	2	40mm 9 Stage Adjustable		
LEAF SPRINGS				
FS025H	2	0-300kg Load		35mm Lift
COMPONENTS				
TDUK-027	1	Urethane Shackle Bushes		
TDUB-027	2	U-bolt Kit		
TDSP-002	1	Transmission Spacer		

REPLACEMENT BUSHINGS

QUANTITY PER SHOCK				
TW959	2	Suits Top Front Pin		Pin Style Bushing
404702	1	Suits Bottom Rear Eye		Eyering Bushing

Bar Pin Style Bushings are not User Servicable - Contact 4Way Suspension for Replacement Service

COMPLETE KIT PRICE REFERENCE

SHOCK CHOICE	SPRING CHOICE	RRP inc GST	CONTENTS
41mm Foam Cell	ANY		
9 Stage Adjustable	ANY		
Includes 2 x Coil Springs 4 x Shocks 2 x Leaf Springs 2 x U-Bolts 1 x Urethane kit 1 x Transmission Spacer			

Fitting sheet (located page 208) must be completed when suspension fitted. Failure to comply may affect warranty.



JEEP

GRAND CHEROKEE

ZG - 4/96-99
WG, WJ - 6/99-05

FRONT SUSPENSION

ESTIMATED LIFT: 30mm

PART NO.	QTY	DESCRIPTION	RRP inc GST	NOTES
SHOCK ABSORBERS				
FC41068	2	41mm Foam Cell Shock		
BM401068	2	40mm Adjustable Shock		9 Stage Adjustable
COIL SPRINGS				
TDC358	2	40mm Lift Spring		30mm Lift-ZG 4/96-99 ONLY
TDC360	2	40mm Lift Spring		30mm Lift-WG, WJ 6/99-05 ONLY
STEERING DAMPERS				
SS5922-P/S	1	Return to Centre Damper		
SV5922	1	9 Stage Adjustable Damper		ZG 4/96-99 ONLY
SS5924-P/S	1	Return to Centre Damper		
SV5924	1	9 Stage Adjustable Damper		WG, WJ 6/99-05 ONLY

REAR SUSPENSION

SHOCK ABSORBERS				
FC41444	2	41mm Foam Cell Shock		ZG 4/96-99 ONLY
BM401444	2	40mm 9 Stage Adjustable		Suits up to 30mm Lift
FC41190	2	41mm Foam Cell Shock		WG, WJ 6/99-05 ONLY
BM401190	2	40mm 9 Stage Adjustable		Suits up to 30mm Lift
COIL SPRINGS				
TDC359	2	0-300kg Load		30mm Lift-ZG 4/96-99 ONLY
TDC361	2	0-300kg Load		30mm Lift-WG, WJ 6/99-05 ONLY

REPLACEMENT BUSHINGS

QUANTITY PER SHOCK				
TW959	2	Suits Top Front Pin		Pin Style Bushing
404702	1	Suits Top Rear Eye (ZG)		Eyering Bushing
Bar Pin Style Bushings are not User Servicable - Contact 4Way Suspension for Replacement Service				

COMPLETE KIT PRICE REFERENCE

SHOCK CHOICE	SPRING CHOICE	RRP inc GST	CONTENTS
41mm Foam Cell	Any		
9 Stage Adjustable	Any		
Includes 4 x Coil Springs 4 x Shocks			

All prices exclude freight. Include only permanent accessories & weights when selecting springs. Towing weight is not included

P: (02) 9672 8899 | F: (02) 9672 8099



JEEP WRANGLER 10/96-07 TJ

Note: Transmission spacer fitting instructions available at toughdog.com.au



FRONT SUSPENSION

ESTIMATED LIFT: 45mm

PART NO.	QTY	DESCRIPTION	RRP inc GST	NOTES
SHOCK ABSORBERS				
BD1063T	2	35mm Nitro Gas Shocks		Suits OE Height
BM401063	2	40mm Adjustable Shock		
BD1068T	2	35mm Nitro Gas Shocks		Suits 45mm Lift
BM401068	2	40mm Adjustable Shock		
COIL SPRINGS				
TDC354	2	40mm Lift Spring		Suits up to Bullbar (45mm Lift)
STEERING DAMPERS				
SS5922-P/S	1	Return to Centre Damper		Power Steering
SV5922	1	9 Stage Adjustable Damper		
TRANSMISSION SPACERS				
TDSP-001	1	Transmission Spacer		Man & Auto - 10/96-03 ONLY
TDSP-005	1	Transmission Spacer		Auto - 03-07 ONLY
TDSP-006	1	Transmission Spacer		Manual - 03-07 ONLY

REAR SUSPENSION

SHOCK ABSORBERS				
BD1443T	2	35mm Nitro Gas Shocks		Suits OE Height
BM401443	2	40mm Adjustable Shock		
BD1461T	2	35mm Nitro Gas Shocks		Suits 45mm Lift
BM401461	2	40mm Adjustable Shock		
COIL SPRINGS				
TDC355	2	0-300kg Load		45mm Lift

REPLACEMENT BUSHINGS

QUANTITY PER SHOCK				
TW959	2	Suits Top Front Pin		Pin Style Bushing
Bar Pin Style Bushings are not User Servicable - Contact 4Way Suspension for Replacement Service				

COMPLETE KIT PRICE REFERENCE

SHOCK & SPRING	SPACER	RRP inc GST	CONTENTS
35mm Nitro Gas Any Spring	TDSP-001		
	TDSP-005		
	TDSP-006		
9 Stage Adjustable Any Spring	TDSP-001		
	TDSP-005		
	TDSP-006		
Includes 4 x Coil Springs 4 x Shocks 1 x Transmission Spacer			

Fitting sheet (located page 208) must be completed when suspension fitted. Failure to comply may affect warranty.



JEEP WRANGLER

3/07-18 On
JK

FRONT SUSPENSION

ESTIMATED LIFT: 40 mm

PART NO.	QTY	DESCRIPTION	RRP inc GST	NOTES
SHOCK ABSORBERS				
BM401069	2	40mm Adjustable Shock		Suits up to 40mm Lift
COIL SPRINGS				
TDC331	2	40mm Lift Spring		Petrol SWB - Up to bullbar
TDC332	2	40mm Lift Spring		Petrol SWB - Bullbar & Winch
TDC337	2	40mm Lift Spring		Petrol LWB - Up To Bullbar
TDC338	2	40mm Lift Spring		Petrol LWB - Bullbar & Winch
TDC332	2	40mm Lift Spring		Diesel SWB - Up to Bullbar
TDC338	2	40mm Lift Spring		Diesel SWB - Bullbar & Winch
TDC338	2	40mm Lift Spring		Diesel LWB - Up to Bullbar
TDC342	2	40mm Lift Spring		Diesel LWB - Bullbar & Winch
STEERING DAMPERS				
SV5926	1	9 Stage Adjustable Damper		instructions at toughdog.com.au
PANHARD RODS				
TDPR-017	1	Adjustable Panhard Rod		

REAR SUSPENSION

SHOCK ABSORBERS				
BM401463	2	40mm 9 Stage Adjustable Shock		Suits 40mm Lift
COIL SPRINGS				
TDC340	2	0-300kg Load		40mm Lift (suits SWB only)
TDC339	2	CONSTANT 300Kg Load SWB		40mm Lift (also 0-300kg for LWB)
TDC341	2	CONSTANT 300Kg Load LWB		40mm Lift

REPLACEMENT BUSHINGS

QUANTITY PER SHOCK				
TW959	2	Suits Top Front Pin		Pin Style Bushing
4W-SPF420-04	1	Suits Bottom Front Eying		Eying Bushing

Bar Pin Style Bushings (rear) are not User Servicable - Contact 4Way Suspension for Replacement Service

COMPLETE KIT PRICE REFERENCE

SHOCK CHOICE	SPRING CHOICE	RRP inc GST	CONTENTS
9 Stage Adjustable	Any		
<p align="center">Includes 4 x Coil Springs 4 x Shocks</p>			

All prices exclude freight. Include only permanent accessories & weights when selecting springs. Towing weight is not included

P: (02) 9672 8899 | F: (02) 9672 8099



JEEP WRANGLER

08/18 On
JL



FRONT SUSPENSION

ESTIMATED LIFT: 50 mm

PART NO.	QTY	DESCRIPTION	RRP inc GST	NOTES
SHOCK ABSORBERS				
FC43028	2	40mm Foam Cell Shock		Suits up to 50mm Lift
BM403028	2	40mm 9 Stage Adjustable Shock		Suits up to 50mm Lift
COIL SPRINGS				
TDC1018	2	40mm Lift Spring		Diesel LWB - Up to Bullbar
TDC1019	2	40mm Lift Spring		Diesel LWB - Bullbar & Winch
STEERING DAMPERS				
SV5929	1	9 Stage Adjustable Damper		instructions at toughdog.com.au
PANHARD RODS				
TDPR-022	1	Adjustable Panhard Rod		

REAR SUSPENSION

SHOCK ABSORBERS				
FC43029	2	40mm Foam Cell Shock		Suits 50mm Lift
BM43029	2	40mm 9 Stage Adjustable Shock		Suits 50mm Lift
COIL SPRINGS				
TDC1020	2	0-150kg Load		50mm Lift
TDC1021	2	CONSTANT 150-300Kg Load		50mm Lift

COMPLETE KIT PRICE REFERENCE

SHOCK CHOICE	SPRING CHOICE	RRP inc GST	CONTENTS
41mm Foam Cell	Any		
9 Stage Adjustable	Any		
<u>Includes</u> 4 x Coil Springs 4 x Shocks			

Fitting sheet (located page 208) must be completed when suspension fitted. Failure to comply may affect warranty.



COMING SOON IN
2020!

JEEP
WRANGLER
2020 ON
GLADIATOR

FRONT SUSPENSION

ESTIMATED LIFT:

PART NO.	QTY	DESCRIPTION	RRP inc GST	NOTES
SHOCK ABSORBERS				
	2	41mm Foam Cell Shock		Suits up to 50mm Lift
	2	40mm 9 Stage Adjustable Shock		Suits up to 50mm Lift
COIL SPRINGS				
	2	40mm Lift Spring		Diesel LWB - Up to Bullbar
	2	40mm Lift Spring		Diesel LWB - Bullbar & Winch
STEERING DAMPERS				
	1	9 Stage Adjustable Damper		instructions at toughdog.com.au
PANHARD RODS				
	1	Adjustable Panhard Rod		

REAR SUSPENSION

SHOCK ABSORBERS				
	2	41mm Foam Cell Shock		Suits 50mm Lift
	2	40mm 9 Stage Adjustable Shock		Suits 50mm Lift
COIL SPRINGS				
	2	0-150kg Load		50mm Lift
	2	CONSTANT 150-300Kg Load		50mm Lift

COMPLETE KIT PRICE REFERENCE

SHOCK CHOICE	SPRING CHOICE	RRP inc GST	CONTENTS
41mm Foam Cell	Any		
9 Stage Adjustable	Any		
Includes 4 x Coil Springs 4 x Shocks			

All prices exclude freight. Include only permanent accessories & weights when selecting springs. Towing weight is not included

P: (02) 9672 8899 | F: (02) 9672 8099



LAND ROVER

80, 88 SWB, 109 LWB

53-83

SERIES I, II, IIA & III



FRONT SUSPENSION

ESTIMATED LIFT: No Springs Avail.

PART NO.	QTY	DESCRIPTION	RRP inc GST	NOTES
SHOCK ABSORBERS				
BD2000T	2	35mm Nitro Gas Shocks		Suits up to 50mm Lift
FC42000	2	41mm Foam Cell Shocks		Suits up to 50mm Lift
STEERING DAMPERS				
EXT5000	1	H/Duty Steering Damper		Suits SI, II, IIA & III
SS5000-M/S	1	Return to Centre Damper		Suits Series I ONLY
SV5000	1	9 Stage Adjustable Damper		Suits SII, IIA, III ONLY

REAR SUSPENSION

SHOCK ABSORBERS				
BD3005T	2	35mm Nitro Gas Shocks		Suits '53-83 SI, II, IIA, III SWB
FC43005	2	41mm Foam Cell Shock		And '53-58 SI LWB
BD1399T	2	35mm Nitro Gas Shocks		Suits '58-83 SII, III LWB
FC41399	2	41mm Foam Cell Shock		

REPLACEMENT BUSHINGS

QUANTITY PER SHOCK				
4W-SPF390	2	Suits Top & Bottom Front Eye		Eye Ring Bushing
4W-SPF390	2	Suits Top & Bottom Rear Eying		Eying Bushing for #3005 shocks
4W-SPF390	1	Suits Top Eye Mount		Eying Busing for #1399 shocks
TW959	2	Suits Bottom Rear Pin Mount		Pin Bushing for #1399 shocks

Fitting sheet (located page 208) must be completed when suspension fitted. Failure to comply may affect warranty.



LAND ROVER

DEFENDER

11/84-91
110 COUNTY ONLY

FRONT SUSPENSION

ESTIMATED LIFT: 30 mm

PART NO.	QTY	DESCRIPTION	RRP inc GST	NOTES
SHOCK ABSORBERS				
FC41049	2	41mm Foam Cell Shocks		Suits up to 30mm Lift
BM401049	2	40mm Adjustable Shock		Suits up to 30mm Lift
BMX1049/2	2	45mm Adjustable Shock		Suits up to 30mm Lift
TDR1049B	2	53mm 'Ralph' Shock		Suits up to 30mm Lift
COIL SPRINGS				
TDC511	2	30mm Lift Spring		Suits Petrol with Bar
TDC513	2	30mm Lift Spring		Suits Diesel with Bar
TDC508H	2	30mm Lift Spring		Suits All with bar & Winch
STEERING DAMPERS				
EXT5009	1	H/Duty Steering Damper		
SS5009-P/S	1	Return to Centre Damper		
SV5009	1	9 Stage Adjustable Damper		
PANHARD RODS				
TDPR-002	1	Panhard Rod (14mm Sleeve)		Up to Chassis #2A626645
TDPR-018	1	Panhard Rod (16mm Sleeve)		Up to Chassis #2A626646

REAR SUSPENSION

SHOCK ABSORBERS				
FC41397	2	41mm Foam Cell Shocks		Suits up to 30mm Lift
BM401397	2	40mm Adjustable Shock		Fit this part number if the lower rubber bushes are conical in shape & fit into a metal housing.
BMX1397/2	2	45mm Adjustable Shock		
TDR1397B	2	53mm 'Ralph' Shock		
FC41398	2	41mm Foam Cell Shocks		
BM401398	2	40mm Adjustable Shock		Fit this part number if the lower rubber bushes are flat & approx. 45mm in diameter
BMX1398/2	2	45mm Adjustable Shock		
TDR1398	2	53mm 'Ralph' Shock		
TDC512	2	0-300kg Load		
TDC512HH	2	CONSTANT 300Kg Load		30mm Lift
COIL SPRINGS				

REPLACEMENT BUSHINGS

QUANTITY PER SHOCK				
TW957	4	Suits Top & Bottom Front Pin		
TW967	2	Suits Bottom Rear Pin		Pin Style Bushing #1397 Shocks
415024	1	Suits Top Rear Eye		Eyering Bushing #1397 Shocks
ADJ00191	1	Suits Top Rear Eye		Eyering Bushing #1398 Shocks
TW957	2	Suits Bottom Rear Pin		Pin Style Bushing #1398 Shocks

All prices exclude freight. Include only permanent accessories & weights when selecting springs. Towing weight is not included

P: (02) 9672 8899 | F: (02) 9672 8099



LAND ROVER

DEFENDER

92-16 On

90, 110, 130 Series



FRONT SUSPENSION

ESTIMATED LIFT: 30mm

PART NO.	QTY	DESCRIPTION	RRP inc GST	NOTES
SHOCK ABSORBERS				
FC41049	2	41mm Foam Cell Shocks		Suits up to 30mm Lift
BM401049	2	40mm Adjustable Shock		Suits up to 30mm Lift
BMX1049/2	2	45mm Adjustable Shock		Suits up to 30mm Lift
TDR1049B	2	53mm 'Ralph' Shock		Suits up to 30mm Lift
COIL SPRINGS				
TDC505	2	30mm Lift Spring		Suits 90 S Petrol with Bar
TDC535	2	30mm Lift Spring		Suits 90 S Petrol Bar/Winch Or Dies with Bar
TDC504	2	30mm Lift Spring		Suits 90 Series with Bar & Winch
TDC520	2	30mm Lift Spring		Suits 110, 130 with Bar
TDC514	2	30mm Lift Spring		Suits 110, 130 with Bar & Winch
STEERING DAMPERS				
EXT5009	1	H/Duty Steering Damper		
SS5009-P/S	1	Return to Centre Damper		
SV5009	1	9 Stage Adjustable Damper		
PANHARD RODS				
TDPR-002	1	Panhard Rod (14mm Sleeve)		Up to Chassis #2A626645
TDPR-018	1	Panhard Rod (16mm Sleeve)		Up to Chassis #2A626646
TDUK-028	1	Replacement Bushes - TDPR-002		2 bushes in kit
TDUK-029	1	Replacement Bushes - TDPR-018		2 bushes in kit

REAR SUSPENSION

SHOCK ABSORBERS				
FC41397	2	41mm Foam Cell Shocks		Suits up to 30mm Lift
BM401397	2	40mm Adjustable Shock		Fit this part number if the lower rubber bushes are conical in shape & fit into a metal housing.
BMX1397/2	2	45mm Adjustable Shock		
TDR1397B	2	53mm 'Ralph' Shock		
FC41398	2	41mm Foam Cell Shocks		Suits up to 30mm Lift
BM401398	2	40mm Adjustable Shock		Fit this part number if the lower rubber bushes are flat & approx. 45mm in diameter
BMX1398/2	2	45mm Adjustable Shock		
TDR1398	2	53mm 'Ralph' Shock		
COIL SPRINGS				
TDC518	2	0-300kg Load		30mm Lift - Suit 90s SWB
TDC518H	2	CONSTANT 300Kg Load		30mm Lift - Suit 90s SWB
TDC504	2	CONSTANT 500Kg Load		30mm Lift - Suit 90s SWB
TDC536	2	0-300kg Load		30mm Lift - Suit 110s
TDC523	2	0-500kg Load		30mm Lift - Suit 130s LWB
TDC522H	2	CONSTANT 500Kg Load		30mm Lift - Suit 130s LWB

REPLACEMENT BUSHINGS

FOR REPLACEMENT BUSHING PART NUMBERS, PLEASE SEE
LAND ROVER DEFENDER 110 COUNTY ON PREVIOUS PAGE





Fitting sheet (located page 208) must be completed when suspension fitted. Failure to comply may affect warranty.

LAND ROVER

DEFENDER

92-16 On
90, 110, 130 Series

COMPLETE KIT PRICE REFERENCE

SHOCK CHOICE	SPRING CHOICE	RRP inc GST	CONTENTS
41mm Foam Cell Includes 2x Front shocks 2x Rear Shocks 2x Front Coils 2x Rear Coils	\$ 140 Coil (Front & Rear) \$ 170 Rear Coil \$ 190 Rear Coil \$ 220 Rear Coil		
40mm Adjustable Includes 2x Front shocks 2x Rear Shocks 2x Front Coils 2x Rear Coils	\$ 140 Coil (Front & Rear) \$ 170 Rear Coil \$ 190 Rear Coil \$ 220 Rear Coil		
45mm Big Bore Adjustable Includes 2x Front shocks 2x Rear Shocks 2x Front Coils 2x Rear Coils	\$ 140 Coil (Front & Rear) \$ 170 Rear Coil \$ 190 Rear Coil \$ 220 Rear Coil		
53mm 'Ralph' Big Bore Includes 2x Front shocks 2x Rear Shocks 2x Front Coils 2x Rear Coils	\$ 140 Coil (Front & Rear) \$ 170 Rear Coil \$ 190 Rear Coil \$ 220 Rear Coil		

All prices exclude freight. Include only permanent accessories & weights when selecting springs. Towing weight is not included

P: (02) 9672 8899 | F: (02) 9672 8099



LAND ROVER

DISCOVERY

4/91-99

SERIES I



FRONT SUSPENSION

ESTIMATED LIFT: 30mm

PART NO.	QTY	DESCRIPTION	RRP inc GST	NOTES
SHOCK ABSORBERS				
FC41049	2	41mm Foam Cell Shocks		Suits up to 30mm Lift
BM401049	2	40mm Adjustable Shock		Suits up to 30mm Lift
BMX1049/2	2	45mm Adjustable Shock		Suits up to 30mm Lift
TDR1049B	2	53mm 'Ralph' Shock		Suits up to 30mm Lift
COIL SPRINGS				
TDC505	2	30mm Lift Spring		Suits All with Bar
TDC504	2	30mm Lift Spring		Suits All with Bar & Winch
STEERING DAMPERS				
EXT5000	1	H/Duty Steering Damper		
SS5000-P/S	1	Return to Centre Damper		Power Steering
SV5000	1	9 Stage Adjustable Damper		
PANHARD RODS				
TDPR-002	1	Panhard Rod (14mm Sleeve)		Up to Chassis #2A626645

REAR SUSPENSION

SHOCK ABSORBERS				
FC41397	2	41mm Foam Cell Shocks		Suits up to 30mm Lift
BM401397	2	40mm Adjustable Shock		Fit this part number if the lower rubber bushes are conical in shape & fit into a metal housing.
BMX1397/2	2	45mm Adjustable Shock		
TDR1397B	2	53mm 'Ralph' Shock		
FC41398	2	41mm Foam Cell Shocks		
BM401398	2	40mm Adjustable Shock		Fit this part number if the lower rubber bushes are flat & approx. 45mm in diameter
BMX1398/2	2	45mm Adjustable Shock		
TDR1398	2	53mm 'Ralph' Shock		
COIL SPRINGS				
TDC518	2	0-300kg Load		30mm Lift
TDC518H	2	CONSTANT 300Kg Load		30mm Lift

REPLACEMENT BUSHINGS

QUANTITY PER SHOCK				
TW967	2	Suits Bottom & Top Front Pin		Pin Style Bushing #1397 Shocks
415024	1	Suits Top Front Eye		Eyering Bushing #1397 Shocks
ADJ00191	1	Suits Top Rear Eye		Eyering Bushing #1398 Shocks
TW957	2	Suits Bottom Rear Pin		Pin Style Bushing #1398 Shocks
TW957	4	Suits Front Shock Top & Bottom		Pin Style Bushing #1049 Shocks





Fitting sheet (located page 208) must be completed when suspension fitted. Failure to comply may affect warranty.

LAND ROVER

DISCOVERY

4/91-99
SERIES I

COMPLETE KIT PRICE REFERENCE

SHOCK CHOICE	SPRING CHOICE	RRP inc GST	CONTENTS
<p>41mm Foam Cell</p> <p><u>Includes</u> 2x Front shocks 2x Rear Shocks 2x Front Coils 2x Rear Coils</p>	ANY		
<p>40mm Adjustable</p> <p><u>Includes</u> 2x Front shocks 2x Rear Shocks 2x Front Coils 2x Rear Coils</p>	ANY		
<p>45mm Big Bore Adjustable</p> <p><u>Includes</u> 2x Front shocks 2x Rear Shocks 2x Front Coils 2x Rear Coils</p>	ANY		
<p>53mm 'Ralph' Big Bore</p> <p><u>Includes</u> 2x Front shocks 2x Rear Shocks 2x Front Coils 2x Rear Coils</p>	ANY		

All prices exclude freight. Include only permanent accessories & weights when selecting springs. Towing weight is not included

P: (02) 9672 8899 | F: (02) 9672 8099



LAND ROVER

DISCOVERY

SERIES II (3/99 - 4/05)

SERIES III (4/05-2009)



FRONT SUSPENSION

ESTIMATED LIFT: 35mm

PART NO.	QTY	DESCRIPTION	RRP inc GST	NOTES
SHOCK ABSORBERS				
FC41043	2	41mm Foam Cell Shock		Suits up to 35mm Lift (S2 ONLY)
BM401043	2	40mm Adjustable Shock		Suits up to 35mm Lift (S2 ONLY)
COIL SPRINGS				
TDC530	2	35mm Lift Spring		Suits S2 with Bar
TDC530H	2	35mm Lift Spring		Suits S2 with Bar & Winch
TDC545	2	40mm Lift Spring		Suits S3 with Bar
TDC545H	2	40mm Lift Spring		Suits S3 with Bar & Winch
STEERING DAMPERS				
EXT5003	1	H/Duty Steering Damper		(S2 ONLY)
SS5003-P/S	1	Return to Centre Damper		(S2 ONLY) Power Steering
SV5003	1	9 Stage Adjustable Damper		(S2 ONLY)

REAR SUSPENSION

SHOCK ABSORBERS				
FC41396	2	41mm Foam Cell Shock		Suits up to 35mm Lift (S2 ONLY)
BM401396	2	40mm Adjustable Shock		Suits up to 35mm Lift (S2 ONLY)
COIL SPRINGS				
TDC508	2	0-300kg Load		35mm Lift (S2 ONLY)
TDC508H	2	CONSTANT 300Kg Load		35mm Lift (S2 ONLY)
TDC546	2	0-300kg Load		40mm Lift (S3 ONLY)
TDC546H	2	CONSTANT 300Kg Load		40mm Lift (S3 ONLY)

**PLEASE TAKE CAREFUL NOTE OF PARTS SUITABILITY FOR SERIES II AND SERIES III
SERIES II PARTS ARE NOT COMPATIBLE WITH SERIES III VEHICLES**

COMPLETE KIT PRICE REFERENCE

SHOCK CHOICE	SPRING CHOICE	RRP inc GST	CONTENTS
41mm Foam Cell	All \$ 140 Coils		
	\$ 170 Rear Coils		
9 Stage Adjustable	All \$ 140 Coils		
	\$170 Rear Coils		
<p>Includes 4 x Coil Springs 4 x Shocks</p>			

Fitting sheet (located page 208) must be completed when suspension fitted. Failure to comply may affect warranty.



LAND ROVER

RANGE ROVER 'CLASSIC'

6/72-4/95

NON AIR SUSPENSION

FRONT SUSPENSION

ESTIMATED LIFT: 35 mm

PART NO.	QTY	DESCRIPTION	RRP inc GST	NOTES
SHOCK ABSORBERS				
FC41049	2	41mm Foam Cell Shock		Suits up to 35mm Lift
BM401049	2	40mm Adjustable Shock		Suits all models without Air Suspension (6/72-94)
BMX1049/2	2	45mm Adjustable Shock		
TDR1049B	2	53mm 'Ralph' Shock		
COIL SPRINGS (Non Air Suspension Models Only)				
TDC501	2	O.E Height Spring		Suits Petrol with Bar
TDC505	2	35mm Lift Spring		Suits Diesel with Bar
TDC504	2	35mm Lift Spring		Suits All with Bar & Winch
STEERING DAMPERS				
EXT5000	1	H/Duty Steering Damper		Power Steering
SS5000-P/S	1	Return to Centre Damper		
SV5000	1	9 Stage Adjustable Damper		
PANHARD RODS				
TDPR-002	1	Panhard Rod (14mm Sleeve)		
TDPR-018	1	Panhard Rod (16mm Sleeve)		

REAR SUSPENSION

SHOCK ABSORBERS				
FC41398	2	41mm Foam Cell Shock		Suits up to 35mm Lift
BM401398	2	40mm Adjustable Shock		Suits all models without Air Suspension (6/72-94)
BMX1398/2	2	45mm Adjustable Shock		
TDR1398	2	53mm 'Ralph' Shock		
COIL SPRINGS				
TDC502	2	0-300kg Load		Suits OE Height Only
TDC504	2	0-300kg Load		35mm Lift
TDC508	2	CONSTANT 300Kg Load		35mm Lift
TDC508H	2	CONSTANT 500Kg Load		35mm Lift

COMPLETE KIT PRICE REFERENCE

FOR REPLACEMENT BUSHING PART NUMBERS, PLEASE SEE LAND ROVER DEFENDER 110 COUNTY ON PAGE 59

SHOCK CHOICE	SPRING CHOICE	RRP inc GST	CONTENTS
41mm Foam Cell	ANY		
9 Stage Adjustable	ANY		
9 Stage Adjustable 45mm Big Bore	ANY		
53mm 'Ralph'	ANY		
Includes 4 x Coil Springs 4 x Shocks			

All prices exclude freight. Include only permanent accessories & weights when selecting springs. Towing weight is not included

P: (02) 9672 8899 | F: (02) 9672 8099



LAND ROVER

RANGE ROVER

5/95-00

WITH AIR SUSPENSION



FRONT SUSPENSION

ESTIMATED LIFT: AIR SYSTEM

PART NO.	QTY	DESCRIPTION	RRP inc GST	NOTES
SHOCK ABSORBERS				
FC41008	2	41mm Foam Cell Shock		Suits up to 35mm Lift
BM401008	2	40mm Adjustable Shock		Suits all models with Air Suspension (5/95-00)
BMX1008/2	2	45mm Adjustable Shock		
TDR1008	2	53mm 'Ralph' Shock		
STEERING DAMPERS				
EXT5000	1	H/Duty Steering Damper		Power Steering
SS5000-P/S	1	Return to Centre Damper		
SV5000	1	9 Stage Adjustable Damper		
PANHARD RODS				
TDPR-002	1	Panhard Rod (14mm Sleeve)		

REAR SUSPENSION

SHOCK ABSORBERS				
FC41397	2	41mm Foam Cell Shock		Suits up to 35mm Lift
BM401397	2	40mm Adjustable Shock		Suits all models with Air Suspension (5/95-00)
BMX1397/2	2	45mm Adjustable Shock		
TDR1397	2	53mm 'Ralph' Shock		

REPLACEMENT BUSHINGS

QUANTITY PER SHOCK				
TW957	2	Suits Top & Bottom Front Pin		Pin Style Bushing #1008 Shocks
415024	1	Suits Top Rear Eye		Eyering Bushing #1397 Shocks
TW967	2	Suits Bottom Rear Pin		Pin Style Bushing #1397 Shocks

Fitting sheet (located page 208) must be completed when suspension fitted. Failure to comply may affect warranty.

LADA

NIVA

7/83-98
ALL



FRONT SUSPENSION

ESTIMATED LIFT: 25 mm

PART NO.	QTY	DESCRIPTION	RRP inc GST	NOTES
SHOCK ABSORBERS				
BD2006T	2	35mm Nitro Gas Shocks		Suits up to 25mm Lift
COIL SPRINGS				
TDC402	2	25mm Lift Spring		All Applications

REAR SUSPENSION

SHOCK ABSORBERS				
BD3020T	2	35mm Nitro Gas Shocks		Suits up to 25mm Lift
COIL SPRINGS				
TDC403	2	25mm Lift Spring		All Applications

REPLACEMENT BUSHINGS

QUANTITY PER SHOCK				
TW959	4	Suits Top Front Pin		Pin Style Bush
412773	1	Suits Bottom Front Eye		Eyering Bush
404702	1	Suits Top Rear Eye		Eyering Bush
4W-SPF420-02	1	Suits Bottom Rear Eye		Eye Style Bus

COMPLETE KIT PRICE REFERENCE

SHOCK CHOICE	SPRING CHOICE	RRP inc GST	CONTENTS
35mm Nitro Gas	ANY		
Includes 4 x Coil Springs 4 x Shocks			

All prices exclude freight. Include only permanent accessories & weights when selecting springs. Towing weight is not included

LDV

T60

2017 On

ALL

FRONT SUSPENSION

ESTIMATED LIFT: 40mm

PART NO.	QTY	DESCRIPTION	RRP inc GST	NOTES
SHOCK ABSORBERS				
FC404926	2	40mm Foam Cell Strut		
BM404926	2	40mm Adjustable Strut		9 Stage Adjustable
COIL SPRINGS				
TDC270	2	40mm Lift Spring		Petrol/Diesel/Up to Alloy Bar
TDC974	2	40mm Lift Spring		Petrol/Diesel/Bar
TDC974H	2	40mm Lift Spring		Petrol/Diesel/Bar/Winch
COMPLETE STRUT ASSEMBLY				
LDV-001	2	BM404926/TDC270		Petrol/Diesel/Up to Alloy Bar
LDV-002	2	BM404926/TDC974		Petrol/Diesel/Steel Bar
LDV-003	2	BM404926/TDC974H		Petrol/Diesel/Bar/Winch
LDV-004	2	FC404926/TDC270		Petrol/Diesel/Up to Alloy Bar
LDV-005	2	FC404926/TDC974		Petrol/Diesel/Steel Bar
LDV-006	2	FC404926/TDC974H		Petrol/Diesel/Bar/Winch
REPLACEMENT STRUT TOP				
TOY-1081	2	Strut Top		Replacement Strut Top

REAR SUSPENSION

SHOCK ABSORBERS				
FC43032	2	40mm Foam Cell Shock		Suits Up to 40mm Lift
BM403032	2	40mm 9 Stage Adjustable		Suits Up to 40mm Lift
LEAF SPRINGS				
FS214C	2	0-300kg Load		40mm Lift
FS214L	2	CONSTANT 300Kg Load		40mm Lift
FS214LL	2	CONSTANT 500Kg Load		40mm Lift
COMPONENTS				
TDUK-071	1	Urethane Shackle Bushing Kit		
TDUB-016	2	U-Bolt Kit		
TDGS-391	1	Greasable Shackle Kit		Must be fitted with all kits
TDGP-668	1	Greasable Pin Kit		Must be fitted with all kits
TDSP-020	1	Centre Bearing Spacer Kit		Must be fitted with all kits
TDSP-019	1	Headlight Leveling Relocator		Must be fitted with all kits

ALL REQUIRED COMPONENTS MUST BE FITTED





Tough Dog Leaf springs and urethane bushes are not compatible with OEM shackles and pins. Always ensure that all mandatory components noted above are fitted to the vehicle.

REPLACEMENT BUSHES (QUANTITY PER SHOCK)

TOY-1081	1	Replacement Strut Top		Available As Complete Unit Only
ADJ300/40A	1	Suits Bottom Front Eye		Eyering Bonded Bushing

Fitting sheet (located page 208) must be completed when suspension fitted. Failure to comply may affect warranty.

COMPLETE KIT PRICE REFERENCE

SHOCK CHOICE	SPRING CHOICE	RRP inc GST	CONTENTS
<p>Foam Cell Struts Require Assembly</p> <p>Includes</p> <ul style="list-style-type: none"> 2x Front Struts 2x Rear Shocks 2x Front Coils 2x Leaf Springs 1x Urethane Kit 2x U-Bolt Kits 1x Centre Bearing Kit 1 x Headlight Levelling Kit 1 x Greasable Pin & Shackles 	<p>FS214C 0-300KG</p> <p>FS214L CONSTANT 300KG</p> <p>FS214LL CONSTANT 500KG</p>		
<p>Foam Cell Complete Assembly Struts</p> <p>Includes</p> <ul style="list-style-type: none"> 2x Front Strut Assy 2x Rear Shocks 2x Front Coils 2x Leaf Springs 1x Urethane Kit 2x U-Bolt Kits 1x Centre Bearing Kit 1 x Headlight Levelling Kit 1 x Greasable Pin & Shackles 	<p>FS214C 0-300KG</p> <p>FS214L CONSTANT 300KG</p> <p>FS214LL CONSTANT 500KG</p>		
<p>40mm Adjustable Struts Require Assembly</p> <p>Includes</p> <ul style="list-style-type: none"> 2x Front Struts 2x Rear Shocks 2x Front Coils 2x Leaf Springs 1x Urethane Kit 2x U-Bolt Kits 1x Centre Bearing Kit 1 x Headlight Levelling Kit 1 x Greasable Pin & Shackles 	<p>FS214C 0-300KG</p> <p>FS214L CONSTANT 300KG</p> <p>FS214LL CONSTANT 500KG</p>		
<p>40mm Adjustable Complete Assembly Struts</p> <p>Includes</p> <ul style="list-style-type: none"> 2x Front Strut Assy 2x Rear Shocks 2x Front Coils 2x Leaf Springs 1x Urethane Kit 2x U-Bolt Kits 1x Centre Bearing Kit 1 x Headlight Levelling Kit 1 x Greasable Pin & Shackles 	<p>FS214C 0-300KG</p> <p>FS214L CONSTANT 300KG</p> <p>FS214LL CONSTANT 500KG</p>		

All prices exclude freight. Include only permanent accessories & weights when selecting springs. Towing weight is not included

MAZDA

B2500, B2600, B4000

86-06

PC, PD, PE, PG, PH



ESTIMATED LIFT: 40mm

PART NO.	QTY	DESCRIPTION	RRP inc GST	NOTES
SHOCK ABSORBERS				
FC42051B	2	41mm Foam Cell Shock		Suits up to 40mm Lift
TDSK-020	1	Shock Mount Strengthening Kit		Top Pin Mount Bracket
Please Note: - Failure to fit TDSK-020 will cause top mount failure. Fitting instructions at toughdog.com.au				
TORSION BARS				
4WTB-1546	1	Replacement Torsion Bars		26mm/926mm
Adjust Torsion bars after fitting shocks - Ensure a minimum of 60mm Droop is Maintained				

REAR SUSPENSION

SHOCK ABSORBERS				
BD1232T	2	35mm Nitrogen Gas Shock		Suits Up to 40mm Lift
FC41232	2	41mm Foam Cell Shock		Suits Up to 40mm Lift
BM401232	2	40mm 9 Stage Adjustable		Suits Up to 40mm Lift
LEAF SPRINGS				
FS365	2	0-300kg Load		40mm Lift
FS367	2	CONSTANT 300Kg Load		40mm Lift
COMPONENTS				
TDUK-034	1	Urethane Shackle Bushing Kit		
TDUB-005	2	U-Bolt Kit		
REPLACEMENT BUSHINGS - QUANTITY PER SHOCK				
TW959 + TW961	1 (ea)	Suits Top Front Pin		Pin Style Bushing
4W-SPF420-05	1	Suits Bottom Front Eye		Suits Body # 42057 ONLY
4W-SPF420-02	1	Suits Bottom Front Eye		Suits Body # 42051 ONLY
ADJ00191	1	Suits Top Rear Eying		Suit Foam Cell Shocks
4W-SPF420-02	1	Suits Bottom Rear Eying		
230100	1	Suits Top Rear Eying		
230002	1	Suits Bottom Rear Eying		Suit 40mm Adjustable Shocks

COMPLETE KIT PRICE REFERENCE

SHOCK CHOICE	SPRING CHOICE	RRP inc GST	CONTENTS
Foam Cell Front Nitro gas Rear	0-300KG Constant 300kg		
41mm Foam Cell	0-300KG Constant 300kg		
Foam Cell Front Adjustable Rear	0-300KG Constant 300kg		
Includes 2 x Leaf Springs 4 x Shocks 1 x Urethane Kits 2 x U-Bolt Kits 1 x Shock Strengthening Kit			

Fitting sheet (located page 208) must be completed when suspension fitted. Failure to comply may affect warranty.



MAZDA

BT-50

11/06-10/11
B2500, B3000

FRONT SUSPENSION

ESTIMATED LIFT: 45 mm

PART NO.	QTY	DESCRIPTION	RRP inc GST	NOTES
SHOCK ABSORBERS				
FC42051B	2	41mm Foam Cell Shock		Suits up to 40mm Lift
TDSK-020	1	Shock Mount Strengthening Kit		Top Pin Mount Bracket
Please Note: - Failure to fit TDSK-020 will cause top mount failure. Fitting instructions at toughdog.com.au				
TORSION BARS				
4WTB-1440	1	Replacement Torsion Bars		27mm/1028mm
Adjust Torsion bars after fitting shocks - Ensure a minimum of 60mm Droop is Maintained				

REAR SUSPENSION

SHOCK ABSORBERS				
BD1232T	2	35mm Nitrogen Gas Shock		Suits Up to 45mm Lift
FC41232	2	41mm Foam Cell Shock		Suits Up to 45mm Lift
BM401232	2	40mm 9 Stage Adjustable		Suits Up to 45mm Lift
LEAF SPRINGS				
FS368C	2	0-300kg Load		45mm Lift
FS368L	2	CONSTANT 300Kg Load		45mm Lift
COMPONENTS				
TDUK-069	1	Urethane Shackle Bushing Kit		
TDUB-040	2	U-Bolt Kit		Suits FS368C only
TDUB-039	2	U-Bolt Kit		Suits FS368L only
TDGS-386/1	1	Greasable Shackle Kit		
TDGP-668	1	Greasable Pin Kit		
AIR ASSIST BAGS				
TDAA-101	1	Bellows bag kit		Suits 45mm Lift
TDAA-117	1	Bellows bag kit		Suits standard height ONLY

Replacement bushes listed on p 70

COMPLETE KIT PRICE REFERENCE

SHOCK CHOICE	SPRING CHOICE	RRP inc GST	CONTENTS
Foam Cell Front Nitro gas Rear	0-300KG		<p>Includes 2 x Leaf Springs 4 x Shocks 1 x Urethane Kit 2 x U-Bolt Kits 1 x Shock Mount Kit</p>
41mm Foam Cell	0-300KG		
	Constant 300kg		
Foam Cell Front Adjustable Rear	0-300KG		
	Constant 300kg		

All prices exclude freight. Include only permanent accessories & weights when selecting springs. Towing weight is not included

P: (02) 9672 8899 | F: (02) 9672 8099



MAZDA

BT-50
11/11 On
UP, UR



FRONT SUSPENSION

ESTIMATED LIFT: 40mm

PART NO.	QTY	DESCRIPTION	RRP inc GST	NOTES
SHOCK ABSORBERS				
FC404500	2	40mm Foam Cell Strut		
BM404500	2	40mm Adjustable Strut		9 Stage Adjustable
COIL SPRINGS				
TDC451	2	40mm Lift Spring		Petrol/Diesel/Bar
TDC451HL	2	40mm Lift Spring		Petrol/Diesel/Bar/Winch
COMPLETE STRUT ASSEMBLY				
MAZ-001	2	BM404500/TDC451		Petrol/Diesel/Bar
MAZ-002	2	BM404500/TDC451HL		Petrol/Diesel/Bar/Winch
MAZ-003	2	FC404500/TDC451		Petrol/Diesel/Bar
MAZ-004	2	FC404500/TDC451HL		Petrol/Diesel/Bar/Winch
ADDITIONAL COMPONENTS				
MAZ-4051	2	Strut Top		Replacement Strut Top
TDCA-003	1	Upper Control Arms (pair)		Suits up to 75mm lift

REAR SUSPENSION

SHOCK ABSORBERS				
BD1232T	2	35mm Nitrogen Gas Shock		Up to 40mm Lift (Comfort Use)
FC41232	2	41mm Foam Cell Shock		Suits Up to 40mm Lift
BM401232	2	40mm 9 Stage Adjustable		Suits Up to 40mm Lift
LEAF SPRINGS				
FS369C	2	0-300kg Load		40mm Lift
FS369L	2	CONSTANT 300Kg Load		40mm Lift
FS369LL	2	CONSTANT 500Kg Load		40mm Lift
COMPONENTS				
TDUK-070	1	Urethane Shackle Bushing Kit		
TDUB-039	2	U-Bolt Kit		Suits FS369L & LL Spring
TDUB-040	2	U-Bolt Kit		Suits FS369C Spring Only
TDGS-390	1	Greasable Shackle Kit		
TDGP-668	1	Greasable Pin Kit		
TDSP-007	1	Transmission Spacer Kit		Must Be fitted to All Lift Kits
AIR ASSIST BAGS				
TDAA-102	1	Bellows bag kit		Suits 40mm Lift
TDAA-116	1	Bellows bag kit		Suits standard height ONLY
REPLACEMENT BUSHES (QUANTITY PER SHOCK)				
MAZ-4051	1	Replacement Strut Top		Available As Complete Unit Only
ADJ00305	1	Suits Bottom Front Eye		Eyering Bonded Bushing
ADJ00191	1	Suits Top Rear Eyering		Suit Foam Cell Shocks
4W-SPF420-02	1	Suits Bottom Rear Eyering		
230100	1	Suits Top Rear BM401232		Suit 40mm Adjustable Shocks
230002	1	Suits Bottom Rear BM401232		





Fitting sheet (located page 208) must be completed when suspension fitted. Failure to comply may affect warranty.

Note: Transmission spacer fitting instructions available at toughdog.com.au

MAZDA

BT-50
11/11 On
UP, UR

COMPLETE KIT PRICE REFERENCE

SHOCK CHOICE	SPRING CHOICE	RRP inc GST	CONTENTS
Foam Cell Struts Require Assembly Includes 2x Front Struts 2x Rear Shocks 2x Front Coils 2x Leaf Springs 1x Urethane Kit 2x U-Bolt Kits 1x Transmission Spacer	FS369C (Foam Front Gas Rear)		
	FS369C (Foam Cell All) FS369L CONSTANT 300KG FC369LL CONSTANT 500KG		
Foam Cell Complete Assembly Struts Includes 2x Front Strut Assy 2x Rear Shocks 2x Leaf Springs 1x Urethane Kit 2x U-Bolt Kits 1x Transmission Space	FS369C (Foam Front Gas Rear)		
	FS369C (Foam Cell All) FS369L CONSTANT 300KG FS369LL CONSTANT 500KG		
40mm Adjustable Struts Require Assembly Includes 2x Front Struts 2x Rear Shocks 2x Front Coils 2x Leaf Springs 1x Urethane Kit 2x U-Bolt Kits 1x Transmission Spacer	FS369C 0-300KG		
	FS369L CONSTANT 300KG FS369LL CONSTANT 500KG		
40mm Adjustable Complete Assembly Struts Includes 2x Front Strut Assy 2x Rear Shocks 2x Leaf Springs 1x Urethane Kit 2x U-Bolt Kits 1x Transmission Spacer	FS369C 0-300KG		
	FS369L CONSTANT 300KG FS369LL CONSTANT 500KG		

All prices exclude freight. Include only permanent accessories & weights when selecting springs. Towing weight is not included

P: (02) 9672 8899 | F: (02) 9672 8099



MERCEDES-BENZ

X-CLASS UTE

12/17 On

X22D/X250D/X350D

FRONT SUSPENSION

ESTIMATED LIFT: 35mm

PART NO.	QTY	DESCRIPTION	RRP inc GST	NOTES
SHOCK ABSORBERS				
FC404925	2	40mm Foam Cell Strut		
BM404925	2	40mm Adjustable Strut		9 Stage Adjustable
COIL SPRINGS				
TDC1008	2	35mm Lift Spring		Suits vehicles with no accessories
TDC1009	2	35mm Lift Spring		Suits with Bar or Bar+Winch
COMPLETE STRUT ASSEMBLY				
MEC-001	2	BM404925/TDC1008		Diesel with no accessories
MEC-002	2	BM404925/TDC1009		Diesel Bar or Bar+Winch
MEC-003	2	FC404925/TDC1008		Diesel with no accessories
MEC-004	2	FC404925/TDC1009		Diesel Bar or Bar+Winch
REPLACEMENT STRUT TOP				
NIS-3030	2	Strut Top		Replacement Strut Top

REAR SUSPENSION

SHOCK ABSORBERS				
FC41369	2	41mm Foam Cell Shock		Up to 35mm Lift
BM401369	2	40mm 9 Stage Adjustable		Up to 35mm Lift
COIL SPRINGS				
TDC774	2	0-300kg Load		35mm Lift
TDC774H	2	CONSTANT 300Kg Load		35mm Lift
TDC774VHL	2	CONSTANT 500Kg Load		35mm Lift
COMPONENTS				
TDPR-300	1	Adjustable Panhard Rod		
AIR ASSIST BAGS				
TDAA-007	1	Coil insert bag kit		Suits 35mm Lift
TDAA-016	1	Coil Insert bag Kit		Suits OE Height

REPLACEMENT BUSHINGS

QUANTITY PER SHOCK				
NIS-3030	1	Replacement Strut Top		Available As Complete Unit Only
ADJ300/40	1	Suits Bottom Front Eying		Eying Bonded Bushing
404702	1	Suits Rear Top Eying		Eying Bushing
TW040/14	1	Suits Rear Bottom Eying		Eying Bushing

Fitting sheet (located page 208) must be completed when suspension fitted. Failure to comply may affect warranty.

MERCEDES-BENZ

X-CLASS UTE

12/17 On

X220D/X250D/X350D

COMPLETE KIT PRICE REFERENCE

SHOCK CHOICE	SPRING CHOICE	RRP inc GST	CONTENTS
<p>Foam Cell Struts Require Assembly</p> <p>Includes 2x Front Struts 2x Rear Shocks 2x Front Coils 2x Rear Coils</p>	<p>TDC 0-300KG Spring</p> <p>TDC CONSTANT 300KG Spring</p> <p>TDC CONSTANT 500KG Spring</p>		
<p>Foam Cell Complete Assembly Struts</p> <p>Includes 2x Front Strut Assembly 2x Rear Shocks 2x Rear Coils</p>	<p>TDC 0-300KG Spring</p> <p>TDC CONSTANT 300KG Spring</p> <p>TDC CONSTANT 500KG Spring</p>		
<p>40mm Adjustable Struts Require Assembly</p> <p>Includes 2x Front Struts 2x Rear Shocks 2x Front Coils 2x Rear Coils</p>	<p>TDC 0-300KG Spring</p> <p>TDC CONSTANT 300KG Spring</p> <p>TDC CONSTANT 500KG Spring</p>		
<p>40mm Adjustable Complete Assembly Struts</p> <p>Includes 2x Front Strut Assembly 2x Rear Shocks 2x Rear Coils</p>	<p>TDC 0-300KG Spring</p> <p>TDC CONSTANT 300KG Spring</p> <p>TDC CONSTANT 500KG Spring</p>		

All prices exclude freight. Include only permanent accessories & weights when selecting springs. Towing weight is not included

P: (02) 9672 8899 | F: (02) 9672 8099



MITSUBISHI

CHALLENGER

3/98-00

PA - LEAF REAR



FRONT SUSPENSION

ESTIMATED LIFT: 35mm

PART NO.	QTY	DESCRIPTION	RRP inc GST	NOTES
SHOCK ABSORBERS				
FC42057B	2	41mm Foam Cell Shock		Suits up to 35mm Lift
TORSION BARS				
4WTB-0203	1	Replacement Torsion Bars	r	27.5mm/1307mm
Adjust Torsion bars after fitting shocks - Ensure a minimum of 60mm Droop is Maintained				

REAR SUSPENSION

SHOCK ABSORBERS				
BD1382T	2	35mm Nitrogen Gas Shock		Suits Up to 35mm Lift
FC41382	2	41mm Foam Cell Shock		Suits Up to 35mm Lift
BM401382	2	40mm 9 Stage Adjustable		Suits Up to 35mm Lift
LEAF SPRINGS				
FS021	2	0-300kg Load		35mm Lift
COMPONENTS				
TDSK-023	1	Anti inversion bracket kit		Must be fitted with all leaf springs
TDUK-066/31	1	Urethane Shackle Bushing Kit		
TDUB-006	2	U-Bolt Kit		

REPLACEMENT BUSHINGS

QUANTITY PER SHOCK				
TW959	2	Suits Top Front Pin		Pin Style Bushing
412772	1	Suits Bottom Front Eye		Eyering Bonded Bushing
404702	2	Suits Top & Bottom Rear Eyering		Eyering Bushing

COMPLETE KIT PRICE REFERENCE

SHOCK CHOICE	SPRING CHOICE	RRP inc GST	CONTENTS
Foam Cell Front Nitro gas Rear	0-300KG		
41mm Foam Cell	0-300KG		
Foam Cell Front Adjustable Rear	0-300KG		
Includes 2 x Leaf Springs 4 x Shocks 1 x Urethane Kit 2 x U-Bolt Kits 1 x Anti Inversion Kit			

Fitting sheet (located page 208) must be completed when suspension fitted. Failure to comply may affect warranty.



MITSUBISHI CHALLENGER

6/00-07
PA II - COIL REAR

FRONT SUSPENSION

ESTIMATED LIFT: 35 mm

PART NO.	QTY	DESCRIPTION	RRP inc GST	NOTES
SHOCK ABSORBERS				
FC42057B	2	41mm Foam Cell Shock		Suits up to 35mm Lift
TORSION BARS				
4WTB-0203	1	Replacement Torsion Bars		27.5mm/1307mm
Adjust Torsion bars after fitting shocks - Ensure a minimum of 60mm Droop is Maintained				

REAR SUSPENSION

SHOCK ABSORBERS				
FC41439	2	41mm Foam Cell Shock		Suits Up to 35mm Lift
BM401439	2	40mm 9 Stage Adjustable		Suits Up to 35mm Lift
COIL SPRINGS				
TDC640	2	0-300kg Load		35mm Lift
TDC632SL	2	CONSTANT 300Kg Load		35mm Lift

REPLACEMENT BUSHINGS

QUANTITY PER SHOCK				
TW959	2	Suits Top Front Pin		Pin Style Bushing
412772	1	Suits Bottom Front Eye		Eyering Bonded Bushing
404702	1	Suits Top Rear Eyering		Eyering Bushing
TW038/16	1	Suits Bottom Rear Eye		

COMPLETE KIT PRICE REFERENCE

SHOCK CHOICE	SPRING CHOICE	RRP inc GST	CONTENTS
41mm Foam Cell	0-300KG		
Foam Cell Front Adjustable Rear	0-300KG		
Includes 2 x Coil Springs 4 x Shocks			

All prices exclude freight. Include only permanent accessories & weights when selecting springs. Towing weight is not included

P: (02) 9672 8899 | F: (02) 9672 8099



MITSUBISHI

CHALLENGER/PAJERO SPORT

09-2015
PB & PC



FRONT SUSPENSION

ESTIMATED LIFT: 25mm

PART NO.	QTY	DESCRIPTION	RRP inc GST	NOTES
SHOCK ABSORBERS				
FC404800	2	40mm Foam Cell Strut		
BM404800	2	40mm Adjustable Strut		9 Stage Adjustable
COIL SPRINGS				
TDC670	2	25mm Lift Spring		Petrol/Diesel/Bar
TDC670H	2	25mm Lift Spring		Petrol/Diesel/Bar/Winch
COMPLETE STRUT ASSEMBLY				
MIT-060/01	2	BM404800/TDC670		Petrol/Diesel/Bar
MIT-060/02	2	BM404800/TDC670H		Petrol/Diesel/Bar/Winch
MIT-060/03	2	FC404800/TDC670		Petrol/Diesel/Bar
MIT-060/04	2	FC404800/TDC670H		Petrol/Diesel/Bar/Winch
REPLACEMENT STRUT TOP				
MIT-4040	2	Strut Top		Replacement Strut Top

REAR SUSPENSION

SHOCK ABSORBERS				
FC41440B	2	41mm Foam Cell Shock		Suits Up to 25mm Lift
BM401440	2	40mm 9 Stage Adjustable		Suits Up to 25mm Lift
COIL SPRINGS				
TDC636L	2	0-300kg Load		25mm Lift
TDC636HL	2	CONSTANT 300Kg Load		25mm Lift
Use of CONSTANT load spring without load will result in tailshaft vibrations.				

REPLACEMENT BUSHINGS

QUANTITY PER SHOCK				
MIT-4040	1	Replacement Strut Top		Available As Complete Unit Only
ADJ300/50	1	Suits Bottom Front Eye		Eyering Bonded Bushing
404702	1	Suits Top Rear Eyering		Eyering Bushing
TW038/16	1	Suits Bottom Rear Eye		Eyering Bushing





Fitting sheet (located page 208) must be completed when suspension fitted. Failure to comply may affect warranty.

MITSUBISHI

PB CHALLENGER/PAJERO SPORT

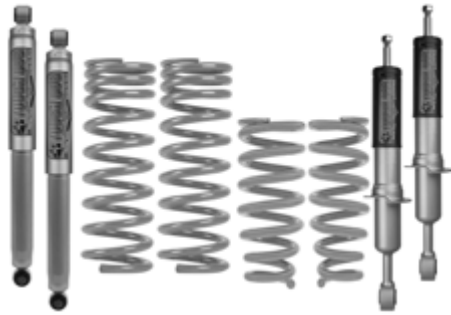
09-2015
PB & PC

COMPLETE KIT PRICE REFERENCE

SHOCK CHOICE	SPRING CHOICE	RRP inc GST	CONTENTS
<p style="text-align: center;">Foam Cell Struts Require Assembly</p> <p style="text-align: center;">Includes 2x Front Struts 2x Rear Shocks 4x Coil Springs</p>	ANY		
<p style="text-align: center;">Foam Cell Complete Assembly Struts</p> <p style="text-align: center;">Includes 2x Front Strut Assy 2x Rear Shocks 2x Rear Coils</p>	ANY		
<p style="text-align: center;">40mm Adjustable Struts Require Assembly</p> <p style="text-align: center;">Includes 2x Front Struts 2x Rear Shocks 4x Coil Springs</p>	ANY		
<p style="text-align: center;">40mm Adjustable Complete Assembly Struts</p> <p style="text-align: center;">Includes 2x Front Strut Assy 2x Rear Shocks 2x Rear Coils</p>	ANY		

All prices exclude freight. Include only permanent accessories & weights when selecting springs. Towing weight is not included

mitsubishi

L200 4WD

5/79-86

MA, MB, MC, MD

FRONT SUSPENSION

ESTIMATED LIFT: 40mm

PART NO.	QTY	DESCRIPTION	RRP inc GST	NOTES
TORSION BARS				
4WTB-1726	1	Replacement Torsion Bars		26mm/1277.5mm
Adjust Torsion bars after fitting shocks - Ensure a minimum of 60mm Droop is Maintained				

REAR SUSPENSION

SHOCK ABSORBERS				
BD1382T	2	35mm Nitrogen Gas Shock		Suits OE Height
FC41382	2	41mm Foam Cell Shock		
BM401382	2	40mm 9 Stage Adjustable		
BD1388T	2	35mm Nitrogen Gas Shock		Suits 40mm Lift
FC41388	2	41mm Foam Cell Shock		
BM401388	2	40mm 9 Stage Adjustable		
COMPONENTS				
TDUK-021/35	1	Urethane Shackle Bushing Kit		
TDUB-006	2	U-Bolt Kit		

REPLACEMENT BUSHINGS

QUANTITY PER SHOCK				
404702	2	Suits Top & Bottom Rear Eying		Eying Bushing

Fitting sheet (located page 208) must be completed when suspension fitted. Failure to comply may affect warranty.



mitsubishi

L300 4WD

4/83-94

SC, SD, SE, SF, SG, SH

FRONT SUSPENSION

ESTIMATED LIFT: 40 mm

PART NO.	QTY	DESCRIPTION	RRP inc GST	NOTES
SHOCK ABSORBERS				
BD2058T	2	35mm Nitro Gas Shock		
FC42058B	2	41mm Foam Cell Shock		Suits up to 40mm Lift
TORSION BARS				
4WTB-1726	1	Replacement Torsion Bars		26mm/1277.5mm - SC, SD, SE
Adjust Torsion bars after fitting shocks - Ensure a minimum of 60mm Droop is Maintained				

REAR SUSPENSION

SHOCK ABSORBERS				
BD1366T	2	35mm Nitro Gas Shock		Suits OE Height SC, SD, SE (5/83-86) ONLY
FC41366	2	41mm Foam Cell Shock		
BM401366	2	40mm 9 Stage Adjustable		
BD1382T	2	35mm Nitro Gas Shock		Suits 40mm Lift SC, SD, SE (5/83-86) ONLY
FC41382	2	41mm Foam Cell Shock		
BM401382	2	40mm 9 Stage Adjustable		
BD1386T	2	35mm Nitro Gas Shock		Suits OE Height SF, SG, SH (10/86-94) ONLY
FC41386	2	41mm Foam Cell Shock		
BM401386	2	40mm 9 Stage Adjustable		
BD1400T	2	35mm Nitro Gas Shock		Suits 40mm Lift SF, SG, SH (10/86-94) ONLY
FC41400	2	41mm Foam Cell Shock		
BM401400	2	40mm 9 Stage Adjustable		
COMPONENTS				
TDUK-005	1	Urethane Shackle Bushing Kit		35mm Lift
TDUB-006	2	U-Bolt Kit		35mm Lift

REPLACEMENT BUSHINGS

QUANTITY PER SHOCK				
TW959	2	Suits Top Front Pin		Pin Style Mount
404702	2	Suits Top & Bottom Rear Eying		Eying Bushing (#1366 & #1382)
404702	1	Suits Top & Bottom Rear Eying		Eying Bushing (#1386 & #1400)
TW959	2	Suits Bottom Rear Pin		Pin Style Mount (#1386 & #1400)
412772	1	Suits Bottom Front Eying		Eying Bushing (#42057B)

All prices exclude freight. Include only permanent accessories & weights when selecting springs. Towing weight is not included

P: (02) 9672 8899 | F: (02) 9672 8099



MITSUBISHI

PAJERO / MONTERO

7/83-91 (NA-NG) & 5/91-6/93 (NH)

LEAF REAR



FRONT SUSPENSION

ESTIMATED LIFT: 40mm

PART NO.	QTY	DESCRIPTION	RRP inc GST	NOTES
SHOCK ABSORBERS				
FC42058B	2	41mm Foam Cell Shock (bar pin)		40mm Lift (7/83-91 ONLY)
FC42057B	2	41mm Foam Cell Shock (sleeve)		40mm Lift (5/91-96 ONLY)
TORSION BARS				
4WTB-1726	1	Replacement Torsion Bars		26mm/1277.5mm
Adjust Torsion bars after fitting shocks - Ensure a minimum of 60mm Droop is Maintained				
STEERING DAMPERS				
SS5013-P/S	1	Return to Centre Damper		Damper Mounts Present in Vehicle
SS5016-P/S	1	Return to Centre Damper		Mounts Not Present in Vehicle

REAR SUSPENSION

SHOCK ABSORBERS				
FC41382	2	41mm Foam Cell Shock		Suits Up to 40mm Lift
BM401382	2	40mm 9 Stage Adjustable		Suits Up to 40mm Lift
LEAF SPRINGS				
FS021	2	0-300kg Load		40mm Lift
FS021H	2	CONSTANT 300Kg Load		40mm Lift
COMPONENTS				
TDUK-005	1	Urethane Shackle Bushing Kit		
TDUB-006	2	U-Bolt Kit		
TDGP-004	1	Greasable Pin Kit		
TDGS-900	1	Greasable Shackle Kit		

REPLACEMENT BUSHINGS

QUANTITY PER SHOCK				
TW959	2	Suits Top Front Pin		Pin Style Bushing
404702	2	Suits Top & Bottom Rear Eying		Eying Bushing
412772	1	Suits Bottom Front Eying		Eying Bushing (#2057B ONLY)

COMPLETE KIT PRICE REFERENCE

SHOCK CHOICE	SPRING CHOICE	RRP inc GST	CONTENTS
41mm Foam Cell	0-300KG		
	CONSTANT 300KG		
Foam Cell Front Adjustable Rear	0-300KG		
	CONSTANT 300KG		
Includes 2 x Leaf Springs 4 x Shocks 1 x Urethane Kits 2 x U-Bolt Kits			

Fitting sheet (located page 208) must be completed when suspension fitted. Failure to comply may affect warranty.



MITSUBISHI

PAJERO / MONTERO

8/88-91 (NF-NG) & 5/91-00 (NH-NL)

COIL REAR

FRONT SUSPENSION

ESTIMATED LIFT: 40 mm

PART NO.	QTY	DESCRIPTION	RRP inc GST	NOTES
SHOCK ABSORBERS				
FC42058B	2	41mm Foam Cell Shock		40mm Lift (7/88-91 ONLY)
FC42057B	2	41mm Foam Cell Shock		40mm Lift (5/91-00 ONLY)
TORSION BARS				
4WTB-1726	1	Replacement Torsion Bars		26mm/1277.5mm (91-5/96)
4WTB-0203	1	Replacement Torsion Bars		27.5mm/1307mm (6/96-00)
Check bars first! - Adjust torsion bars after fitting shocks - Ensure a minimum of 60mm Droop is Maintained				
STEERING DAMPERS				
SS5013-P/S	1	Return to Centre Damper		Damper Mounts Present in Vehicle
SS5016-P/S	1	Return to Centre Damper		Mounts Not Present in Vehicle

REAR SUSPENSION

SHOCK ABSORBERS				
FC41439	2	41mm Foam Cell Shock		Up to 40mm Lift (7/88-91 ONLY)
BM401439	2	40mm 9 Stage Adjustable		Up to 40mm Lift (7/88-91 ONLY)
FC41170B	2	41mm Foam Cell Shock		Suits OE Height (5/91-00 ONLY)
BM401170	2	40mm 9 Stage Adjustable		Suits OE Height (5/91-00 ONLY)
FC41178B	2	41mm Foam Cell Shock		Up to 40mm Lift (5/91-00 ONLY)
BM401178	2	40mm 9 Stage Adjustable		Up to 40mm Lift (5/91-00 ONLY)
COIL SPRINGS				
TDC632SL	2	0-300kg Load		40mm Lift
TDC632L	2	CONSTANT 300Kg Load		40mm Lift

REPLACEMENT BUSHINGS

QUANTITY PER SHOCK				
TW959	2	Suits Top Front Pin		Pin Style Bushing
412772	1	Suits Bottom Front Eye		Eyering Bushing (#2057B)
402267	2	Suits Top Pin Mount Rear		Eyering Bushing (#1170 & 78)

COMPLETE KIT PRICE REFERENCE

SHOCK CHOICE	SPRING CHOICE	RRP inc GST	CONTENTS
41mm Foam Cell	0-300KG		
Foam Cell Front Adjustable Rear	0-300KG		
Includes 2 x Coil Springs 4 x Shocks			

All prices exclude freight. Include only permanent accessories & weights when selecting springs. Towing weight is not included

P: (02) 9672 8899 | F: (02) 9672 8099



MITSUBISHI

PAJERO / MONTERO

5/00 on - LONG WHEEL BASE
NM, NP, NS, NT, NW, NX (LWB)



FRONT SUSPENSION

ESTIMATED LIFT: 40mm

PART NO.	QTY	DESCRIPTION	RRP inc GST	NOTES
SHOCK ABSORBERS				
FC404300	2	40mm Foam Cell Strut		
BM404300	2	40mm Adjustable Strut		9 Stage Adjustable
COIL SPRINGS				
TDC631	2	OE Height Spring		
TDC633	2	40mm Lift Spring		Petrol/Bar
TDC633L	2	40mm Lift Spring		Diesel/Bar
TDC633H	2	40mm Lift Spring		Petrol/Diesel/Bar/Winch
COMPLETE STRUT ASSEMBLY				
MIT-050/01	2	BM404300/TDC633		Petrol/Bar
MIT-050/02	2	BM404300/TDC633L		Diesel/Bar
MIT-050/03	2	BM404300/TDC633H		Petrol/Diesel/Bar/Winch
MIT-050/04	2	FC404300/TDC633		Petrol/Bar
MIT-050/05	2	FC404300/TDC633L		Diesel/Bar
MIT-050/06	2	FC404300/TDC633H		Petrol/Diesel/Bar/Winch
REPLACEMENT STRUT TOP				
MIT-4038	2	Strut Top		Replacement Strut Top

REAR SUSPENSION

SHOCK ABSORBERS				
FC41148	2	41mm Foam Cell Shock		Suits Up to 40mm Lift
COIL SPRINGS				
TDC635S	2	0-300kg Load		OE Height
TDC635	2	CONSTANT 300Kg Load		OE Height
TDC635	2	0-300kg Load		40mm Lift
TDC635H	2	CONSTANT 300Kg Load		40mm Lift
TDC635HH	2	CONSTANT 500Kg Load		40mm Lift
AIR ASSIST BAGS				
TDAA-006	1	Coil insert bag kit		suits 40mm Lift
TDAA-012	1	Coil insert bag kit		Suits standard height ONLY

REPLACEMENT BUSHINGS

QUANTITY PER SHOCK				
MIT-4038	1	Replacement Strut Top		Available As Complete Unit Only
ADJ300/40	1	Suits Bottom Front Eye		Eyering Bonded Bushing
TW959	2	Suits Top Rear Pin Style		Pin Style Bushing
TW-038/16	1	Suits Bottom Rear Eyering		Eyering Bushing

Fitting sheet (located page 208) must be completed when suspension fitted. Failure to comply may affect warranty.





Note: Front Strut Fitting Instructions available at toughdog.com.au

MITSUBISHI

PAJERO / MONTERO

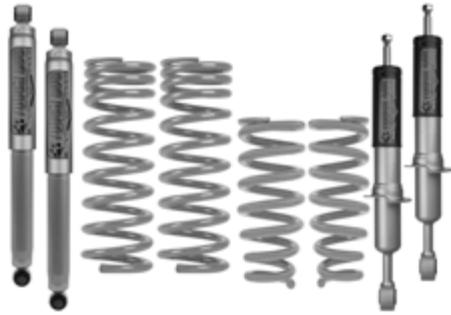
5/00 on - LONG WHEEL BASE
NM, NP, NS, NT, NW, NX (LWB)

COMPLETE KIT PRICE REFERENCE

SHOCK CHOICE	SPRING CHOICE	RRP inc GST	CONTENTS
<p>Foam Cell Struts Require Assembly</p> <p>Includes 2x Front Struts 2x Rear Shocks 4x Coil Springs</p>	ANY		
<p>Foam Cell Complete Assembly Struts</p> <p>Includes 2x Front Strut Assy 2x Rear Shocks 2x Rear Coils</p>	ANY		
<p>Adjustable Front Foam Cell Rear Struts Require Assembly</p> <p>Includes 2x Front Struts 2x Rear Shocks 4x Coil Springs</p>	ANY		
<p>Adjustable Front Foam Cell Rear Complete Assembly Struts</p> <p>Includes 2x Front Strut Assy 2x Rear Shocks 2x Rear Coils</p>	ANY		

All prices exclude freight. Include only permanent accessories & weights when selecting springs. Towing weight is not included

MITSUBISHI

PAJERO / MONTERO

5/00 on - SHORT WHEEL BASE
NM, NP, NS, NT, NW, NX (SWB)



FRONT SUSPENSION

ESTIMATED LIFT: 40mm

PART NO.	QTY	DESCRIPTION	RRP inc GST	NOTES
SHOCK ABSORBERS				
FC404300	2	40mm Foam Cell Strut		
BM404300	2	40mm Adjustable Strut		9 Stage Adjustable
COIL SPRINGS				
TDC631	2	OE Height Spring		
TDC633	2	40mm Lift Spring		Petrol/Bar
TDC633L	2	40mm Lift Spring		Diesel/Bar
TDC633H	2	40mm Lift Spring		Petrol/Diesel/Bar/Winch
COMPLETE STRUT ASSEMBLY				
MIT-050/01	2	BM404300/TDC633		Petrol/Bar
MIT-050/02	2	BM404300/TDC633L		Diesel/Bar
MIT-050/03	2	BM404300/TDC633H		Petrol/Diesel/Bar/Winch
MIT-050/04	2	FC404300/TDC633		Petrol/Bar
MIT-050/05	2	FC404300/TDC633L		Diesel/Bar
MIT-050/06	2	FC404300/TDC633H		Petrol/Diesel/Bar/Winch
REPLACEMENT STRUT TOP				
MIT-4038	2	Strut Top		Replacement Strut Top

REAR SUSPENSION

SHOCK ABSORBERS				
FC41148	2	41mm Foam Cell Shock		Suits Up to 40mm Lift
COIL SPRINGS				
TDC635S	2	0-300kg Load		40mm Lift
TDC635	2	CONSTANT 300Kg Load		40mm Lift
AIR ASSIST BAGS				
TDAA-006	1	Coil insert bag kit		Suits 40mm Lift
TDAA-012	1	Coil insert bag kit		Suits standard height ONLY

REPLACEMENT BUSHINGS

QUANTITY PER SHOCK				
MIT-4038	1	Replacement Strut Top		Available As Complete Unit Only
ADJ300/40	1	Suits Bottom Front Eye		Eyering Bonded Bushing
TW959	2	Suits Top Rear Pin Style		Pin Style Bushing
TW-038/16	1	Suits Bottom Rear Eyering		Eyering Bushing

Fitting sheet (located page 208) must be completed when suspension fitted. Failure to comply may affect warranty.





Note: Front Strut Fitting Instructions available at toughdog.com.au

MITSUBISHI

PAJERO / MONTERO

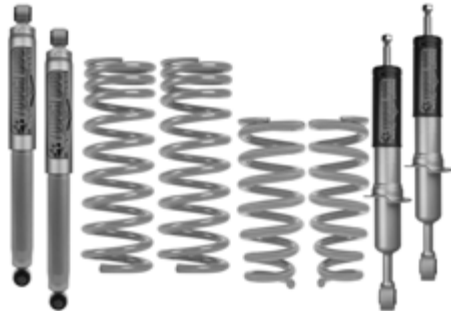
5/00 on - SHORT WHEEL BASE
NM, NP, NT, NW, NX (SWB)

COMPLETE KIT PRICE REFERENCE

SHOCK CHOICE	SPRING CHOICE	RRP inc GST	CONTENTS
<p>Foam Cell Struts Require Assembly</p> <p>Includes 2x Front Struts 2x Rear Shocks 4x Coil Springs</p>	ANY		
<p>Foam Cell Complete Assembly Struts</p> <p>Includes 2x Front Strut Assy 2x Rear Shocks 2x Rear Coils</p>	ANY		
<p>Adjustable Front Foam Cell Rear Struts Require Assembly</p> <p>Includes 2x Front Struts 2x Rear Shocks 4x Coil Springs</p>	ANY		
<p>Adjustable Front Foam Cell Rear Complete Assembly Struts</p> <p>Includes 2x Front Strut Assy 2x Rear Shocks 2x Rear Coils</p>	ANY		

All prices exclude freight. Include only permanent accessories & weights when selecting springs. Towing weight is not included

MITSUBISHI

PAJERO SPORT

2015 On
QE



FRONT SUSPENSION

ESTIMATED LIFT: 20mm

PART NO.	QTY	DESCRIPTION	RRP inc GST	NOTES
SHOCK ABSORBERS				
FC404800	2	40mm Foam Cell Strut		
BM404800	2	40mm Adjustable Strut		9 Stage Adjustable
COIL SPRINGS				
TDC681	2	20mm Lift Spring		Diesel
TDC681L	2	20mm Lift Spring		Diesel/Bar
TDC681HL	2	20mm Lift Spring		Diesel/Bar/Winch
COMPLETE STRUT ASSEMBLY				
MIT-061/01	2	BM404800/TDC681		Diesel
MIT-061/02	2	BM404800/TDC681L		Diesel/Bar
MIT-061/03	2	BM404800/TDC681HL		Diesel/Bar/Winch
MIT-061/05	2	FC404800/TDC681		Diesel
MIT-061/06	2	FC404800/TDC681L		Diesel/Bar
MIT-061/07	2	FC404800/TDC681HL		Diesel/Bar/Winch
REPLACEMENT STRUT TOP				
MIT-4040	2	Strut Top		Replacement Strut Top

REAR SUSPENSION

SHOCK ABSORBERS				
FC41440B	2	41mm Foam Cell Shock		Suits Up to 20mm Lift
BM401440	2	40mm 9 Stage Adjustable		Suits Up to 20mm Lift
COIL SPRINGS				
TDC638L	2	0-300kg Load		20mm Lift
TDC638HL	2	CONSTANT 300Kg Load		20mm Lift
Use of CONSTANT load spring without load will result in tailshaft vibrations.				
AIR ASSIST BAGS				
TDAA-001	1	Coil insert bag kit (red bag kit)		Suits 20mm Lift
TDAA-015	1	Coil insert bag kit (red bag kit)		Suits standard height ONLY

REPLACEMENT BUSHINGS

QUANTITY PER SHOCK				
MIT-4040	1	Replacement Strut Top		Available As Complete Unit Only
ADJ300/50	1	Suits Bottom Front Eye		Eyering Bonded Bushing
404702	1	Suits Top Rear Eyering		Eyering Bushing
TW038/16	1	Suits Bottom Rear Eye		Eyering Bushing





Fitting sheet (located page 208) must be completed when suspension fitted. Failure to comply may affect warranty.

MITSUBISHI

PAJERO SPORT

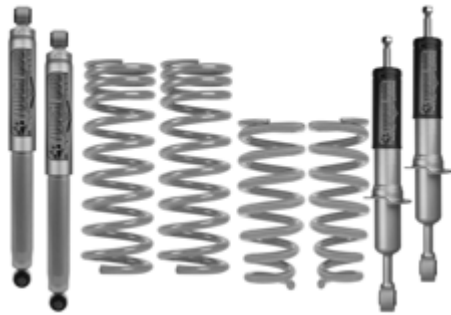
2015 on
QE

COMPLETE KIT PRICE REFERENCE

SHOCK CHOICE	SPRING CHOICE	RRP inc GST	CONTENTS
<p>Foam Cell Struts Require Assembly</p> <p><u>Includes</u> 2x Front Struts 2x Rear Shocks 4x Coil Springs</p>	ANY		
<p>Foam Cell Complete Assembly Struts</p> <p><u>Includes</u> 2x Front Strut Assy 2x Rear Shocks 2x Rear Coils</p>	ANY		
<p>40mm Adjustable Struts Require Assembly</p> <p><u>Includes</u> 2x Front Struts 2x Rear Shocks 4x Coil Springs</p>	ANY		
<p>40mm Adjustable Complete Assembly Struts</p> <p><u>Includes</u> 2x Front Strut Assy 2x Rear Shocks 2x Rear Coils</p>	ANY		

All prices exclude freight. Include only permanent accessories & weights when selecting springs. Towing weight is not included

MITSUBISHI

TRITON

10/86-06

ME, MF, MG, MH, MK



FRONT SUSPENSION

ESTIMATED LIFT: 40mm

PART NO.	QTY	DESCRIPTION	RRP inc GST	NOTES
SHOCK ABSORBERS				
BD2058T	2	35mm Nitro Gas Shock		Up to 40mm Lift (Up to MK)
BD2057T	2	35mm Nitro Gas Shock		Up to 40mm Lift (MK 10/96-06)
FC42057B	2	41mm Foam Cell Shock		Up to 40mm Lift (MK 10/96-06)
TORSION BARS				
4WTB-1726	1	Replacement Torsion Bars		26mm/1277.5mm
4WTB-1736	1	Replacement Torsion Bars		26mm/1370mm
Check bars first! - Adjust torsion bars after fitting shocks - Ensure a minimum of 60mm Droop is Maintained				

REAR SUSPENSION

SHOCK ABSORBERS				
BD1388T	2	35mm Nitro Gas Shock		Suits Up to 40mm Lift
FC41388	2	41mm Foam Cell Shock		Suits Up to 40mm Lift
BM401388	2	40mm 9 Stage Adjustable		Suits Up to 40mm Lift
LEAF SPRINGS				
FS021	2	0-300kg Load		40mm Lift
FS021H	2	CONSTANT 300Kg Load		40mm Lift
Some special edition models equipped with H/Duty leaf packs from factory - Check prior to ordering.				
COMPONENTS				
TDSK-023	1	Anti Inversion Kit		Must be fitted with all leaf springs
TDUK-021/31	1	Urethane Shackle Bushing Kit		
TDUB-006	2	U-Bolt Kit		
TDGS-900	1	Greasable Shackle Kit		

REPLACEMENT BUSHINGS

QUANTITY PER SHOCK				
TW959	2	Suits Top Front Pin		Pin Style Bushing
412772	1	Suits Bottom Front Eye		Eyering Bushing (#2057)
404702	2	Suits Top & Bottom Rear Eye		Eyering Bushing

Fitting sheet (located page 208) must be completed when suspension fitted. Failure to comply may affect warranty.



MITSUBISHI

TRITON

10/86-06

ME, MF, MG, MH, MK

COMPLETE KIT PRICE REFERENCE

SHOCK CHOICE	SPRING CHOICE	RRP inc GST	CONTENTS
<p>35mm Nitro Gas</p> <p><u>Includes</u> 2x Front Shocks 2x Rear Shocks 2x Leaf Springs 1x Urethane Kit 2x U-Bolt Kits 1 X Anti Inversion Bkts</p>	<p>0-300KG Spring</p> <p>CONSTANT 300KG Spring</p>		
<p>41mm Foam Cell</p> <p><u>Includes</u> 2x Front Shocks 2x Rear Shocks 2x Leaf Springs 1x Urethane Kit 2x U-Bolt Kits 1 X Anti Inversion Bkts</p>	<p>0-300KG Spring</p> <p>CONSTANT 300KG Spring</p>		
<p>Foam Cell Front Adjustable Rear</p> <p><u>Includes</u> 2x Front Shocks 2x Rear Shocks 2x Leaf Springs 1x Urethane Kit 2x U-Bolt Kits 1 X Anti Inversion Bkts</p>	<p>0-300KG Spring</p> <p>CONSTANT 300KG Spring</p>		

All prices exclude freight. Include only permanent accessories & weights when selecting springs. Towing weight is not included

P: (02) 9672 8899 | F: (02) 9672 8099



MITSUBISHI

TRITON

7/06-15

ML MN (To MY15)



FRONT SUSPENSION

ESTIMATED LIFT: 25mm

PART NO.	QTY	DESCRIPTION	RRP inc GST	NOTES
SHOCK ABSORBERS				
FC404800	2	40mm Foam Cell Strut		
BM404800	2	40mm Adjustable Strut		9 Stage Adjustable
COIL SPRINGS				
TDC670	2	25mm Lift Spring		Petrol/Diesel/Bar
TDC670H	2	25mm Lift Spring SEE NOTE		Petrol/Diesel/Bar/Winch
COMPLETE STRUT ASSEMBLY				
MIT-060/01	2	BM404800/TDC670		Petrol/Diesel/Bar
MIT-060/02	2	BM404800/TDC670H SEE NOTE		Petrol/Diesel/Bar/Winch
MIT-060/03	2	FC404800/TDC670		Petrol/Diesel/Bar
MIT-060/04	2	FC404800/TDC670H SEE NOTE		Petrol/Diesel/Bar/Winch
REPLACEMENT STRUT TOP				
MIT-4040	2	Strut Top		Replacement Strut Top

REAR SUSPENSION

SHOCK ABSORBERS				
BD1383T	2	35mm Nitro Gas Shocks		Suits Up to 25mm Lift
FC41383	2	41mm Foam Cell Shock		Suits Up to 25mm Lift
BM401383	2	40mm 9 Stage Adjustable		Suits Up to 25mm Lift
LEAF SPRINGS				
FS122C	2	0-300kg Load		25mm Lift
FS122L	2	CONSTANT 300Kg Load		25mm Lift
FS122LL	2	CONSTANT 500Kg Load		25mm Lift
COMPONENTS				
TDUK-021/41	1	Urethane Shackle Bushing Kit		Suits OEM Spring ONLY
TDUK-021/31	1	Urethane Shackle Bushing Kit		Suits Tough Dog Spring ONLY
TDUB-036	2	U-Bolt Kit		
TDGS-900	1	Greasable Shackle Kit		
AIR ASSIST BAGS				
TDAA-105	1	Bellows bag kit		Suits 25mm Lift

REPLACEMENT BUSHINGS

QUANTITY PER SHOCK				
MIT-4040	1	Replacement Strut Top		Available As Complete Unit Only
ADJ300/50	1	Suits Bottom Front Eying		Eying Bushing (FC and BM Pts)
404702	2	Suits Top & Bottom Rear Eying		Eying Bushing (Foam Cell)
TW038-16	1	Suits Top Rear Eying		Eying Bushing (Adjustable)
404702	1	Suits Bottom Rear Eying		Eying Bushing (Adjustable)

Fitting sheet (located page 208) must be completed when suspension fitted. Failure to comply may affect warranty.

MITSUBISHI

TRITON

7/06-15

ML MN (To MY15)

COMPLETE KIT PRICE REFERENCE

SHOCK CHOICE	SPRING CHOICE	RRP inc GST	CONTENTS
<p>Foam Cell Struts Req' Assy</p> <p><u>Includes</u> 2x Front Struts 2x Rear Shocks 2x Front Coils 2x Leaf Springs 1x Urethane Kit 2x U-Bolt Kits</p>	<p>FS122C (Foam Front Gas Rear)</p> <p>FS122C (Foam Cell All)</p> <p>FS122L CONSTANT 300KG</p> <p>FS122LL CONSTANT 500KG</p>		
<p>Foam Cell Complete Assembly Struts</p> <p><u>Includes</u> 2x Front Strut Assy 2x Rear Shocks 2x Leaf Springs 1x Urethane Kit 2x U-Bolt Kits</p>	<p>FS122C (Foam Front Gas Rear)</p> <p>FS122C (Foam Cell All)</p> <p>FS122L CONSTANT 300KG</p> <p>FS122LL CONSTANT 500KG</p>		
<p>40mm Adjustable Struts Req' Assy</p> <p><u>Includes</u> 2x Front Struts 2x Rear Shocks 2x Front Coils 2x Leaf Springs 1x Urethane Kit 2x U-Bolt Kits</p>	<p>FS122C 0-300KG</p> <p>FS122L CONSTANT 300KG</p> <p>FS122LL CONSTANT 500KG</p>		
<p>40mm Adjustable Complete Assy Struts</p> <p><u>Includes</u> 2x Front Strut Assy 2x Rear Shocks 2x Leaf Springs 1x Urethane Kit 2x U-Bolt Kits</p>	<p>FS122C 0-300KG</p> <p>FS122L CONSTANT 300KG</p> <p>FS122LL CONSTANT 500KG</p>		



NOTE - REAR OVERHANG CONSIDERATION

Due to excessive overhang created by the design of the Mitsubishi Tritons, vehicle carrying greater than 600kg load constantly in the rear should be fitted with a front spring one specification lighter than normal specification - this will guard against 'see'saw' effect at the rear of the vehicle!

Failure to observe will result in leaf spring riding at lower than desired height and potential front shock damage.

All prices exclude freight. Include only permanent accessories & weights when selecting springs. Towing weight is not included

P: (02) 9672 8899 | F: (02) 9672 8099



MITSUBISHI

TRITON

01/16 - 2018

MQ



FRONT SUSPENSION

ESTIMATED LIFT: 20mm

PART NO.	QTY	DESCRIPTION	RRP inc GST	NOTES
SHOCK ABSORBERS				
FC404800	2	40mm Foam Cell Strut		
BM404800	2	40mm Adjustable Strut		9 Stage Adjustable
COIL SPRINGS				
TDC681	2	20mm Lift Spring		Diesel
TDC681L	2	20mm Lift Spring SEE NOTE		Diesel/Bar
TDC681HL	2	20mm Lift Spring SEE NOTE		Diesel/Bar/Winch
COMPLETE STRUT ASSEMBLY				
MIT-061/01	2	BM404800/TDC681		Diesel
MIT-061/02	2	BM404800/TDC681L SEE NOTE		Diesel/Bar
MIT-061/03	2	BM404800/TDC681HL SEE NOTE		Diesel/Bar/Winch
MIT-061/05	2	FC404800/TDC681		Diesel
MIT-061/06	2	FC404800/TDC681L SEE NOTE		Diesel/Bar
MIT-061/07	2	FC404800/TDC681HL SEE NOTE		Diesel/Bar/Winch
REPLACEMENT STRUT TOP				
MIT-4040	2	Strut Top		Replacement Strut Top

REAR SUSPENSION

SHOCK ABSORBERS				
BD3012T	2	35mm Nitro Gas Shocks		Suits Up to 20mm Lift
FC43012	2	41mm Foam Cell Shock		Suits Up to 20mm Lift
BM403012	2	40mm 9 Stage Adjustable		Suits Up to 20mm Lift
LEAF SPRINGS				
FS123C	2	0-300kg Load		20mm Lift
FS123L	2	CONSTANT 300Kg Load		20mm Lift
FS123LL	2	CONSTANT 500Kg Load		20mm Lift
COMPONENTS				
TDUK-077	1	Urethane Shackle Bushing Kit		
TDUB-016	2	U-Bolt Kit		
TDGS-901	1	Greasable Shackle Kit		
TDGP-668	1	Greasable Pin Kit		
TDSP-008	1	Centre Bearing Strengthening Kit		Required with all Lift Kits
AIR ASSIST BAGS				
TDAA-106	1	Bellows bag kit		Suits 20mm Lift
TDAA-119	1	Bellows bag kit		Suits standard height ONLY
REPLACEMENT BUSHES (QUANTITY PER SHOCK)				
MIT-4040	1	Replacement Strut Top		Available As Complete Unit Only
ADJ300/50	1	Suits Bottom Front Eying		Eying Bonded Bushing
404702	1	Suits Top Rear Eying		Eying Bushing
TW038-16	1	Suits Bottom Rear Eying		Eying Bushing

Fitting sheet (located page 208) must be completed when suspension fitted. Failure to comply may affect warranty.





Note: Centre bearing strengthening kit fitting instructions available at toughdog.com.au

MITSUBISHI

TRITON

01/16 - 2018
MQ

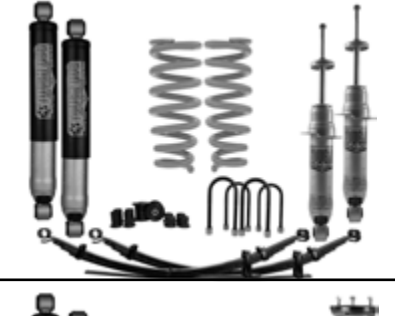
COMPLETE KIT PRICE REFERENCE

SHOCK CHOICE	SPRING CHOICE	RRP inc GST	CONTENTS
<p>Foam Cell Struts Req Assy</p> <p>Includes 2x Front Struts 2x Rear Shocks 2x Front Coils 2x Leaf Springs 1x Urethane Kit 2x U-Bolt Kits 1x Centre Bearing Kit</p>	<p>FS123C (Foam Front Gas Rear)</p> <p>FS123C (Foam Cell All)</p> <p>FS123L CONSTANT 300KG</p> <p>FS123LL CONSTANT 500KG</p>		
<p>Foam Cell Complete Assembly Struts</p> <p>Includes 2x Complete Struts 2x Rear Shocks 2x Leaf Springs 1x Urethane Kit 2x U-Bolt Kits 1x Centre Bearing Kit</p>	<p>FS123C (Foam Front Gas Rear)</p> <p>FS123C (Foam Cell All)</p> <p>FS123L CONSTANT 300KG</p> <p>FS123LL CONSTANT 500KG</p>		
<p>40mm Adjustable Struts Req Assy</p> <p>Includes 2x Front Struts 2x Rear Shocks 2x Front Coils 2x Leaf Springs 1x Urethane Kit 2x U-Bolt Kits 1x Centre Bearing Kit</p>	<p>FS123C 0-300KG</p> <p>FS123L CONSTANT 300KG</p> <p>FS123LL CONSTANT 500KG</p>		
<p>40mm Adjustable Complete Assembly Struts</p> <p>Includes 2x Complete Struts 2x Rear Shocks 2x Leaf Springs 1x Urethane Kit 2x U-Bolt Kits 1x Centre Bearing Kit</p>	<p>FS123C 0-300KG</p> <p>FS123L CONSTANT 300KG</p> <p>FS123LL CONSTANT 500KG</p>		



NOTE - REAR OVERHANG CONSIDERATION

Due to excessive overhang created by the design of the Mitsubishi Tritons, vehicle carrying greater than 600kg load constantly in the rear should be fitted with a front spring one specification lighter than normal specification - this will guard against 'see'saw' effect at the rear of the vehicle!

Failure to observe will result in leaf spring riding at lower than desired height and potential front shock damage.

All prices exclude freight. Include only permanent accessories & weights when selecting springs. Towing weight is not included

MITSUBISHI

TRITON
11/18 On
MR



FRONT SUSPENSION

ESTIMATED LIFT: 20mm

PART NO.	QTY	DESCRIPTION	RRP inc GST	NOTES
SHOCK ABSORBERS				
FC404800	2	40mm Foam Cell Strut		
BM404800	2	40mm Adjustable Strut		9 Stage Adjustable
COIL SPRINGS				
TDC1029	2	20mm Lift Spring		Diesel
TDC1030	2	20mm Lift Spring SEE NOTE		Diesel/Bar
TDC1031	2	20mm Lift Spring SEE NOTE		Diesel/Bar/Winch
COMPLETE STRUT ASSEMBLY				
MIT-001	2	BM404800/TDC1029		Diesel
MIT-002	2	BM404800/TDC1030 SEE NOTE		Diesel/Bar
MIT-003	2	BM404800/TDC1031 SEE NOTE		Diesel/Bar/Winch
MIT-004	2	FC404800/TDC1029		Diesel
MIT-005	2	FC404800/TDC1030 SEE NOTE		Diesel/Bar
MIT-006	2	FC404800/TDC1031 SEE NOTE		Diesel/Bar/Winch
REPLACEMENT STRUT TOP				
MIT-4040	2	Strut Top		Replacement Strut Top





REAR SUSPENSION

SHOCK ABSORBERS				
BD3012T	2	35mm Nitro Gas Shocks		Suits Up to 20mm Lift
FC43012	2	40mm Foam Cell Shock		Suits Up to 20mm Lift
BM403012	2	40mm 9 Stage Adjustable		Suits Up to 20mm Lift
LEAF SPRINGS				
FS123C	2	0-300kg Load		20mm Lift
FS123L	2	CONSTANT 300Kg Load		20mm Lift
FS123LL	2	CONSTANT 500Kg Load		20mm Lift
COMPONENTS				
TDUK-077	1	Urethane Shackle Bushing Kit		
TDUB-016	2	U-Bolt Kit		
TDGS-901	1	Greasable Shackle Kit		
TDGP-668	1	Greasable Pin Kit		
TDSP-008	1	Centre Bearing Strengthening Kit		Required with all Lift Kits
AIR ASSIST BAGS				
TDAA-106	1	Bellows bag kit		Suits 20mm Lift
TDAA-119	1	Bellows bag kit		Suits standard height ONLY
REPLACEMENT BUSHES (QUANTITY PER SHOCK)				
MIT-4040	1	Replacement Strut Top		Available As Complete Unit Only
ADJ300/50	1	Suits Bottom Front Eying		Eying Bonded Bushing
404702	1	Suits Top Rear Eying		Eying Bushing
TW038-16	1	Suits Bottom Rear Eying		Eying Bushing

Fitting sheet (located page 208) must be completed when suspension fitted. Failure to comply may affect warranty.

Note: Centre bearing strengthening kit fitting instructions available at toughdog.com.au

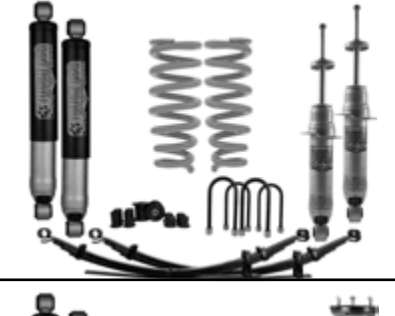
COMPLETE KIT PRICE REFERENCE

SHOCK CHOICE	SPRING CHOICE	RRP inc GST	CONTENTS
<p>Foam Cell Struts Req Assy</p> <p>Includes</p> <ul style="list-style-type: none"> 2x Front Struts 2x Rear Shocks 2x Front Coils 2x Leaf Springs 1x Urethane Kit 2x U-Bolt Kits 1x Centre Bearing Kit 	<p>FS123C (Foam Front Gas Rear)</p> <p>FS123C (Foam Cell All)</p> <p>FS123L CONSTANT 300KG</p> <p>FS123LL CONSTANT 500KG</p>		
<p>Foam Cell Complete Assembly Struts</p> <p>Includes</p> <ul style="list-style-type: none"> 2x Complete Struts 2x Rear Shocks 2x Leaf Springs 1x Urethane Kit 2x U-Bolt Kits 1x Centre Bearing Kit 	<p>FS123C (Foam Front Gas Rear)</p> <p>FS123C (Foam Cell All)</p> <p>FS123L CONSTANT 300KG</p> <p>FS123LL CONSTANT 500KG</p>		
<p>40mm Adjustable Struts Req Assy</p> <p>Includes</p> <ul style="list-style-type: none"> 2x Front Struts 2x Rear Shocks 2x Front Coils 2x Leaf Springs 1x Urethane Kit 2x U-Bolt Kits 1x Centre Bearing Kit 	<p>FS123C 0-300KG</p> <p>FS123L CONSTANT 300KG</p> <p>FS123LL CONSTANT 500KG</p>		
<p>40mm Adjustable Complete Assembly Struts</p> <p>Includes</p> <ul style="list-style-type: none"> 2x Complete Struts 2x Rear Shocks 2x Leaf Springs 1x Urethane Kit 2x U-Bolt Kits 1x Centre Bearing Kit 	<p>FS123C 0-300KG</p> <p>FS123L CONSTANT 300KG</p> <p>FS123LL CONSTANT 500KG</p>		



NOTE - REAR OVERHANG CONSIDERATION

Due to excessive overhang created by the design of the Mitsubishi Tritons, vehicle carrying greater than 600kg load constantly in the rear should be fitted with a front spring one specification lighter than normal specification - this will guard against 'see'saw' effect at the rear of the vehicle!

Failure to observe will result in leaf spring riding at lower than desired height and potential front shock damage.

All prices exclude freight. Include only permanent accessories & weights when selecting springs. Towing weight is not included

NISSAN

NAVARA

1/86-15

D21, D22



FRONT SUSPENSION

ESTIMATED LIFT: 40mm

PART NO.	QTY	DESCRIPTION	RRP inc GST	NOTES
SHOCK ABSORBERS				
FC42052B	2	35mm Foam Cell Shock		Up to 40mm Lift
TORSION BARS				
4WTB-1456	1	Replacement Torsion Bars		26mm/1203mm '1/86-97 ONLY
4WTB-1446	1	Replacement Torsion Bars		26mm/890mm '97 On ONLY
Adjust Torsion bars after fitting shocks - Ensure a minimum of 60mm Droop is Maintained				
STEERING DAMPERS				
SD14035	1	H/D Replacement Damper		Suits D21 Vehicles Only
EXT5925	1	H/D Replacement Damper		Suits D22 Vehicles Only
SS5925-P/S	1	Return to Centre Damper		Fitting instructions found at toughdog.com.au
SV5925	1	9 Stage Adjustable Damper		

REAR SUSPENSION

SHOCK ABSORBERS				
BD1366T	2	35mm Nitro Gas Shock		
FC41366B	2	41mm Foam Cell Shock		Suits OE Height
BM401366	2	40mm 9 Stage Adjustable		
BD1382T	2	35mm Nitro Gas Shock		
FC41382B	2	41mm Foam Cell Shock		Suits 40mm Lift
BM401382	2	40mm 9 Stage Adjustable		
LEAF SPRINGS				
T63	2	0-300kg Load		40mm Lift
T63H	2	CONSTANT 300Kg Load		40mm Lift
COMPONENTS				
TDUK-007	1	Urethane Shackle Bushing Kit		
TDUB-012	2	U-Bolt Kit		
TDGS-668	1	Greasable Shackle Kit		
TDGP-669	1	Greasable Pin Kit		
AIR ASSIST BAGS				
TDAA-107	1	Bellows bag kit		Suits 40mm Lift (D22 Only)
TDAA-124	1	Bellows bag kit		Suits std height ONLY (D22 Only)

REPLACEMENT BUSHINGS

QUANTITY PER SHOCK				
TW959	2	Suits Front Top Pin		Pin Style Bushing
404702	2	Suits Top & Bottom Rear Eye		Eyering Bushing
412773	1	Suits Front Bottom Eye		



Fitting sheet (located page 208) must be completed when suspension fitted. Failure to comply may affect warranty.

NISSAN

NAVARA

1/86-15
D21, D22

COMPLETE KIT PRICE REFERENCE

SHOCK CHOICE	SPRING CHOICE	RRP inc GST	CONTENTS
<p>Foam Cell Front Nitro Gas Rear</p> <p><u>Includes</u> 2x Front Shocks 2x Rear Shocks 2x Leaf Springs 1x Urethane Kit 2x U-Bolt Kits</p>	<p>T63 0-300KG Spring</p> <p>T63H CONSTANT 300KG Spring</p>		
<p>41mm Foam Cell</p> <p><u>Includes</u> 2x Front Shocks 2x Rear Shocks 2x Leaf Springs 1x Urethane Kit 2x U-Bolt Kits</p>	<p>T63 0-300KG Spring</p> <p>T63H CONSTANT 300KG Spring</p>		
<p>Foam Cell Front Adjustable Rear</p> <p><u>Includes</u> 2x Front Shocks 2x Rear Shocks 2x Leaf Springs 1x Urethane Kit 2x U-Bolt Kits</p>	<p>T63 0-300KG Spring</p> <p>T63H CONSTANT 300KG Spring</p>		

All prices exclude freight. Include only permanent accessories & weights when selecting springs. Towing weight is not included

P: (02) 9672 8899 | F: (02) 9672 8099



NISSAN

NAVARA

12/05-15

D40 - 2.5L, 4.0L



FRONT SUSPENSION

ESTIMATED LIFT: 40mm

PART NO.	QTY	DESCRIPTION	RRP inc GST	NOTES
SHOCK ABSORBERS				
FC404700	2	40mm Foam Cell Strut		
BM404700	2	40mm Adjustable Strut		9 Stage Adjustable
COIL SPRINGS				
TDC770	2	40mm Lift Spring		Petrol/Diesel/Bar
TDC770H	2	40mm Lift Spring		Petrol/Diesel/Bar/Winch
COMPLETE STRUT ASSEMBLY				
NIS-040/01	2	BM404700/TDC770		Petrol/Diesel/Bar
NIS-040/02	2	BM404700/TDC770H		Petrol/Diesel/Bar/Winch
NIS-040/04	2	FC404700/TDC770		Petrol/Diesel/Bar
NIS-040/05	2	FC404700/TDC770H		Petrol/Diesel/Bar/Winch
REPLACEMENT STRUT TOP				
NIS-3030	2	Strut Top		Replacement Strut Top

REAR SUSPENSION

SHOCK ABSORBERS				
BD1368T	2	35mm Nitro Gas Shock		Up to 40mm Lift (Comfort Use)
FC41368	2	41mm Foam Cell Shock		Up to 40mm Lift
BM401368	2	40mm 9 Stage Adjustable		Up to 40mm Lift
LEAF SPRINGS				
T85C	2	0-300kg Load		40mm Lift
T85L	2	CONSTANT 300Kg Load		40mm Lift
T85LL	2	CONSTANT 500Kg Load		40mm Lift
COMPONENTS				
TDUK-068	1	Urethane Shackle Bushing Kit		
TDUB-016	2	U-Bolt Kit		
TDGS-667	1	Greasable Shackle Kit		
TDGP-668	1	Greasable Pin Kit		
AIR ASSIST BAGS				
TDAA-108	1	Bellows bag kit		Suits 40mm Lift
TDAA-120	1	Bellows bag kit		Suits standard height ONLY

REPLACEMENT BUSHINGS

QUANTITY PER SHOCK				
NIS-3030	1	Replacement Strut Top		Available As Complete Unit Only
ADJ300/40	1	Suits Bottom Front Eying		Eying Bonded Bushing
404702	1	Suits Rear Top Eying		Eying Bushing
TW040-14	1	Suits Rear Bottom Eying		Eying Bushing

Fitting sheet (located page 208) must be completed when suspension fitted. Failure to comply may affect warranty.





Note: Urethane Bushing kit fitting instructions available at toughdog.com.au

NISSAN

NAVARA

12/05-15
D40 - 2.5L, 4.0L

COMPLETE KIT PRICE REFERENCE

SHOCK CHOICE	SPRING CHOICE	RRP inc GST	CONTENTS
<p>Foam Cell Struts Require Assembly</p> <p>Includes</p> <ul style="list-style-type: none"> 2x Front Struts 2x Rear Shocks 2x Front Coils 2x Leaf Springs 1x Urethane Kit 2x U-Bolt Kits 	<p>T85C (Foam Front Gas Rear)</p> <p>T85C (Foam Cell All)</p> <p>T85L CONSTANT 300KG</p> <p>T85LL CONSTANT 500KG</p>		
<p>Foam Cell Complete Assembly Struts</p> <p>Includes</p> <ul style="list-style-type: none"> 2x Complete Struts 2x Rear Shocks 2x Leaf Springs 1x Urethane Kit 2x U-Bolt Kits 	<p>T85C (Foam Front Gas Rear)</p> <p>T85C (Foam Cell All)</p> <p>T85L CONSTANT 300KG</p> <p>T85LL CONSTANT 500KG</p>		
<p>40mm Adjustable Struts Require Assembly</p> <p>Includes</p> <ul style="list-style-type: none"> 2x Front Struts 2x Rear Shocks 2x Front Coils 2x Leaf Springs 1x Urethane Kit 2x U-Bolt Kits 	<p>T85C 0-300KG</p> <p>T85L CONSTANT 300KG</p> <p>T85LL CONSTANT 500KG</p>		
<p>40mm Adjustable Complete Assembly Struts</p> <p>Includes</p> <ul style="list-style-type: none"> 2x Complete Struts 2x Rear Shocks 2x Leaf Springs 1x Urethane Kit 2x U-Bolt Kits 	<p>T85C 0-300KG</p> <p>T85L CONSTANT 300KG</p> <p>T85LL CONSTANT 500KG</p>		

All prices exclude freight. Include only permanent accessories & weights when selecting springs. Towing weight is not included

NISSAN

NAVARA

11-15

D40 - 3.0L STX-550 V6



FRONT SUSPENSION

ESTIMATED LIFT: 40mm

PART NO.	QTY	DESCRIPTION	RRP inc GST	NOTES
SHOCK ABSORBERS				
FC404700	2	40mm Foam Cell Strut		
BM404700	2	40mm Adjustable Strut		9 Stage Adjustable
COIL SPRINGS				
TDC772	2	40mm Lift Spring		Petrol/Diesel/Bar
TDC772H	2	40mm Lift Spring		Petrol/Diesel/Bar/Winch
COMPLETE STRUT ASSEMBLY				
NIS-040/06	2	BM404700/TDC772		Petrol/Diesel/Bar
NIS-040/03	2	BM404700/TDC772H		Petrol/Diesel/Bar/Winch
NIS-040/07	2	FC404700/TDC772		Petrol/Diesel/Bar
NIS-040/08	2	FC404700/TDC772H		Petrol/Diesel/Bar/Winch
REPLACEMENT STRUT TOP				
NIS-3030	2	Strut Top		Replacement Strut Top

REAR SUSPENSION

SHOCK ABSORBERS				
BD1368T	2	35mm Nitro Gas Shock		Up to 40mm Lift (Comfort Use)
FC41368	2	41mm Foam Cell Shock		Up to 40mm Lift
BM401368	2	40mm 9 Stage Adjustable		Up to 40mm Lift
LEAF SPRINGS				
T85C	2	0-300kg Load		40mm Lift
T85L	2	CONSTANT 300Kg Load		40mm Lift
T85LL	2	CONSTANT 500Kg Load		40mm Lift
COMPONENTS				
TDUK-068	1	Urethane Shackle Bushing Kit		
TDUB-016	2	U-Bolt Kit		
TDGS-667	1	Greasable Shackle Kit		
TDGP-668	1	Greasable Pin Kit		
AIR ASSIST BAGS				
TDAA-108	1	Bellows bag kit		Suits 40mm Lift
TDAA-120	1	Bellows bag kit		Suits standard height ONLY

REPLACEMENT BUSHINGS

QUANTITY PER SHOCK				
NIS-3030	1	Replacement Strut Top		Available As Complete Unit Only
ADJ300/40	1	Suits Bottom Front Eying		Eying Bonded Bushing
404702	1	Suits Rear Top Eying		Eying Bushing
TW040-14	1	Suits Rear Bottom Eying		Eying Bushing

Fitting sheet (located page 208) must be completed when suspension fitted. Failure to comply may affect warranty.

Note: Urethane Bushing kit fitting instructions available at toughdog.com.au





NISSAN

NAVARA

11-15

D40 - 3.0L STX-550 V6

COMPLETE KIT PRICE REFERENCE

SHOCK CHOICE	SPRING CHOICE	RRP inc GST	CONTENTS
<p>Foam Cell Struts Require Assembly</p> <p><u>Includes</u> 2x Front Struts 2x Rear Shocks 2x Front Coils 2x Leaf Springs 1x Urethane Kit 2x U-Bolt Kits</p>	<p>T85C (Foam Front Gas Rear)</p> <p>T85C (Foam Cell All)</p> <p>T85L CONSTANT 300KG</p> <p>T85LL CONSTANT 500KG</p>		
<p>Foam Cell Complete Assembly Struts</p> <p><u>Includes</u> 2x Complete Struts 2x Rear Shocks 2x Leaf Springs 1x Urethane Kit 2x U-Bolt Kits</p>	<p>T85C (Foam Front Gas Rear)</p> <p>T85C (Foam Cell All)</p> <p>T85L CONSTANT 300KG</p> <p>T85LL CONSTANT 500KG</p>		
<p>40mm Adjustable Struts Require Assembly</p> <p><u>Includes</u> 2x Front Struts 2x Rear Shocks 2x Front Coils 2x Leaf Springs 1x Urethane Kit 2x U-Bolt Kits</p>	<p>T85C 0-300KG</p> <p>T85L CONSTANT 300KG</p> <p>T85LL CONSTANT 500KG</p>		
<p>40mm Adjustable Complete Assembly Struts</p> <p><u>Includes</u> 2x Complete Struts 2x Rear Shocks 2x Leaf Springs 1x Urethane Kit 2x U-Bolt Kits</p>	<p>T85C 0-300KG</p> <p>T85L CONSTANT 300KG</p> <p>T85LL CONSTANT 500KG</p>		

All prices exclude freight. Include only permanent accessories & weights when selecting springs. Towing weight is not included

P: (02) 9672 8899 | F: (02) 9672 8099



NISSAN

NAVARA

7/15 On

NP300 - Coil Rear Only



FRONT SUSPENSION

ESTIMATED LIFT: 35mm

PART NO.	QTY	DESCRIPTION	RRP inc GST	NOTES
SHOCK ABSORBERS				
FC404710	2	40mm Foam Cell Strut		
BM404710	2	40mm Adjustable Strut		9 Stage Adjustable
COIL SPRINGS				
TDC773	2	35mm Lift Spring		Petrol/Diesel/Bar
TDC773H	2	35mm Lift Spring		Petrol/Diesel/Bar/Winch
COMPLETE STRUT ASSEMBLY				
NIS-300/05	2	BM404710/TDC773		Petrol/Diesel/Bar
NIS-300/06	2	BM404710/TDC773H		Petrol/Diesel/Bar/Winch
NIS-300/07	2	FC404710/TDC773		Petrol/Diesel/Bar
NIS-300/08	2	FC404710/TDC773H		Petrol/Diesel/Bar/Winch
REPLACEMENT STRUT TOP				
NIS-3030	2	Strut Top		Replacement Strut Top

REAR SUSPENSION

SHOCK ABSORBERS				
FC41369	2	41mm Foam Cell Shock		Up to 35mm Lift
BM401369	2	40mm 9 Stage Adjustable		Up to 35mm Lift
COIL SPRINGS				
TDC774	2	0-300kg Load		35mm Lift
TDC774H	2	CONSTANT 300Kg Load		35mm Lift
TDC774VHL	2	CONSTANT 500Kg Load		35mm Lift
COMPONENTS				
TDPR-300	1	Adjustable Panhard Rod		
AIR ASSIST BAGS				
TDAA-007	1	Coil insert bag kit		Suits 35mm Lift
TDAA-016	1	Coil insert bag kit		Suits standard height ONLY

REPLACEMENT BUSHINGS

QUANTITY PER SHOCK				
NIS-3030	1	Replacement Strut Top		Available As Complete Unit Only
ADJ300/40	1	Suits Bottom Front Eying		Eying Bonded Bushing
TW038-16	1	Suits Rear Top Eying		Eying Bushing
TW040-14	1	Suits Rear Bottom Eying		Eying Bushing

Fitting sheet (located page 208) must be completed when suspension fitted. Failure to comply may affect warranty.





NISSAN

NAVARA

7/15 On

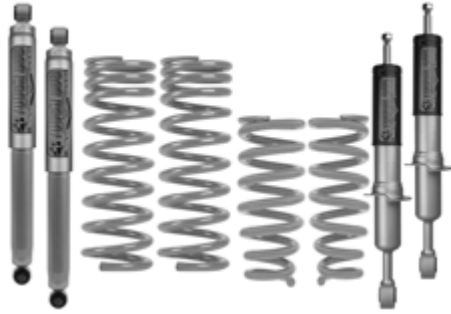
NP300 - Coil Rear Only

COMPLETE KIT PRICE REFERENCE

SHOCK CHOICE	SPRING CHOICE	RRP inc GST	CONTENTS
<p>Foam Cell Struts Require Assembly</p> <p>Includes 2x Front Struts 2x Rear Shocks 2x Front Coils 2x Rear Coils</p>	<p>TDC774 0-300KG Spring</p> <p>TDC774H CONSTANT 300KG Spring</p> <p>TDC774VHL CONSTANT 500KG Spring</p>		
<p>Foam Cell Complete Assembly Struts</p> <p>Includes 2x Front Strut Assembly 2x Rear Shocks 2x Rear Coils</p>	<p>TDC774 0-300KG Spring</p> <p>TDC774H CONSTANT 300KG Spring</p> <p>TDC774VHL CONSTANT 500KG Spring</p>		
<p>40mm Adjustable Struts Require Assembly</p> <p>Includes 2x Front Struts 2x Rear Shocks 2x Front Coils 2x Rear Coils</p>	<p>TDC774 0-300KG Spring</p> <p>TDC774H CONSTANT 300KG Spring</p> <p>TDC774VHL CONSTANT 500KG Spring</p>		
<p>40mm Adjustable Complete Assembly Struts</p> <p>Includes 2x Front Strut Assembly 2x Rear Shocks 2x Rear Coils</p>	<p>TDC774 0-300KG Spring</p> <p>TDC774H CONSTANT 300KG Spring</p> <p>TDC774VHL CONSTANT 500KG Spring</p>		

All prices exclude freight. Include only permanent accessories & weights when selecting springs. Towing weight is not included

P: (02) 9672 8899 | F: (02) 9672 8099



NISSAN

NAVARA

7/15 on

NP300 - Leaf rear only



FRONT SUSPENSION

ESTIMATED LIFT: 35mm

PART NO.	QTY	DESCRIPTION	RRP inc GST	NOTES
SHOCK ABSORBERS				
FC404710	2	40mm Foam Cell Strut		
BM404710	2	40mm Adjustable Strut		9 Stage Adjustable
COIL SPRINGS				
TDC773	2	35mm Lift Spring		Petrol/Diesel/Bar
TDC773H	2	35mm Lift Spring		Petrol/Diesel/Bar/Winch
COMPLETE STRUT ASSEMBLY				
NIS-300/05	2	BM404710/TDC773		Petrol/Diesel/Bar
NIS-300/06	2	BM404710/TDC773H		Petrol/Diesel/Bar/Winch
NIS-300/07	2	FC404710/TDC773		Petrol/Diesel/Bar
NIS-300/08	2	FC404710/TDC773H		Petrol/Diesel/Bar/Winch
REPLACEMENT STRUT TOP				
NIS-3030	2	Strut Top		Replacement Strut Top

REAR SUSPENSION

SHOCK ABSORBERS				
FC43017	2	41mm Foam Cell Shock		Up to 35mm Lift
BM403017	2	40mm 9 Stage Adjustable		Up to 35mm Lift
LEAF SPRINGS				
T86C	2	0-300kg Load		35mm Lift
T86L	2	CONSTANT 300Kg Load		35mm Lift
T86LL	2	CONSTANT 500Kg Load		35mm Lift
COMPONENTS				
TDUK-079	1	Urethane Shackle Bushing Kit		
TDUB-005	2	U-Bolt Kit		
TDGS-669	1	Greasable Shackle Kit		
TDGP-668	1	Greasable Pin Kit		
AIR ASSIST BAGS				
TDAA-109	1	Bellows bag kit		Suits 35mm Lift

REPLACEMENT BUSHINGS

QUANTITY PER SHOCK				
NIS-3030	1	Replacement Strut Top		Available As Complete Unit Only
ADJ300/40	1	Suits Bottom Front Eying		Eying Bonded Bushing
404702	1	Suits Rear Top Eying		Eying Bushing
404702	1	Suits Rear Bottom Eying		Eying Bushing

Fitting sheet (located page 208) must be completed when suspension fitted. Failure to comply may affect warranty.





Note: Urethane Bushing kit fitting instructions available at toughdog.com.au

NISSAN

NAVARA

7/15 on
NP300 - Leaf rear only

COMPLETE KIT PRICE REFERENCE

SHOCK CHOICE	SPRING CHOICE	RRP inc GST	CONTENTS
<p>Foam Cell Struts Require Assembly</p> <p>Includes 2x Front Struts 2x Rear Shocks 2x Front Coils 2x Leaf Springs 1x Urethane Kit 2x U-Bolt Kits</p>	<p>T86C</p> <p>T86L CONSTANT 300KG</p> <p>T86LL CONSTANT 500KG</p>		
<p>Foam Cell Complete Assembly Struts</p> <p>Includes 2x Complete Struts 2x Rear Shocks 2x Leaf Springs 1x Urethane Kit 2x U-Bolt Kits</p>	<p>T86C</p> <p>T86L CONSTANT 300KG</p> <p>T86LL CONSTANT 500KG</p>		
<p>40mm Adjustable Struts Require Assembly</p> <p>Includes 2x Front Struts 2x Rear Shocks 2x Front Coils 2x Leaf Springs 1x Urethane Kit 2x U-Bolt Kits</p>	<p>T86C 0-300KG</p> <p>T86L CONSTANT 300KG</p> <p>T86LL CONSTANT 500KG</p>		
<p>40mm Adjustable Complete Assembly Struts</p> <p>Includes 2x Complete Struts 2x Rear Shocks 2x Leaf Springs 1x Urethane Kit 2x U-Bolt Kits</p>	<p>T86C 0-300KG</p> <p>T86L CONSTANT 300KG</p> <p>T86LL CONSTANT 500KG</p>		

All prices exclude freight. Include only permanent accessories & weights when selecting springs. Towing weight is not included

P: (02) 9672 8899 | F: (02) 9672 8099



NISSAN

PATHFINDER

12/86-95

WNYD21, WHYD21



FRONT SUSPENSION

ESTIMATED LIFT: 30mm

PART NO.	QTY	DESCRIPTION	RRP inc GST	NOTES
SHOCK ABSORBERS				
BD2057T	2	35mm Nitro Gas Shock		Up to 30mm Lift
FC42057B	2	41mm Foam Cell Shock		Up to 30mm Lift
TORSION BARS				
4WTB-1458	1	Replacement Torsion Bars		26mm/1232mm
Adjust Torsion bars after fitting shocks - Ensure a minimum of 60mm Droop is Maintained				
STEERING DAMPERS				
SD14035	1	H/D Replacement Damper		Suits D21 Vehicles Only

REAR SUSPENSION

SHOCK ABSORBERS				
BD1382T	2	35mm Nitro Gas Shock		Up to 30mm Lift
FC41382B	2	41mm Foam Cell Shock		Up to 30mm Lift
BM401382	2	40mm 9 Stage Adjustable		Up to 30mm Lift
COIL SPRINGS				
TDC739	2	0-300kg Load		30mm Lift
TDC739H	2	CONSTANT 300Kg Load		30mm Lift

REPLACEMENT BUSHINGS

QUANTITY PER SHOCK				
TW959	2	Suits Top Front Pin Mount		Pin Style Bushing
404702	2	Suits Rear Top & Bottom Eying		Eying Bushing
412772	1	Suits Bottom Front Eying		Eying Bushing

COMPLETE KIT PRICE REFERENCE

SHOCK CHOICE	SPRING CHOICE	RRP inc GST	CONTENTS
35mm Nitro gas	ANY		
41mm Foam Cell	ANY		
Foam Cell Front Adjustable Rear	ANY		
Includes 2 x Coil Springs 4 x Shocks			

Fitting sheet (located page 208) must be completed when suspension fitted. Failure to comply may affect warranty.



NISSAN

PATHFINDER R50

11/95-99 & 2/99-05
R50 (Series I, II, III)

FRONT SUSPENSION

ESTIMATED LIFT: 30mm

PART NO.	QTY	DESCRIPTION	RRP inc GST	NOTES
SHOCK ABSORBERS				
BDS4002 (D/S)	1	Twin Tube McPherson Strut		OE Height Suit 11/95-99 ONLY
BDS4003 (P/S)	1	Twin Tube McPherson Strut		OE Height Suit 11/95-99 ONLY
BDS4024	2	Twin Tube McPherson Strut		Suits up to 30mm (all models)
COIL SPRINGS				
TDC784S	2	OE Height Lift Spring		OE Height only
TDC784	2	30mm Lift Spring		Suits up to Steel Bar
TDC784H	2	30mm Lift Spring		Suits Bar & Winch

REAR SUSPENSION

SHOCK ABSORBERS				
BD3009T	2	35mm Nitro Gas Shock		OE Height Suit 11/95-99 ONLY
FC43009	2	41mm Foam Cell Shock		OE Height Suit 11/95-99 ONLY
BD3010T	2	35mm Nitro Gas Shock		30mm Lift Suit 11/95-99 ONLY
FC43010	2	41mm Foam Cell Shock		30mm Lift Suit 11/95-99 ONLY
BD3011T	2	35mm Nitro Gas Shock		OE & 30mm 11/99-05 ONLY
FC43011	2	41mm Foam Cell Shock		OE & 30mm 11/99-05 ONLY
COIL SPRINGS				
TDC783S	2	0-300kg Load		OE Height
TDC783	2	0-300kg Load		30mm Lift
TDC783H	2	CONSTANT 300Kg Load		30mm Lift

COMPLETE KIT PRICE REFERENCE

SHOCK CHOICE	SPRING CHOICE	RRP inc GST	CONTENTS
35mm Nitrogen Gas	30mm Lift		
	OE Height (95-99)		
Nitrogen Gas Front Foam Cell Rear	30mm Lift		
	OE Height (99-05)		
<p align="center">Includes</p> <p align="center">2 x Struts 4 x Coil Springs 2 x Rear Shocks</p>			

All prices exclude freight. Include only permanent accessories & weights when selecting springs. Towing weight is not included

P: (02) 9672 8899 | F: (02) 9672 8099



NISSAN

PATHFINDER

11/05-13

R51 - 2.5L, 4.0L



FRONT SUSPENSION

ESTIMATED LIFT: 40mm

PART NO.	QTY	DESCRIPTION	RRP inc GST	NOTES
SHOCK ABSORBERS				
FC404700	2	40mm Foam Cell Strut		
BM404700	2	40mm Adjustable Strut		9 Stage Adjustable
COIL SPRINGS				
TDC770	2	40mm Lift Spring		Petrol/Diesel/Bar
TDC770H	2	40mm Lift Spring		Petrol/Diesel/Bar/Winch
COMPLETE STRUT ASSEMBLY				
NIS-040/01	2	BM404700/TDC770		Petrol/Diesel/Bar
NIS-040/02	2	BM404700/TDC770H		Petrol/Diesel/Bar/Winch
NIS-040/04	2	FC404700/TDC770		Petrol/Diesel/Bar
NIS-040/05	2	FC404700/TDC770H		Petrol/Diesel/Bar/Winch
REPLACEMENT STRUT TOP				
NIS-3030	2	Strut Top		Replacement Strut Top

REAR SUSPENSION

SHOCK ABSORBERS				
FC41347	2	41mm Foam Cell Shock		Up to 40mm Lift
BM401347	2	40mm 9 Stage Adjustable		Up to 40mm Lift
COIL SPRINGS				
TDC771	2	0-300kg Load		40mm Lift
TDC771H	2	CONSTANT 300Kg Load		40mm Lift
TDC771XHD	2	CONSTANT 500Kg Load		40mm Lift
AIR ASSIST BAGS				
TDAA-002	1	Coil insert bag kit (red bag kit)		Suits 40mm Lift
TDAA-018	1	Coil insert bag kit (red bag kit)		Suits standard height ONLY

REPLACEMENT BUSHINGS

QUANTITY PER SHOCK				
NIS-3030	1	Replacement Strut Top		Available As Complete Unit Only
ADJ300/40	1	Suits Bottom Front Eying		Eying Bonded Bushing

Fitting sheet (located page 208) must be completed when suspension fitted. Failure to comply may affect warranty.





NISSAN

PATHFINDER

11/05-13

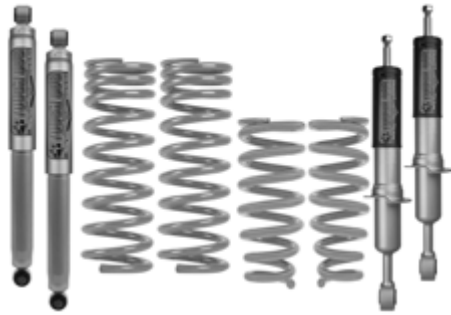
R51 - 2.5L, 4.0L

REAR SUSPENSION

SHOCK CHOICE	SPRING CHOICE	RRP inc GST	CONTENTS
<p>Foam Cell Struts Require Assembly</p> <p>Includes 2x Front Struts 2x Rear Shocks 2x Front Coils 2x Rear Coils</p>	<p>TDC771 0-300KG Spring</p> <p>TDC771H CONSTANT 300KG Spring</p> <p>TDC771XHD CONSTANT 500KG Spring</p>		
<p>Foam Cell Complete Assembly Struts</p> <p>Includes 2x Complete Struts 2x Rear Shocks 2x Rear Coils</p>	<p>TDC771 0-300KG Spring</p> <p>TDC771H CONSTANT 300KG Spring</p> <p>TDC771XHD CONSTANT 500KG Spring</p>		
<p>40mm Adjustable Struts Require Assembly</p> <p>Includes 2x Front Struts 2x Rear Shocks 2x Front Coils 2x Rear Coils</p>	<p>TDC771 0-300KG Spring</p> <p>TDC771H CONSTANT 300KG Spring</p> <p>TDC771XHD CONSTANT 500KG Spring</p>		
<p>40mm Adjustable Complete Assembly Struts</p> <p>Includes 2x Complete Struts 2x Rear Shocks 2x Rear Coils</p>	<p>TDC771 0-300KG Spring</p> <p>TDC771H CONSTANT 300KG Spring</p> <p>TDC771XHD CONSTANT 500KG Spring</p>		

All prices exclude freight. Include only permanent accessories & weights when selecting springs. Towing weight is not included

P: (02) 9672 8899 | F: (02) 9672 8099



NISSAN

PATHFINDER

11/05-13

R51 - 3.0L V6



FRONT SUSPENSION

ESTIMATED LIFT: 40mm

PART NO.	QTY	DESCRIPTION	RRP inc GST	NOTES
SHOCK ABSORBERS				
FC404700	2	40mm Foam Cell Strut		
BM404700	2	40mm Adjustable Strut		9 Stage Adjustable
COIL SPRINGS				
TDC772	2	40mm Lift Spring		Petrol/Diesel/Bar
TDC772H	2	40mm Lift Spring		Petrol/Diesel/Bar/Winch
COMPLETE STRUT ASSEMBLY				
NIS-040/06	2	BM404700/TDC772		Petrol/Diesel/Bar
NIS-040/03	2	BM404700/TDC772H		Petrol/Diesel/Bar/Winch
NIS-040/07	2	FC404700/TDC772		Petrol/Diesel/Bar
NIS-040/08	2	FC404700/TDC772H		Petrol/Diesel/Bar/Winch
REPLACEMENT STRUT TOP				
NIS-3030	2	Strut Top		Replacement Strut Top

REAR SUSPENSION

SHOCK ABSORBERS				
FC41347	2	41mm Foam Cell Shock		Up to 40mm Lift
BM401347	2	40mm 9 Stage Adjustable		Up to 40mm Lift
COIL SPRINGS				
TDC771	2	0-300kg Load		40mm Lift
TDC771H	2	CONSTANT 300Kg Load		40mm Lift
TDC771XHD	2	CONSTANT 500Kg Load		40mm Lift
AIR ASSIST BAGS				
TDAA-002	1	Coil insert bag kit (red bag kit)		Suits 40mm Lift
TDAA-018	1	Coil insert bag kit (red bag kit)		Suits standard height ONLY

REPLACEMENT BUSHINGS

QUANTITY PER SHOCK				
NIS-3030	1	Replacement Strut Top		Available As Complete Unit Only
ADJ300/40	1	Suits Bottom Front Eying		Eying Bonded Bushing
4W-BS101CH	1	Suits top & bottom rear eyering		

Fitting sheet (located page 208) must be completed when suspension fitted. Failure to comply may affect warranty.





NISSAN

PATHFINDER

11/05-13

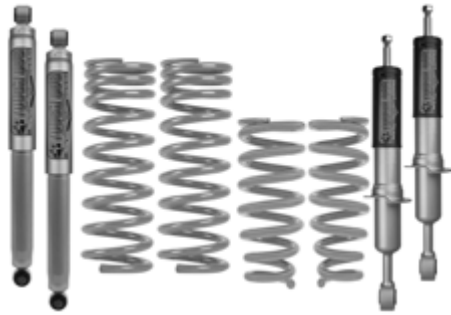
R51 - 3.0L V6

REAR SUSPENSION

SHOCK CHOICE	SPRING CHOICE	RRP inc GST	CONTENTS
<p>Foam Cell Struts Require Assembly</p> <p>Includes 2x Front Struts 2x Rear Shocks 2x Front Coils 2x Rear Coils</p>	<p>TDC771 0-300KG Spring</p> <p>TDC771H CONSTANT 300KG Spring</p> <p>TDC771XHD CONSTANT 500KG Spring</p>		
<p>Foam Cell Complete Assembly Struts</p> <p>Includes 2x Complete Struts 2x Rear Shocks 2x Rear Coils</p>	<p>TDC771 0-300KG Spring</p> <p>TDC771H CONSTANT 300KG Spring</p> <p>TDC771XHD CONSTANT 500KG Spring</p>		
<p>40mm Adjustable Struts Require Assembly</p> <p>Includes 2x Front Struts 2x Rear Shocks 2x Front Coils 2x Rear Coils</p>	<p>TDC771 0-300KG Spring</p> <p>TDC771H CONSTANT 300KG Spring</p> <p>TDC771XHD CONSTANT 500KG Spring</p>		
<p>40mm Adjustable Complete Assembly Struts</p> <p>Includes 2x Complete Struts 2x Rear Shocks 2x Rear Coils</p>	<p>TDC771 0-300KG Spring</p> <p>TDC771H CONSTANT 300KG Spring</p> <p>TDC771XHD CONSTANT 500KG Spring</p>		

All prices exclude freight. Include only permanent accessories & weights when selecting springs. Towing weight is not included

NISSAN PATROL

9/80-88 MQ, MK



FRONT SUSPENSION

ESTIMATED LIFT: 40mm

PART NO.	QTY	DESCRIPTION	RRP inc GST	NOTES
SHOCK ABSORBERS				
BD1005T	2	35mm Nitrogen Gas Shock		
FC41005	2	41mm Foam Cell Shocks		Suit OE Height
BM401005	2	40mm 9 Stage Adjustable Shock		
BD1007T	2	35mm Nitrogen Gas		
FC41007	2	41mm Foam Cell Shocks		Suit 40mm Lift
BM401007	2	40mm 9 Stage Adjustable		
LEAF SPRINGS				
BPN-007	2	Petrol/Diesel/Bar		Suits MQ, MK ONLY
BPN-007H	2	Petrol/Diesel/Bar/Winch		Suits MQ, MK ONLY
STEERING STABILIZERS				
EXT5005	1	H/Duty Replacement Damper		
SS5005-P/S	1	Return to Centre Damper		Suits Power Steering
SS5005-M/S	1	Return to Centre Damper		Suits Manual Steering
COMPONENTS				
TDUK-009	1	Urethane Shackle Bushing Kit		Suits MQ, MK with T.D Springs
TDUK-009 Bush Kit must be used when fitting Tough Dog leaf springs to both MQ and MK Vehicles				
TDUB-009	1	U-Bolt Kit		Suits MQ, MK
TDUB-004	1	U-Bolt Kit		Suits MQ, MK
TDGP-470	1	Greasable pins		
TDGS-355	1	Greasable Shackles		Suits MQ, OE springs
TDGS-665	1	Greasable Shackles		Suits MQ, MK with T.D Springs
TDGS-665 must be fitted when using Tough Dog springs to both MQ and MK Vehicles				
NAK-005	1	Offset Kingpin		0.5 Degree
NAK-075	1	Offset Kingpin		0.75 Degree
NAK-001	1	Offset Kingpin		1.0 Degree

REPLACEMENT BUSHINGS

QUANTITY PER SHOCK				
TW959	4	Suits Top & Bottom Front Pin		Pin Style Bushing

Fitting sheet (located page 208) must be completed when suspension fitted. Failure to comply may affect warranty.

NISSAN PATROL

9/80-88 MQ, MK

REAR SUSPENSION

PART NO.	QTY	DESCRIPTION	RRP inc GST	NOTES
SHOCK ABSORBERS				
BD1400T	2	35mm Nitrogen Gas Shock		Suit OE Height Suits MQ, MK ONLY
FC41400	2	41mm Foam Cell Shocks		
BM401400	2	40mm 9 Stage Adjustable Shock		
BD1441T	2	35mm Nitrogen Gas		Suit 40mm Lift Suits MQ, MK ONLY
FC41441	2	41mm Foam Cell Shocks		
BM401441	2	40mm 9 Stage Adjustable		
LEAF SPRINGS				
BPN-008	2	0-300kg Load		Suits MQ, MK ONLY
BPN-008H	2	CONSTANT 300Kg Load		Suits MQ, MK ONLY
COMPONENTS				
TDUK-010	1	Urethane Shackle Bushing Kit		Suits MQ, MK
TDUB-010	2	U-Bolt Kit		Suits MQ & MK
TDGP-470	1	Greasable pins		
TDGS-664	1	Greasable Shackles		Suits MQ, MK

COMPLETE KIT PRICE REFERENCE

SHOCK CHOICE	SPRING CHOICE	RRP inc GST	CONTENTS
35mm Nitro Gas MQ, MK Only	BPN007+BPN008 BPN007H+BPN008 BPN007+BPN008H BPN007H+BPN008H		 <p>Includes 4 x Leaf Springs 4 x Shocks 2 x Urethane Bushing Kits 4 x U-Bolt Kits</p>
41mm Foam Cell MQ, MK Only	BPN007+BPN008 BPN007H+BPN008 BPN007+BPN008H BPN007H+BPN008H		
40mm 9 Stage Adjustable MQ, MK Only	BPN007+BPN008 BPN007H+BPN008 BPN007+BPN008H BPN007H+BPN008H		

All prices exclude freight. Include only permanent accessories & weights when selecting springs. Towing weight is not included

P: (02) 9672 8899 | F: (02) 9672 8099



NISSAN

PATROL

2/88-98

GQ Patrol (Y60) - 2" Lift



FRONT SUSPENSION

ESTIMATED LIFT: 50mm

PART NO.	QTY	DESCRIPTION	RRP inc GST	NOTES
SHOCK ABSORBERS				
FC41047	2	41mm Foam Cell Shocks		Suits up to 50mm Lift
BM401047	2	40mm 9 Stage Adjustable Shock		Suits up to 50mm Lift
BMX1047/2	2	45mm 9 Stage Adjustable Shock		Suits 50mm Lift ONLY
TDR1047B	2	53mm 'Ralph' Big Bore Shock		Suits up to 50mm Lift
COIL SPRINGS				
TDC731	2	25mm Lift Coil		Suit SWB with Alloy Bar
TDC734SL	2	25mm Lift Coil		Suit LWB up to Bullbar
TDC734HSL	2	25mm Lift Coil		Suit LWB with Bullbar & Winch
TDC734CL	2	50mm Lift Coil		Suit LWB with 2.8L/Alloy Bar
TDC734L	2	50mm Lift Coil		Suit LWB up to Bullbar
TDC734HL	2	50mm Lift Coil		Suit LWB with Bullbar & Winch
STEERING STABILIZERS				
EXT5612	1	H/Duty Replacement Damper		
SS5612-P/S	1	Return to Centre Damper		Suits 2/88-8/89 GQ ONLY
SV5612	1	9 Stage Adjustable Damper		
EXT5613	1	H/Duty Replacement Damper		
SS5613-P/S	1	Return to Centre Damper		Suits 9/89-98 GQ ONLY
SV5613	1	9 Stage Adjustable Damper		
CASTER CORRECTION				
TDUK-054/2	1	2 Degree Caster Correction Bush		instructions at toughdog.com.au
PANHARD ROD (Check Bushes Prior to Ordering)				
TDPR-004	1	Adjustable Panhard Rod		Suits GQ
TDPR-014	1	Adjustable Panhard Rod		Suits GQ LHD ONLY
COMPONENTS				
TDUK-041	1	Front Radius Rod to Chassis		1 Kit required per vehicle
TDUK-050	1	Front Radius Rod to Diff		1 Kit required per vehicle
TDUK-051	1	Panhard Rod Bush Kit		1 Kit required per panhard rod
TDUK-1734/15	1	Urethane Spring Spacer 15mm		1 required per coil as required
TDUK-1734/30	1	Urethane Spring Spacer 30mm		1 required per coil as required
NAK-005	1	Offset Kingpin		0.5 Degree
NAK-075	1	Offset Kingpin		0.75 Degree
NAK-001	1	Offset Kingpin		1.0 Degree

REPLACEMENT BUSHINGS

QUANTITY PER SHOCK				
TW967	4	Suits Top & Bottom Front Pin		Pin Style Bushing
ADJ00191	1	Suits Top Rear Eying		Eying Bushing
415024	1	Suits Bottom Rear Eying		Eying Bushing

Fitting sheet (located page 208) must be completed when suspension fitted. Failure to comply may affect warranty.

KIT PRICING REFERENCE COMPONENTS AS PER IMAGE

please order using part numbers

NISSAN

PATROL

2/88-98

GQ Patrol (Y60) - 2" Lift

REAR SUSPENSION

PART NO.	QTY	DESCRIPTION	RRP inc GST	NOTES
SHOCK ABSORBERS - Fitting BMX? instructions at toughdog.com.au				
FC41206	2	41mm Foam Cell Shocks		Suits up to 50mm Lift
BM401206	2	40mm 9 Stage Adjustable Shock		Suits up to 50mm Lift
BMX1206/2	2	45mm 9 Stage Adjustable Shock		Suits 50mm Lift ONLY
TDR1206	2	53mm 'Ralph' Big Bore Shock		Suits up to 50mm Lift
COIL SPRINGS				
TDC733	2	25mm Lift 0-300Kg Load		Suit SWB
TDC732SL	2	25mm Lift 0-300Kg Load		Suit LWB
TDC732HSL	2	25mm Lift CONSTANT 300kg		Suit LWB
TDC732CL	2	50mm Lift No Load (Comfort)		Suit LWB
TDC732L	2	50mm Lift 0-300Kg Load		Suit LWB
TDC749HL	2	50mm Lift CONSTANT 300kg		Suit LWB
PANHARD ROD (Check Bushes Prior to Ordering)				
TDPR-005	1	Adjustable Panhard Rod		Suits GQ
COMPONENTS				
TDUK-052	1	Trailing Arm Bushing Kit		2 Kits required Upper & Lower
TDUK-051	1	Panhard Rod Bush Kit		1 Kit required per panhard rod
TDUK-1736/15	1	Urethane Spring Spacer 15mm		1 required per coil as required
TDUK-1736/30	1	Urethane Spring Spacer 30mm		1 required per coil as required
AIR ASSIST BAGS				
TDAA-008	1	Coil insert bag kit		Suits 50mm Lift
TDAA-017	1	Coil insert bag kit		Suits standard height ONLY

COMPLETE KIT PRICE REFERENCE

SHOCK CHOICE	SPRING CHOICE	RRP inc GST	CONTENTS
41mm Foam Cell	\$135 Rear Coils		
	\$165 Rear Coils		
40mm 9 Stage Adjustable	\$135 Rear Coils		
	\$165 Rear Coils		
45mm Big Bore 9 Stage Adjustable	\$135 Rear Coils		
	\$165 Rear Coils		
53mm Big Bore 'Ralph'	\$135 Rear Coils		
	\$165 Rear Coils		
Includes 4 x Coil Springs 4 x Shocks			

All prices exclude freight. Include only permanent accessories & weights when selecting springs. Towing weight is not included

P: (02) 9672 8899 | F: (02) 9672 8099



NISSAN

PATROL

12/97-2016

GU Patrol (Y61) - 2" Lift



FRONT SUSPENSION

ESTIMATED LIFT: 50mm

PART NO.	QTY	DESCRIPTION	RRP inc GST	NOTES
SHOCK ABSORBERS				
FC41047	2	41mm Foam Cell Shocks		Suits up to 50mm Lift
BM401047	2	40mm 9 Stage Adjustable Shock		Suits up to 50mm Lift
BMX1047/2	2	45mm 9 Stage Adjustable Shock		Suits 50mm Lift ONLY
TDR1047B	2	53mm 'Ralph' Big Bore Shock		Suits up to 50mm Lift
COIL SPRINGS				
TDC734SL	2	25mm Lift Coil		Suit LWB up to Bullbar
TDC734HSL	2	25mm Lift Coil		Suit LWB with Bullbar & Winch
TDC734L	2	50mm Lift Coil		Suit LWB up to Bullbar
TDC734HL	2	50mm Lift Coil		Suit LWB with Bullbar & Winch
STEERING STABILIZERS				
EXT5000	1	H/Duty Replacement Damper		
SS5000-P/S	1	Return to Centre Damper		Suits 12/97-00 GU ONLY
SV5000	1	9 Stage Adjustable Damper		
EXT5617	1	H/Duty Replacement Damper		
SS5617-P/S	1	Return to Centre Damper		Suits 4/00-15 GU ONLY
SV5617	1	9 Stage Adjustable Damper		
CASTER CORRECTION				
TDUK-054/2	1	2 Degree Caster Correction Bush		instructions at toughdog.com.au
PANHARD ROD (Check Bushes Prior to Ordering)				
TDPR-004	1	Adjustable Panhard Rod		Suits GU Utes
TDPR-012	1	Adjustable Panhard Rod		Suits GU Wagon ONLY
TDPR-014	1	Adjustable Panhard Rod		Suits GU Utes LHD ONLY
TDPR-016	1	Adjustable Panhard Rod		Suits GU Wagon LHD ONLY
COMPONENTS				
TDUK-041	1	Front Radius Rod to Chassis		1 Kit required per vehicle
TDUK-050	1	Front Radius Rod to Diff		1 Kit required per vehicle
TDUK-055	1	Panhard Rod Bush (Diff End)		1 Kit required (diff end only)
TDUK-056	1	Panhard Rod Bush (Chassis End)		1 Kit required (chassis end only)
TDUK-1734/15	1	Urethane Spring Spacer 15mm		1 required per coil as required
TDUK-1734/30	1	Urethane Spring Spacer 30mm		1 required per coil as required
NAK-005	1	Offset Kingpin		0.5 Degree
NAK-075	1	Offset Kingpin		0.75 Degree
NAK-001	1	Offset Kingpin		1.0 Degree

REPLACEMENT BUSHINGS

QUANTITY PER SHOCK				
TW967	4	Suits Top & Bottom Front Pin		Pin Style Bushing
ADJ00191	1	Suits Top Rear Eying		Eying Bushing
415024	1	Suits Bottom Rear Eying		Eying Bushing

Fitting sheet (located page 208) must be completed when suspension fitted. Failure to comply may affect warranty.

**KIT PRICING REFERENCE
COMPONENTS AS PER IMAGE**

please order using part numbers

NISSAN
PATROL
12/97-2016
GU Patrol (Y61) - 2" Lift

REAR SUSPENSION

PART NO.	QTY	DESCRIPTION	RRP inc GST	NOTES
SHOCK ABSORBERS - Fitting BMX? instructions at toughdog.com.au				
FC41206	2	41mm Foam Cell Shocks		Suits up to 50mm Lift
BM401206	2	40mm 9 Stage Adjustable Shock		Suits up to 50mm Lift
BMX1206/2	2	45mm 9 Stage Adjustable Shock		Suits 50mm Lift ONLY
TDR1206	2	53mm 'Ralph' Big Bore Shock		Suits up to 50mm Lift
COIL SPRINGS				
TDC742SL	2	25mm Lift 0-300Kg Load		Suit LWB
TDC742HSL	2	25mm Lift CONSTANT 300kg		Suit LWB
TDC742L	2	50mm Lift 0-300Kg Load		Suit LWB
TDC742HL	2	50mm Lift CONSTANT 300kg		Suit LWB
PANHARD ROD (Check Bushes Prior to Ordering)				
TDPR-005	1	Adjustable Panhard Rod		Suits GU Utes
TDPR-013	1	Adjustable Panhard Rod		Suits GU Wagon ONLY
COMPONENTS				
TDUK-052	1	Trailing Arm Bushing Kit		2 Kits required Upper & Lower
TDUK-055	1	Panhard Rod Bush (Diff End)		1 Kit required (diff end only)
TDUK-056	1	Panhard Rod Bush (Chassis End)		1 Kit required (chassis end only)
TDUK-1736/15	1	Urethane Spring Spacer 15mm		1 required per coil as required
TDUK-1736/30	1	Urethane Spring Spacer 30mm		1 required per coil as required
AIR ASSIST BAGS				
TDAA-008	1	Coil insert bag kit		Suits 50mm Lift

COMPLETE KIT PRICE REFERENCE

SHOCK CHOICE	SPRING CHOICE	RRP inc GST	CONTENTS
41mm Foam Cell	\$135 Rear Coils		
	\$165 Rear Coils		
40mm 9 Stage Adjustable	\$135 Rear Coils		
	\$165 Rear Coils		
45mm Big Bore 9 Stage Adjustable	\$135 Rear Coils		
	\$165 Rear Coils		
53mm Big Bore 'Ralph'	\$135 Rear Coils		
	\$165 Rear Coils		
Includes 4 x Coil Springs 4 x Shocks			

All prices exclude freight. Include only permanent accessories & weights when selecting springs. Towing weight is not included

NISSAN

PATROL

2/88-2016

GQ, GU Patrol (Y60, Y61) - 3" Lift



FRONT SUSPENSION

ESTIMATED LIFT: 75mm (3")

PART NO.	QTY	DESCRIPTION	RRP inc GST	NOTES
SHOCK ABSORBERS				
FC41047/3	2	41mm Foam Cell Shocks		Suits 75mm Lift
BM401047/3	2	40mm 9 Stage Adjustable Shock		Suits 75mm Lift
BMX1047/3	2	45mm 9 Stage Adjustable Shock		Suits 75mm Lift
COIL SPRINGS				
TDC734/3	2	75mm Lift Coil		Suit LWB up to Bullbar
TDC734/3H	2	75mm Lift Coil		Suit LWB with Bullbar & Winch
STEERING STABILIZERS				
EXT5612	1	H/Duty Replacement Damper		Suits 2/88-9/89 GQ ONLY
SS5612-P/S	1	Return to Centre Damper		
SV5612	1	9 Stage Adjustable Damper		
EXT5613	1	H/Duty Replacement Damper		Suits 8/89-98 GQ ONLY
SS5613-P/S	1	Return to Centre Damper		
SV5613	1	9 Stage Adjustable Damper		
EXT5000	1	H/Duty Replacement Damper		Suits 12/97-00 GU ONLY
SS5000-P/S	1	Return to Centre Damper		
SV5000	1	9 Stage Adjustable Damper		
EXT5617	1	H/Duty Replacement Damper		Suits 4/00-15 GU ONLY
SS5617-P/S	1	Return to Centre Damper		
SV5617	1	9 Stage Adjustable Damper		
CASTER CORRECTION				
TDUK-054/2	1	2 Degree Caster Correction Bush		instructions at toughdog.com.au
PANHARD ROD (Check Bushes Prior to Ordering)				
TDPR-004	1	Adjustable Panhard Rod		Suits GQ (all) & GU Utes
TDPR-012	1	Adjustable Panhard Rod		Suits GU Wagon ONLY
TDPR-014	1	Adjustable Panhard Rod		Suits GQ (all) & GU Utes LHD
TDPR-016	1	Adjustable Panhard Rod		Suits GU Wagon LHD
COMPONENTS				
TDUK-041	1	Front Radius Rod to Chassis		1 Kit required per vehicle
TDUK-050	1	Front Radius Rod to Diff		1 Kit required per vehicle
TDUK-051	1	Panhard Rod Bush Kit		Suits TDPR-004 & 014 ONLY
TDUK-055	1	Panhard Rod Bush (Diff End)		(diff end) TDPR-012, 013 & 016
TDUK-056	1	Panhard Rod Bush (Chassis End)		(chassis end) TDPR-012, 013 & 016
NAK-005	1	Offset Kingpin		0.5 Degree
NAK-075	1	Offset Kingpin		0.75 Degree
NAK-001	1	Offset Kingpin		1.0 Degree

REPLACEMENT BUSHINGS

FOR REPLACEMENT BUSHING PART NUMBERS, PLEASE SEE RELEVANT NISSAN PATROL PAGE 118 PREVIOUS IN CATALOGUE

Fitting sheet (located page 208) must be completed when suspension fitted. Failure to comply may affect warranty.

KIT PRICING REFERENCE COMPONENTS AS PER IMAGE

please order using part numbers

NISSAN

PATROL

2/88-2016

GQ, GU Patrol (Y60, Y61) - 3" Lift

REAR SUSPENSION

PART NO.	QTY	DESCRIPTION	RRP inc GST	NOTES
SHOCK ABSORBERS - Fitting BMX? instructions at toughdog.com.au				
FC41206/3	2	41mm Foam Cell Shocks		Suits 75mm Lift
BM401206/3	2	40mm 9 Stage Adjustable Shock		Suits 75mm Lift
BMX1206/3	2	45mm 9 Stage Adjustable Shock		Suits 75mm Lift
COIL SPRINGS				
TDC732/3	2	75mm Lift 0-300Kg Load		Suit LWB
TDC732/3H	2	75mm Lift CONSTANT 300kg		Suit LWB
PANHARD ROD (Check Bushes Prior to Ordering)				
TDPR-005	1	Adjustable Panhard Rod		Suits GQ (all) & GU Utes
TDPR-013	1	Adjustable Panhard Rod		Suits GU Wagon ONLY
COMPONENTS				
TDUK-051	1	Panhard Rod Bush Kit		Suits TDPR-005 ONLY
TDUK-052	1	Trailing Arm Bushing Kit		2 Kits required Upper & Lower
TDUK-055	1	Panhard Rod Bush (Diff End)		1 Kit required (diff end only)
TDUK-056	1	Panhard Rod Bush (Chassis End)		1 Kit required (chassis end only)
TRANSMISSION SPACER				
TDSP-004/2	1	Transmission Spacer Kit		instructions at toughdog.com.au
BRAKE HOSE KITS				
TDBH-001	1	Non ABS Rubber Hose		SUIT VEHICLES UP TO 2002
TDBH-194	1	Non ABS Braided Hose		SUIT VEHICLES UP TO 2002
TDBH-390	1	With ABS Rubber Hose		SUIT VEHICLES 98 ON
TDBH-190	1	With ABS - Braided Hose		SUIT VEHICLES 98 ON
TDBH-400	1	With ABS & Stability - Rubber		SUIT VEHICLES 98 ON

COMPLETE KIT PRICE REFERENCE

SHOCK CHOICE	SPRING CHOICE	RRP inc GST	CONTENTS
41mm Foam Cell	TO SUIT GQ TO SUIT GU		
40mm 9 Stage Adjustable	TO SUIT GQ TO SUIT GU		
45mm Big Bore 9 Stage Adjustable	TO SUIT GQ TO SUIT GU		
<p>Includes</p> <p>4 x Coil Springs 4 x Shocks 1 x Caster correction kit 2 x Panhard Rods 1 x Transmission Spacer 1 x Brake Hose Kit (Brake Hose kit is rubber non ABS - adjust price if required)</p>			

All prices exclude freight. Include only permanent accessories & weights when selecting springs. Towing weight is not included

P: (02) 9672 8899 | F: (02) 9672 8099



NISSAN

PATROL

2/88-2016

GQ, GU Patrol (Y60, Y61) - 4" Lift



FRONT SUSPENSION

ESTIMATED LIFT: 100mm (4")

PART NO.	QTY	DESCRIPTION	RRP inc GST	NOTES
SHOCK ABSORBERS				
FC41047/4	2	41mm Foam Cell Shocks		Suits 100mm Lift
BMX1047/4/5	2	45mm 9 Stage Adjustable Shock		Suits 100mm Lift
COIL SPRINGS				
TDC734/4	2	100mm Lift Coil		Suit LWB up to Bullbar
TDC734/4H	2	100mm Lift Coil		Suit LWB with Bullbar & Winch
STEERING STABILIZERS				
SS5613-XHD	1	H/Duty Return to Centre Damper		Comes with brackets, fitting instructions at toughdog.com.au
SV5613/4	1	9 Stage Adjustable Damper		
CASTER CORRECTION				
TDUK-054/3	1	3 Degree Caster Correction Bush		instructions at toughdog.com.au
PANHARD ROD (Check Bushes Prior to Ordering)				
TDPR-004	1	Adjustable Panhard Rod		Suits GQ (all) & GU Utes
TDPR-012	1	Adjustable Panhard Rod		Suits GU Wagon ONLY
TDPR-014	1	Adjustable Panhard Rod		Suits GQ (all) & GU Utes LHD
TDPR-016	1	Adjustable Panhard Rod		Suits GU Wagon LHD
COMPONENTS				
TDUK-041	1	Front Radius Rod to Chassis		1 Kit required per vehicle
TDUK-050	1	Front Radius Rod to Diff		1 Kit required per vehicle
TDUK-051	1	Pan Hard Rod Bushes		Suits TDPR-004 & 014 ONLY
TDUK-055	1	Panhard Rod Bush (Diff End)		(diff end) TDPR-012, 013 & 016
TDUK-056	1	Panhard Rod Bush (Chassis End)		(chassis end)TDPR-012,013 & 016
NAK-005	1	Offset Kingpin		0.5 Degree
NAK-075	1	Offset Kingpin		0.75 Degree
NAK-001	1	Offset Kingpin		1.0 Degree

REPLACEMENT BUSHINGS

FOR REPLACEMENT BUSHING PART NUMBERS, PLEASE SEE RELEVANT NISSAN PATROL PAGE 118 PREVIOUS IN CATALOGUE

Fitting sheet (located page 208) must be completed when suspension fitted. Failure to comply may affect warranty.

KIT PRICING REFERENCE COMPONENTS AS PER IMAGE

please order using part numbers

NISSAN

PATROL

2/88-2016

GQ, GU Patrol (Y60, Y61) - 4" Lift

REAR SUSPENSION

PART NO.	QTY	DESCRIPTION	RRP inc GST	NOTES
SHOCK ABSORBERS - Fitting BMX? instructions at toughdog.com.au				
FC41206/4	2	41mm Foam Cell Shocks		Suits 100mm Lift
BMX1206/4/5	2	45mm 9 Stage Adjustable Shock		Suits 100mm Lift
COIL SPRINGS				
TDC732/4	2	100mm Lift 0-300Kg Load		Suit LWB
TDC732/4H	2	100mm Lift CONSTANT 300kg		Suit LWB
PANHARD ROD (Check Bushes Prior to Ordering)				
TDPR-005	1	Adjustable Panhard Rod		Suits GQ (all) & GU Utes
TDPR-013	1	Adjustable Panhard Rod		Suits GU Wagon ONLY
COMPONENTS				
TDUK-051	1	Pan Hard Rod Bushes		Suits TDPR-005 ONLY
TDUK-052	1	Trailing Arm Bushing Kit		2 Kits required Upper & Lower
TDUK-055	1	Panhard Rod Bush (Diff End)		1 Kit required (diff end only)
TDUK-056	1	Panhard Rod Bush (Chassis End)		1 Kit required (chassis end only)
TRANSMISSION SPACER				
TDSP-004/2	1	Transmission Spacer Kit		instructions at toughdog.com.au
BRAKE HOSE KITS				
TDBH-001	1	Non ABS Rubber Hose		SUIT VEHICLES UP TO 2002
TDBH-194	1	Non ABS Braided Hose		SUIT VEHICLES UP TO 2002
TDBH-390	1	With ABS Rubber Hose		SUIT VEHICLES 98 ON
TDBH-190	1	With ABS - Braided Hose		SUIT VEHICLES 98 ON
TDBH-400	1	With ABS & Stability - Rubber		SUIT VEHICLES 98 ON

VEHICLES LIFTED 100MM OR MORE REQUIRE THE REAR TAILSHAFT TO BE SPUN 180 DEGREES SO THAT THE CLEARANCE BETWEEN THE CROSS MEMBER AND THE TAILSHAFT IS INCREASED.

COMPLETE KIT PRICE REFERENCE

SHOCK CHOICE	SPRING CHOICE	RRP inc GST	CONTENTS
41mm Foam Cell	TO SUIT GQ TO SUIT GU		
45mm Big Bore 9 Stage Adjustable	TO SUIT GQ TO SUIT GU		
Includes 4 x Coil Springs 4 x Shocks 1 x Caster correction kit 2 x Panhard Rods 1 x Transmission Spacer 1 x Brake Hose Kit (Brake Hose kit is rubber non ABS - adjust price if required)			

All prices exclude freight. Include only permanent accessories & weights when selecting springs. Towing weight is not included

P: (02) 9672 8899 | F: (02) 9672 8099



NISSAN

PATROL

2/88-2016

GQ, GU Patrol (Y60, Y61) - 5" Lift



FRONT SUSPENSION

ESTIMATED LIFT: 125mm (5")

PART NO.	QTY	DESCRIPTION	RRP inc GST	NOTES
SHOCK ABSORBERS				
BMX1047/4/5	2	45mm 9 Stage Adjustable Shock		Suits 125mm Lift ONLY
COIL SPRINGS				
TDC734/5	2	125mm Lift Coil		Suit LWB up to Bullbar
TDC734/5H	2	125mm Lift Coil		Suit LWB with Bullbar & Winch
STEERING STABILIZERS				
SS5613-XHD	1	H/Duty Return to Centre Damper		Comes with brackets, fitting instructions at toughdog.com.au
SV5613/4	1	9 Stage Adjustable Damper		
CASTER CORRECTION				
TDCP-005	1	5 Degree Caster Correction Plate		instructions at toughdog.com.au
PANHARD ROD (Check Bushes Prior to Ordering)				
TDPR-004	1	Adjustable Panhard Rod		Suits GQ (all) & GU Utes
TDPR-012	1	Adjustable Panhard Rod		Suits GU Wagon ONLY
TDPR-014	1	Adjustable Panhard Rod		Suits GQ (all) & GU Utes LHD
TDPR-016	1	Adjustable Panhard Rod		Suits GU Wagon LHD
COMPONENTS				
TDUK-041	1	Front Radius Rod to Chassis		1 Kit required per vehicle
TDUK-050	1	Front Radius Rod to Diff		1 Kit required per vehicle
TDUK-051	1	Pan Hard Rod Bushes		Suits TDPR-004 & 014 ONLY
TDUK-055	1	Panhard Rod Bush (Diff End)		(diff end) TDPR-012, 013 & 016
TDUK-056	1	Panhard Rod Bush (Chassis End)		(chassis end) TDPR-012, 013 & 016
NAK-005	1	Offset Kingpin		0.5 Degree
NAK-075	1	Offset Kingpin		0.75 Degree
NAK-001	1	Offset Kingpin		1.0 Degree

REPLACEMENT BUSHINGS

FOR REPLACEMENT BUSHING PART NUMBERS, PLEASE SEE RELEVANT NISSAN PATROL PAGE 118 PREVIOUS IN CATALOGUE

Fitting sheet (located page 208) must be completed when suspension fitted. Failure to comply may affect warranty.

**KIT PRICING REFERENCE
COMPONENTS AS PER IMAGE**

please order using part numbers

NISSAN

PATROL

2/88-2016

GQ, GU Patrol (Y60, Y61) - 5" Lift

REAR SUSPENSION

PART NO.	QTY	DESCRIPTION	RRP inc GST	NOTES
SHOCK ABSORBERS - Shock fitting instructions at toughdog.com.au				
BMX1206/4/5	2	45mm 9 Stage Adjustable Shock		Suits 125mm Lift ONLY
COIL SPRINGS				
TDC732/5	2	125mm Lift 0-300Kg Load		Suit LWB
TDC732/5H	2	125mm Lift CONSTANT 300kg		Suit LWB
PANHARD ROD (Check Bushes Prior to Ordering)				
TDPR-005	1	Adjustable Panhard Rod		Suits GQ (all) & GU Utes
TDPR-013	1	Adjustable Panhard Rod		Suits GU Wagon ONLY
COMPONENTS				
TDUK-051	1	Pan Hard Rod Bushes		Suits TDPR-005 ONLY
TDUK-052	1	Trailing Arm Bushing Kit		2 Kits required Upper & Lower
TDUK-055	1	Panhard Rod Bush (Diff End)		1 Kit required (diff end only)
TDUK-056	1	Panhard Rod Bush (Chassis End)		1 Kit required (chassis end only)
TRANSMISSION SPACER				
TDSP-004/2	1	Transmission Spacer Kit		instructions at toughdog.com.au
BRAKE HOSE KITS				
TDBH-001	1	Non ABS Rubber Hose		SUIT VEHICLES UP TO 2002
TDBH-194	1	Non ABS Braided Hose		SUIT VEHICLES UP TO 2002
TDBH-390	1	With ABS Rubber Hose		SUIT VEHICLES 98 ON
TDBH-190	1	With ABS - Braided Hose		SUIT VEHICLES 98 ON
TDBH-400	1	With ABS & Stability - Rubber		SUIT VEHICLES 98 ON

VEHICLES LIFTED 100MM OR MORE REQUIRE THE REAR TAILSHAFT TO BE SPUN 180 DEGREES SO THAT THE CLEARANCE BETWEEN THE CROSS MEMBER AND THE TAILSHAFT IS INCREASED.

COMPLETE KIT PRICE REFERENCE

SHOCK CHOICE	SPRING CHOICE	RRP inc GST	CONTENTS
45mm Big Bore 9 Stage Adjustable	TO SUIT GQ (0-300 rear)		
	TO SUIT GQ (300kg + rear)		
	TO SUIT GU (0-300 rear)		
	TO SUIT GU (300kg + rear)		
Includes 4 x Coil Springs 4 x Shocks 1 x Caster correction kit 2 x Panhard Rods 1 x Transmission Spacer 1 x Brake Hose Kit (Brake Hose kit is rubber non ABS - adjust price if required)			

All prices exclude freight. Include only permanent accessories & weights when selecting springs. Towing weight is not included

P: (02) 9672 8899 | F: (02) 9672 8099



NISSAN

PATROL

2/88-2016

GQ, GU Patrol (Y60, Y61) - 6" Lift



FRONT SUSPENSION

ESTIMATED LIFT: 150mm (6")

PART NO.	QTY	DESCRIPTION	RRP inc GST	NOTES
SHOCK ABSORBERS				
BMX1047/6	2	45mm 9 Stage Adjustable Shock		Suits 150mm Lift ONLY
COIL SPRINGS				
TDC734/6	2	150mm Lift Coil		Suit LWB up to Bullbar
TDC734/6H	2	150mm Lift Coil		Suit LWB with Bullbar & Winch
STEERING STABILIZERS				
SS5613-XHD	1	H/Duty Replacement Damper		Comes with brackets, fitting instructions at toughdog.com.au
SV5613/4	1	9 Stage Adjustable Damper		
CASTER CORRECTION				
TDCP-007	1	7 Degree Caster Correction Plate		instructions at toughdog.com.au
PANHARD ROD (Check Bushes Prior to Ordering)				
TDPR-004	1	Adjustable Panhard Rod		Suits GQ (all) & GU Utes
TDPR-012	1	Adjustable Panhard Rod		Suits GU Wagon ONLY
TDPR-014	1	Adjustable Panhard Rod		Suits GQ (all) & GU Utes LHD
TDPR-016	1	Adjustable Panhard Rod		Suits GU Wagon LHD
COMPONENTS				
TDUK-041	1	Front Radius Rod to Chassis		1 Kit required per vehicle
TDUK-050	1	Front Radius Rod to Diff		1 Kit required per vehicle
TDUK-051	1	Pan Hard Rod Bushes		Suits TDPR-004 & 014 ONLY
TDUK-055	1	Panhard Rod Bush (Diff End)		(diff end) TDPR-012, 013 & 016
TDUK-056	1	Panhard Rod Bush (Chassis End)		(chassis end) TDPR-012, 013 & 016
NAK-005	1	Offset Kingpin		0.5 Degree
NAK-075	1	Offset Kingpin		0.75 Degree
NAK-001	1	Offset Kingpin		1.0 Degree

REPLACEMENT BUSHINGS

FOR REPLACEMENT BUSHING PART NUMBERS, PLEASE SEE RELEVANT NISSAN PATROL PAGE 118 PREVIOUS IN CATALOGUE

Fitting sheet (located page 208) must be completed when suspension fitted. Failure to comply may affect warranty.

KIT PRICING REFERENCE COMPONENTS AS PER IMAGE

please order using part numbers

NISSAN

PATROL

2/88-2016

GQ, GU Patrol (Y60, Y61) - 6" Lift

REAR SUSPENSION

PART NO.	QTY	DESCRIPTION	RRP inc GST	NOTES
SHOCK ABSORBERS - Shock fitting instructions at toughdog.com.au				
BMX1206/6	2	45mm 9 Stage Adjustable Shock		Suits 150mm Lift ONLY
COIL SPRINGS				
TDC732/6	2	150mm Lift 0-300Kg Load		Suit LWB
TDC732/6H	2	150mm Lift CONSTANT 300kg		Suit LWB
PANHARD ROD (Check Bushes Prior to Ordering)				
TDPR-005	1	Adjustable Panhard Rod		Suits GQ (all) & GU Utes
TDPR-013	1	Adjustable Panhard Rod		Suits GU Wagon ONLY
COMPONENTS				
TDUK-051	1	Pan Hard Rod Bushes		Suits TDPR-005 ONLY
TDUK-052	1	Trailing Arm Bushing Kit		2 Kits required Upper & Lower
TDUK-055	1	Panhard Rod Bush (Diff End)		1 Kit required (diff end only)
TDUK-056	1	Panhard Rod Bush (Chassis End)		1 Kit required (chassis end only)
TRANSMISSION SPACER				
TDSP-004/2	1	Transmission Spacer Kit		instructions at toughdog.com.au
BRAKE HOSE KITS				
TDBH-001	1	Non ABS Rubber Hose		SUIT VEHICLES UP TO 2002
TDBH-194	1	Non ABS Braided Hose		SUIT VEHICLES UP TO 2002
TDBH-390	1	With ABS Rubber Hose		SUIT VEHICLES 98 ON
TDBH-190	1	With ABS - Braided Hose		SUIT VEHICLES 98 ON
TDBH-400	1	With ABS & Stability - Rubber		SUIT VEHICLES 98 ON

COMPLETE KIT PRICE REFERENCE

SHOCK CHOICE	SPRING CHOICE	RRP inc GST	CONTENTS
45mm Big Bore 9 Stage Adjustable	SUIT GQ (0-300kg)		
	SUIT GQ (Bar+Winch)		
	SUIT GQ (Bar+Winch+300kg Rear)		
	SUIT GU (0-300kg)		
	SUIT GU (Bar+Winch)		
	SUIT GU (Bar+Winch+300kg Rear)		
Includes 4 x Coil Springs 4 x Shocks 1 x Caster correction kit 2 x Panhard Rods 1 x Transmission Spacer 1 x Brake Hose Kit (Brake Hose kit is rubber non ABS - adjust price if required)			

All prices exclude freight. Include only permanent accessories & weights when selecting springs. Towing weight is not included

P: (02) 9672 8899 | F: (02) 9672 8099



NISSAN

PATROL

2/88-97

GQ Cab Chassis (Leaf/Leaf)



FRONT SUSPENSION

ESTIMATED LIFT: 50mm

PART NO.	QTY	DESCRIPTION	RRP inc GST	NOTES
SHOCK ABSORBERS				
FC41108	2	41mm Foam Cell Shocks		Suit OE Height
BM401108	2	40mm 9 Stage Adjustable Shock		
FC41113	2	41mm Foam Cell Shocks		Suit 50mm Lift
BM401113	2	40mm 9 Stage Adjustable		
LEAF SPRINGS				
FS37	2	50mm Lift Spring		Petrol/Diesel/Bar
FS37H	2	50mm Lift Spring		Petrol/Diesel/Bar/Winch
STEERING STABILIZERS				
EXT5005	1	H/Duty Replacement Damper		Eye/Eye Mounting Check Vehicle Prior to Ordering.
SS5005-P/S	1	Return to Centre Damper		
EXT5613	1	H/Duty Replacement Damper		Pin/Pin Mounting Check Vehicle Prior to Ordering.
SS5613-P/S	1	Return to Centre Damper		
SV5613	1	9 Stage Adjustable Dampers		
COMPONENTS				
TDUK-011	1	Urethane Shackle Bushing Kit		
TDUB-011	2	U-Bolt Kit		
TDGP-667	1	Greasable pins		
TDGS-357	1	Greasable Shackles		
NAK-005	1	Offset Kingpin		0.5 Degree
NAK-075	1	Offset Kingpin		0.75 Degree
NAK-001	1	Offset Kingpin		1.0 Degree

REPLACEMENT BUSHINGS

QUANTITY PER SHOCK				
TW959	2	Suits Top Front Pin		Pin Style Bushing
ADJ00191	1	Suits Bottom Front Eying		Eying Bushing
ADJ00191	1	Suits Top Rear Eying		Eying Bushing
TW959	2	Suits Bottom Rear Pin		Pin Style Bushing

Fitting sheet (located page 208) must be completed when suspension fitted. Failure to comply may affect warranty.

**KIT PRICING REFERENCE
COMPONENTS AS PER IMAGE**

please order using part numbers

NISSAN

PATROL

2/88-97

GQ Cab Chassis (Leaf/Leaf)

REAR SUSPENSION

PART NO.	QTY	DESCRIPTION	RRP inc GST	NOTES
SHOCK ABSORBERS				
FC41404	2	41mm Foam Cell Shocks		Suit 50mm Lift
BM401404	2	40mm 9 Stage Adjustable		
LEAF SPRINGS				
BPN-010	2	0-300kg Load		50mm Lift Spring
BPN-010H	2	CONSTANT 300Kg Load		50mm Lift Spring
FS39M	2	CONSTANT 500Kg Load		50mm Lift Spring
FS38M	2	Mine Spec - CONSTANT GVM		50mm Lift Spring
COMPONENTS				
TDUK-012	1	Urethane Shackle Bushing Kit		
TDUB-025	2	U-Bolt Kit		
TDGP-667	1	Greasable pins		
TDGS-357	1	Greasable Shackles		
AIR ASSIST BAGS				
TDAA-110	1	Bellows bag kit		Suits 50mm Lift

COMPLETE KIT PRICE REFERENCE

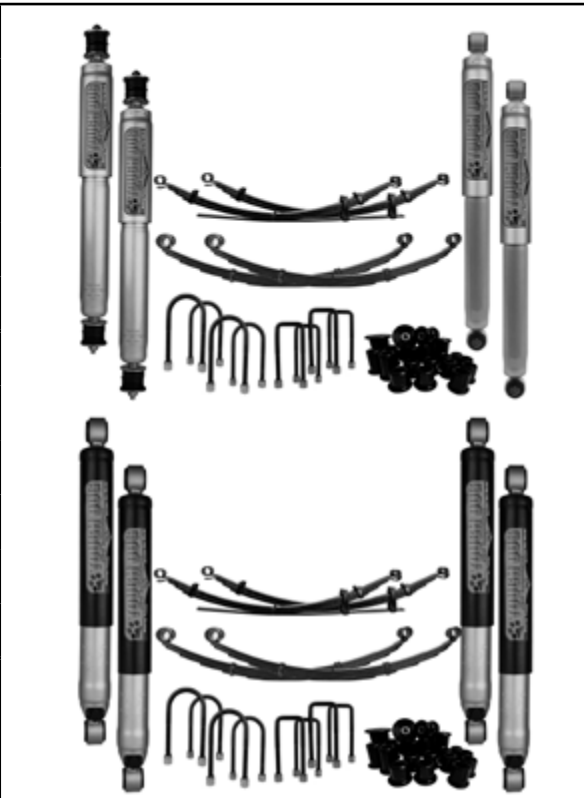
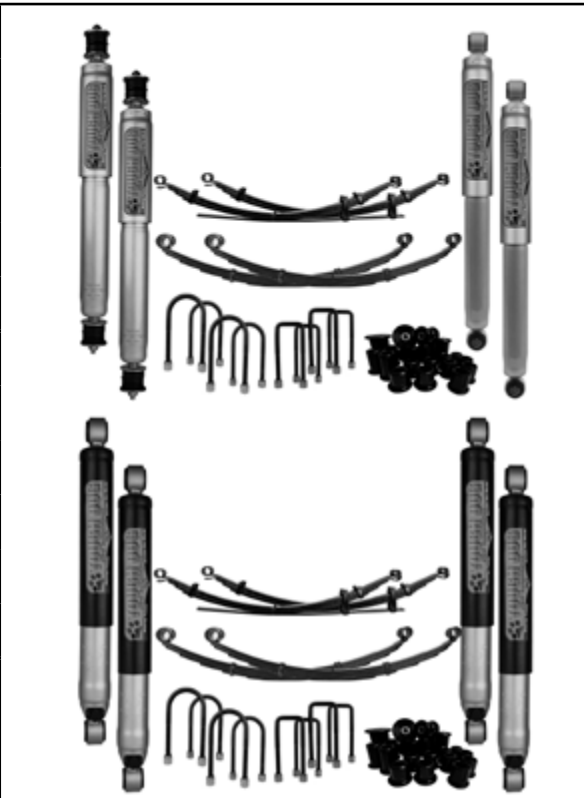
SHOCK CHOICE	SPRING CHOICE	RRP inc GST	CONTENTS
41mm Foam Cell	FS37+BPN-010		
	FS37H+BPN-010		
	FS37+BPN-010H		
	FS37H+BPN010H		
	FS37+FS38/39M		
	FS37H+FS38/39M		
40mm 9 Stage Adjustable	FS37+BPN-010		
	FS37H+BPN-010		
	FS37+BPN-010H		
	FS37H+BPN010H		
	FS37+FS38/39M		
	FS37H+FS38/39M		
Includes			
4 x Leaf Springs 4 x Shocks			
2 x Urethane Kits 4 x U-Bolt Kits			

All prices exclude freight. Include only permanent accessories & weights when selecting springs. Towing weight is not included

P: (02) 9672 8899 | F: (02) 9672 8099



NISSAN

PATROL

92-16

GQ, GU Cab Chassis (Coil/Leaf)



FRONT SUSPENSION

ESTIMATED LIFT: 50mm

PART NO.	QTY	DESCRIPTION	RRP inc GST	NOTES
SHOCK ABSORBERS				
FC41047	2	41mm Foam Cell Shocks		Suits up to 50mm Lift
BM401047	2	40mm 9 Stage Adjustable Shock		Suits up to 50mm Lift
BMX1047/2	2	45mm 9 Stage Adjustable Shock		Suits 50mm Lift ONLY
TDR1047B	2	53mm 'Ralph' Big Bore Shock		Suits up to 50mm Lift
COIL SPRINGS				
TDC734L	2	50mm Lift Coil		Suit up to Bullbar
TDC734HL	2	50mm Lift Coil		Suit with Bullbar & Winch
STEERING STABILIZERS				
EXT5613	1	H/Duty Replacement Damper		Suits GQ ONLY (Pin/Pin)
SS5613-P/S	1	Return to Centre Damper		Please Check Mountings Prior to Ordering - Model is not consistent in application.
SV5613	1	9 Stage Adjustable Damper		
EXT5000	1	H/Duty Replacement Damper		Suits GU ONLY (Pin/Pin)
SS5000-P/S	1	Return to Centre Damper		Please Check Mountings Prior to Ordering - Model is not consistent in application.
SV5000	1	9 Stage Adjustable Damper		
CASTER CORRECTION				
TDUK-054/2	1	2 Degree Caster Correction Bush		1 Kit required per vehicle
PANHARD ROD (Check Bushes Prior to Ordering)				
TDPR-004	1	Adjustable Panhard Rod		Suits GQ & GU Utes
TDPR-014	1	Adjustable Panhard Rod		Suits GQ & GU Utes LHD
COMPONENTS				
TDUK-041	1	Front Radius Rod to Chassis		1 Kit required per vehicle
TDUK-050	1	Front Radius Rod to Diff		1 Kit required per vehicle
TDUK-051	1	Panhard Rod Bush Kit		1 Kit required per panhard rod
TDUK-1734/15	1	Urethane Spring Spacer 15mm		1 required per coil as required
TDUK-1734/30	1	Urethane Spring Spacer 30mm		1 required per coil as required
NAK-005	1	Offset Kingpin		0.5 Degree
NAK-075	1	Offset Kingpin		0.75 Degree
NAK-001	1	Offset Kingpin		1.0 Degree

REPLACEMENT BUSHINGS

QUANTITY PER SHOCK				
TW967	4	Suits Top & Bottom Front Pin		Pin Style Bushing
ADJ00191	1	Suits Top Rear Eying		Eying Bushing
TW959	2	Suits Bottom Rear Pin		Pin Style Bushing

Fitting sheet (located page 208) must be completed when suspension fitted. Failure to comply may affect warranty.

KIT PRICING REFERENCE COMPONENTS AS PER IMAGE

please order using part numbers

NISSAN

PATROL

92-16

GQ, GU Cab Chassis (Coil/Leaf)

REAR SUSPENSION

PART NO.	QTY	DESCRIPTION	RRP inc GST	NOTES
SHOCK ABSORBERS				
FC41404	2	41mm Foam Cell Shocks		Suits up to 50mm Lift
BM401404	2	40mm 9 Stage Adjustable		Suits up to 50mm Lift
BMX1404/2	2	45mm 9 Stage Adjustable Shock		Suits 50mm Lift ONLY
TDR1404	2	53mm 'Ralph' Big Bore Shock		Suits up to 50mm Lift
LEAF SPRINGS				
BPN-010	2	0-300kg Load		50mm Lift Spring
BPN-010H	2	CONSTANT 300Kg Load		50mm Lift Spring
FS39M	2	CONSTANT 500Kg Load		50mm Lift Spring
FS38M	2	Mine Spec - CONSTANT GVM		50mm Lift Spring
COMPONENTS				
TDUK-012	1	Urethane Shackle Bushing Kit		
TDUB-023	2	U-Bolt Kit		
TDGP-667	1	Greasable pins		
TDGS-357	1	Greasable Shackles		
AIR ASSIST BAGS				
TDAA-111	1	Bellows bag kit		Suits 50mm Lift

COMPLETE KIT PRICE REFERENCE

SHOCK CHOICE	SPRING CHOICE	RRP inc GST	CONTENTS
41mm Foam Cell	BPN-010 BPN-010H FS38/39M		
40mm 9 Stage Adjustable	BPN-010 BPN-010H FS38/39M		
45mm Big Bore 9 Stage Adjustable	BPN-010 BPN-010H FS38/39M		
53mm Big Bore 'Ralph'	BPN-010 BPN-010H FS38/39M		
Includes 2 x Coil Springs 4 x Shocks 2 x Leaf Springs 1 x Urethane Kit 2 x U-Bolt Kits			

NISSAN

PATROL

88-16

GQ, GU Cab Chassis (Coil/Coil)



FRONT SUSPENSION

ESTIMATED LIFT: 50mm

PART NO.	QTY	DESCRIPTION	RRP inc GST	NOTES
SHOCK ABSORBERS				
FC41047	2	41mm Foam Cell Shocks		Suits up to 50mm Lift
BM401047	2	40mm 9 Stage Adjustable Shock		Suits up to 50mm Lift
BMX1047/2	2	45mm 9 Stage Adjustable Shock		Suits 50mm Lift ONLY
TDR1047B	2	53mm 'Ralph' Big Bore Shock		Suits up to 50mm Lift
COIL SPRINGS				
TDC734L	2	50mm Lift Coil		Suit up to Bullbar
TDC734HL	2	50mm Lift Coil		Suit with Bullbar & Winch
STEERING STABILIZERS				
EXT5613	1	H/Duty Replacement Damper		Suits GQ ONLY (Pin/Pin)
SS5613-P/S	1	Return to Centre Damper		Please Check Mountings Prior to Ordering - Model is not consistent in application.
SV5613	1	9 Stage Adjustable Damper		
EXT5000	1	H/Duty Replacement Damper		Suits GU ONLY (Pin/Pin)
SS5000-P/S	1	Return to Centre Damper		Please Check Mountings Prior to Ordering - Model is not consistent in application.
SV5000	1	9 Stage Adjustable Damper		
CASTER CORRECTION				
TDUK-054/2	1	2 Degree Caster Correction Bush		1 Kit required per vehicle
PANHARD ROD (Check Bushes Prior to Ordering)				
TDPR-004	1	Adjustable Panhard Rod		Suits GQ & GU Utes
COMPONENTS				
TDUK-041	1	Front Radius Rod to Chassis		1 Kit required per vehicle
TDUK-050	1	Front Radius Rod to Diff		1 Kit required per vehicle
TDUK-051	1	Panhard Rod Bush Kit		1 Kit required per panhard rod
TDUK-1734/15	1	Urethane Spring Spacer 15mm		1 required per coil as required
TDUK-1734/30	1	Urethane Spring Spacer 30mm		1 required per coil as required
NAK-005	1	Offset Kingpin		0.5 Degree
NAK-075	1	Offset Kingpin		0.75 Degree
NAK-001	1	Offset Kingpin		1.0 Degree

REPLACEMENT BUSHINGS

QUANTITY PER SHOCK				
TW967	4	Suits Top & Bottom Front Pin		Pin Style Bushing
ADJ00191	1	Suits Top Rear Eying		Eying Bushing
415024	1	Suits Bottom Rear Eying		Eying Bushing

Fitting sheet (located page 208) must be completed when suspension fitted. Failure to comply may affect warranty.

KIT PRICING REFERENCE COMPONENTS AS PER IMAGE

please order using part numbers

NISSAN

PATROL

88-16

GQ, GU Cab Chassis (Coil/Coil)

REAR SUSPENSION

PART NO.	QTY	DESCRIPTION	RRP inc GST	NOTES
SHOCK ABSORBERS - Fitting BMX? instructions at toughdog.com.au				
FC41206	2	41mm Foam Cell Shocks		Suits up to 50mm Lift
BM401206	2	40mm 9 Stage Adjustable Shock		Suits up to 50mm Lift
BMX1206/2	2	45mm 9 Stage Adjustable Shock		Suits 50mm Lift ONLY
TDR1206	2	53mm 'Ralph' Big Bore Shock		Suits up to 50mm Lift
COIL SPRINGS				
TDC749HL	2	50mm Lift 0-300Kg Load		
TDC749VHL	2	50mm Lift CONSTANT 300kg		
PANHARD ROD (Check Bushes Prior to Ordering)				
TDPR-005	1	Adjustable Panhard Rod		
COMPONENTS				
TDUK-051	1	Pan Hard Rod Bushes		Suits TDPR-005 ONLY
TDUK-052	1	Trailing Arm Bushing Kit		2 Kits required Upper & Lower
TDUK-1736/15	1	Urethane Spring Spacer 15mm		1 required per coil as required
TDUK-1736/30	1	Urethane Spring Spacer 30mm		1 required per coil as required

COMPLETE KIT PRICE REFERENCE

SHOCK CHOICE	SPRING CHOICE	RRP inc GST	CONTENTS
41mm Foam Cell	\$ 165 Rear Coils		
	\$ 196 Rear Coils		
40mm 9 Stage Adjustable	\$ 165 Rear Coils		
	\$ 196 Rear Coils		
45mm Big Bore 9 Stage Adjustable	\$ 165 Rear Coils		
	\$ 196 Rear Coils		
53mm Big Bore 'Ralph'	\$ 165 Rear Coils		
	\$ 196 Rear Coils		
<p align="center">Includes 4 x Coil Springs 4 x Shocks</p>			

All prices exclude freight. Include only permanent accessories & weights when selecting springs. Towing weight is not included

P: (02) 9672 8899 | F: (02) 9672 8099



NISSAN

PATROL

2013 On

Y62 (Non Hydraulic Suspension Only)



FRONT SUSPENSION

ESTIMATED LIFT: 40mm

PART NO.	QTY	DESCRIPTION	RRP inc GST	NOTES
SHOCK ABSORBERS				
FC404750	2	40mm Foam Cell Strut		
BM404750	2	40mm Adjustable Strut		9 Stage Adjustable
BMX454750	2	45mm Adjustable Strut		9 Stage Big Bore Adjustable
COIL SPRINGS				
TDC790L	2	40mm Lift Spring		Petrol With Bar
TDC790HL	2	40mm Lift Spring		Petrol with Bar & Winch
TDC791L	2	40mm Lift Spring-45mm Adj Only		Petrol With Bar
TDC791HL	2	40mm Lift Spring-45mm Adj Only		Petrol with Bar & Winch
COMPLETE STRUT ASSEMBLY				
NIS-062/02	2	FC404750/TDC790L		Petrol With Bar
NIS-062/03	2	FC404750/TDC790HL		Petrol with Bar & Winch
NIS-062/07	2	BM404750/TDC790L		Petrol With Bar
NIS-062/08	2	BM404750/TDC790HL		Petrol with Bar & Winch
NIS-062/10	2	BMX454750/TDC791L (45mm)		Petrol With Bar
NIS-062/11	2	BMX454750/TDC791HL (45mm)		Petrol with Bar & Winch
REPLACEMENT STRUT TOP				
NIS-062	2	Strut Top		Replacement Strut Top

REAR SUSPENSION

SHOCK ABSORBERS				
FC41220	2	41mm Foam Cell Shock		Up to 40mm Lift
BM401220	2	40mm 9 Stage Adjustable		Up to 40mm Lift
BMX1220/2	2	45mm 9 Stage Adjustable		Up to 40mm Lift
COIL SPRINGS				
TDC795	2	0-120kg Load		40mm Lift
TDC795L	2	CONSTANT 120-300Kg Load		40mm Lift
TDC795HL	2	CONSTANT 300Kg Load		40mm Lift
AIR ASSIST BAGS				
TDAA-022	2	Air Assist Bellows		Suit 40mm Lift ONLY
TDAA-023	2	Air Assist Bellows		Suit Standard Height ONLY

REPLACEMENT BUSHINGS

QUANTITY PER SHOCK				
NIS-062	1	Replacement Strut Top		Available As Complete Unit Only
4WAY-002	1	Suits Bottom Front Eying		Eying Bonded Bushing
Retainer-W + Retainer X	1	Suits Rear Top Pin		One of ea req'd - upper and lower
ADJ27805	1	Suits Rear Bottom Eying		Eying Bonded Bushing

Fitting sheet (located page 208) must be completed when suspension fitted. Failure to comply may affect warranty.

NISSAN

PATROL

2013 On

Y62 (Non Hydraulic Suspension Only)

COMPLETE KIT PRICE REFERENCE

SHOCK CHOICE	SPRING CHOICE	RRP inc GST	CONTENTS
<p>Foam Cell Struts Require Assembly Includes 4 x Coil Springs 4 x Shocks</p>	<p>\$165 Rear Coils</p> <p>\$185 Rear Coils</p>		
<p>Foam Cell Complete Assembly Struts Includes 2 x Front Strut Assy 2 x Coil Springs 2 x Rear Shocks</p>	<p>\$165 Rear Coils</p> <p>\$185 Rear Coils</p>		
<p>40mm Adjustable Struts Require Assembly Includes 4 x Coil Springs 4 x Shocks</p>	<p>\$165 Rear Coils</p> <p>\$185 Rear Coils</p>		
<p>40mm Adjustable Complete Assembly Struts Includes 2 x Front Strut Assy 2 x Coil Springs 2 x Rear Shocks</p>	<p>\$165 Rear Coils</p> <p>\$185 Rear Coils</p>		
<p>45mm Adjustable Struts Require Assembly Includes 4 x Coil Springs 4 x Shocks</p>	<p>\$165 Rear Coils</p> <p>\$185 Rear Coils</p>		
<p>45mm Adjustable Complete Assembly Struts Includes 2 x Front Strut Assy 2 x Coil Springs 2 x Rear Shocks</p>	<p>\$165 Rear Coils</p> <p>\$185 Rear Coils</p>		

All prices exclude freight. Include only permanent accessories & weights when selecting springs. Towing weight is not included

P: (02) 9672 8899 | F: (02) 9672 8099



NISSAN

TERRANO II

3/97-00

R20



FRONT SUSPENSION

ESTIMATED LIFT: 30mm

PART NO.	QTY	DESCRIPTION	RRP inc GST	NOTES
SHOCK ABSORBERS				
BD2057T	2	35mm Nitro Gas Shock		Up to 30mm Lift
FC42057B	2	41mm Foam Cell Shock		Up to 30mm Lift
TORSION BARS				
4WTB-1458	1	Replacement Torsion Bars		26mm/1232mm
Adjust Torsion bars after fitting shocks - Ensure a minimum of 60mm Droop is Maintained				

REAR SUSPENSION

SHOCK ABSORBERS				
BD1388T	2	35mm Nitro Gas Shock		Up to 30mm Lift
FC41388	2	41mm Foam Cell Shock		Up to 30mm Lift
BM401388	2	40mm 9 Stage Adjustable		Up to 30mm Lift
COIL SPRINGS				
TDC739	2	0-300Kg Load		30mm Lift
TDC739H	2	CONSTANT 300Kg Load		30mm Lift

REPLACEMENT BUSHINGS

QUANTITY PER SHOCK				
TW959	2	Suits Top Front Pin Mount		Pin Style Bushing
412772	1	Suits Bottom Front Eying		Eying Bushing
404702	2	Suits Top & Bottom Rear Eying		Eying Bushing

COMPLETE KIT PRICE REFERENCE

SHOCK CHOICE	SPRING CHOICE	RRP inc GST	CONTENTS
35mm Nitro gas	ANY		
41mm Foam Cell	ANY		
Foam Cell Front Adjustable Rear	ANY		
Includes 2 x Coil Springs 4 x Shocks			

Fitting sheet (located page 208) must be completed when suspension fitted. Failure to comply may affect warranty.



SSANGYONG

MUSSO (INC SPORT UTE)

8/96-07

ALSO SEE DAEWOO

FRONT SUSPENSION

ESTIMATED LIFT: 35mm

PART NO.	QTY	DESCRIPTION	RRP inc GST	NOTES
SHOCK ABSORBERS				
BD2057T	2	35mm Nitrogen Gas Shock		Suits up to 35mm Lift
TORSION BARS				
4WTB-1800	1	Replacement Torsion Bars (Pair)		26mm/1040mm
Adjust Torsion bars after fitting shocks - Ensure a minimum of 60mm Droop is Maintained				

REAR SUSPENSION

SHOCK ABSORBERS				
BD1104T	2	35mm Nitrogen Gas Shock		Suit OE Height
BM401104	2	40mm 9 Stage Adjustable Shock		
BD1105T	2	35mm Nitrogen Gas		Suit 35mm Lift
BM401105	2	40mm 9 Stage Adjustable		
COIL SPRINGS				
TDC100	2	0-300KG Load		35mm Lift
TDC100H	2	CONSTANT 300Kg Load		35mm Lift

REPLACEMENT BUSHINGS

QUANTITY PER SHOCK				
TW959	2	Front Top Pin Mount		Pin Style Bushing
412772	1	Bottom Front Eying		Eying Bushing
TW959	2	Rear Top Pin Mount		Pin Style Bushing
404702	1	Bottom Rear Eying		Eying Bushing

COMPLETE KIT PRICE REFERENCE

SHOCK CHOICE	SPRING CHOICE	RRP inc GST	CONTENTS
35mm Nitrogen Gas	ANY		
Gas Front Adjustable Rear	ANY		
Includes			
4 x Shocks 2 x Coil Springs			

All prices exclude freight. Include only permanent accessories & weights when selecting springs. Towing weight is not included

P: (02) 9672 8899 | F: (02) 9672 8099



SUZUKI

JIMNY

10/98-2018

SN413 (JB33/43/48)



FRONT SUSPENSION

ESTIMATED LIFT: 40-80mm

PART NO.	QTY	DESCRIPTION	RRP inc GST	NOTES
SHOCK ABSORBERS				
BD1133TB	2	35mm Nitro Gas Shock		Suits 40mm Lift ONLY
BD1134TB	2	35mm Nitro Gas Shock		Suits 60 & 80mm Lift
COIL SPRINGS				
TDC836	2	40mm Lift Coil		
TDC838L	2	60mm Lift Coil		Suits 10/98-05 1.3L
TDC824	2	80mm Lift Coil		
TDC824H	2	80mm Lift Coil		Suits with Bar & Winch
TDC838L	2	40mm Lift Coil		
TDC824	2	60mm Lift Coil		Suits 05 On M13A VVT 1.3L
TDC824H	2	80mm Lift Coil		
STEERING STABILIZERS				
SD5610	1	H/Duty Replacement Damper		
SS5610-M/S	1	Return to Centre Damper		Includes Mounting Brackets
SV5610	1	9 Stage Adjustable Damper		Fitting instructions available at toughdog.com.au
CASTER CORRECTION				
TDUK-063	1	3 Degree Caster Correction Bush		1 Kit required per vehicle
PANHARD ROD				
TDPR-009	1	Adjustable Panhard Rod		Suits RHD Vehicles Only
TDPR-011	1	Adjustable Panhard Rod		Suits LHD Vehicles Only
COMPONENTS				
TDUK-039	1	Replacement Trailing Arm Bushes		(0 Degrees Adjustment)
TDSK-022	1	ABS relocation Bracket		Relocation Bracket for ABS Kit fitting instructions at toughdog.com.au

REPLACEMENT BUSHINGS

QUANTITY PER SHOCK				
402267	2	Suits Top Front Pin Mount		Pin Style Bushing
412772	1	Suits Bottom Front Eying		Eying Bushing
412773	1	Suits Top Rear Eying		Eying Bushing
4W-SPF420-02	1	Suits Bottom Rear Eying		Eying Bushing

Fitting sheet (located page 208) must be completed when suspension fitted. Failure to comply may affect warranty.

Note: Castor Correction Bushing kit fitting instructions available at toughdog.com.au

SUZUKI



JIMNY

10/98-2018
SN413 (JB33/43/48)

REAR SUSPENSION

PART NO.	QTY	DESCRIPTION	RRP inc GST	NOTES
SHOCK ABSORBERS				
BD1192TB	2	35mm Nitro Gas Shock		Suits 40mm Lift ONLY
BD1193TB	2	35mm Nitro Gas Shock		Suits 60 & 80mm Lift
COIL SPRINGS				
TDC837	2	40mm Lift Coil		
TDC839L	2	60mm Lift Coil		
TDC825	2	80mm Lift Coil		
TDC826	2	80mm Lift Coil - O/S MODELS		
COMPONENTS				
TDUK-039	1	Replacement Trailing Arm Bushes		
PANHARD ROD				
TDPR-010	1	Adjustable Panhard Rod		
BRAKE HOSE KITS				
TDBH-199	1	Brake Hose Kit 60-80mm		Single Rear Hose (Front not req'd)

COMPLETE KIT PRICE REFERENCE

SHOCK CHOICE	SPRING CHOICE	RRP inc GST	CONTENTS
35mm Nitro Gas	40mm LIFT		
<p>Includes 4 x Coil Springs 4 x Shocks</p>			
35mm Nitro Gas	60 & 80mm LIFT		
<p>Includes 4 x Coil Springs 4 x Shocks 1 x Caster correction kit 2 x Panhard Rods 1 x Brake Hose Kit 1 x ABS Relocation Bracket</p>			

All prices exclude freight. Include only permanent accessories & weights when selecting springs. Towing weight is not included

P: (02) 9672 8899 | F: (02) 9672 8099



SUZUKI

JIMNY
2019 ON
JB74



FRONT SUSPENSION

ESTIMATED LIFT: 40-80mm

PART NO.	QTY	DESCRIPTION	RRP inc GST	NOTES
SHOCK ABSORBERS				
FC31000	2	Foam Cell Shock		Suits 40mm Lift ONLY
FC31001	2	Foam Cell Shock		Suits 60 & 80mm Lift
COIL SPRINGS				
TDC1000	2	40mm Lift Coil		Note: When Bar or Bar & Winch fitted, also fit TDUK-084 spacer listed below
TDC1001	2	60mm Lift Coil		
TDC1002	2	80mm Lift Coil		
STEERING STABILIZERS				
EXT5928	1	H/Duty Replacement Damper		
SS5928-P/S	1	Return to Centre Damper		
SV5928	1	9 Stage Adjustable Damper		
CASTER CORRECTION				
TDUK-063	1	3 Degree Caster Correction Bush		1 kit required with 60 or 80mm lift
PANHARD ROD				
TDPR-021	1	Adjustable Panhard Rod		Suits RHD Vehicles Only
TDPR-023	1	Adjustable Panhard Rod		Suits LHD Vehicles Only
COMPONENTS				
TDUK-039	1	Replacement Trailing Arm Bushes		(0 Degrees Adjustment)
TDSP-016	1	ABS relocation & vacuum hoses		Fit with all kits
TDSP-017	1	Headlight Module Bracket		Fit with all kits
TDSP-018	1	Crossmember Drop Kit		Fit with all kits
TDUK-084	1	Front Coil Spacer (pair of)		Fit with bar or Bar + Winch

REPLACEMENT BUSHINGS

QUANTITY PER SHOCK				
402267	2	Suits Top Front Pin Mount		Pin Style Bushing
412773	1	Suits Bottom Front Eying		Eying Bushing
412773	1	Suits Top Rear Eying		Eying Bushing
412773	1	Suits Bottom Rear Eying		Suits #31002 shock only

Fitting sheet (located page 208) must be completed when suspension fitted. Failure to comply may affect warranty.

Note: Castor Correction Bushing kit fitting instructions available at toughdog.com.au

SUZUKI

JIMNY



2019 ON

JB74

REAR SUSPENSION

PART NO.	QTY	DESCRIPTION	RRP inc GST	NOTES
SHOCK ABSORBERS				
FC31002	2	Foam Cell Shock		Suits 40mm Lift ONLY
FC31003	2	Foam Cell Shock		Suits 60 & 80mm Lift
COIL SPRINGS				
TDC1003	2	40mm Lift Coil		
TDC1004	2	60mm Lift Coil		
TDC1005	2	80mm Lift Coil		
COMPONENTS				
TDUK-039	1	Replacement Trailing Arm Bushes		
PANHARD ROD				
TDPR-010	1	Adjustable Panhard Rod		Fit with 60 & 80mm Lift
BRAKE HOSE KITS				
TDBH-401	1	Rubber Brake Hose Kit		Fit with 60 & 80mm Lift
TDBH-402	1	Braided Brake Hose Kit		Fit with 60 & 80mm Lift
TDBH-403	1	Rubber Brake Hose Kit		Fit with 40mm Lift - Rear L/H Hose

COMPLETE KIT PRICE REFERENCE

SHOCK CHOICE	SPRING CHOICE	RRP inc GST	CONTENTS
Foam Cell	40mm LIFT		
<p>Includes 4 x Coil Springs 4 x Shocks 1 x Headlight Module Kit 1 x Brake hose kit 1 x ABS Relocation Kit 1 x Crossmember Kit</p>			
Foam Cell	60 & 80mm LIFT		
<p>Includes 4 x Coil Springs 4 x Shocks 1 x Castor Correction Kit 2 x Panhard Rods 1 x Brake Hose Kit 1 x Headlight Module Kit 1 x ABS Relocation Kit 1 x Crossmember Kit</p>			

All prices exclude freight. Include only permanent accessories & weights when selecting springs. Towing weight is not included

P: (02) 9672 8899 | F: (02) 9672 8099



SUZUKI

SIERRA

7/74-5/99
LEAF SPRING ONLY



FRONT SUSPENSION

ESTIMATED LIFT: 50mm

PART NO.	QTY	DESCRIPTION	RRP inc GST	NOTES
SHOCK ABSORBERS				
BD1102T	2	35mm Nitro Gas Shock		Suits up to 50mm Lift
LEAF SPRINGS				
T61	2	50mm Lift Lift		Suits All with Bar
STEERING STABILIZERS				
SD14030	1	H/Duty Replacement Damper		
SS5611-M/S	1	Return to Centre Damper		
COMPONENTS				
TDUK-013	1	Urethane Shackle Bushing Kit		
TDUB-014	1	U-Bolt Kit		Passenger Side
TDUB-013	1	U-Bolt Kit		Drivers Side
TDGS-656	1	Greasable Shackle Kit		

REAR SUSPENSION

SHOCK ABSORBERS				
BD1364T	2	35mm Nitro Gas Shock		Suits OE Height
BD1366T	2	35mm Nitro Gas Shock		Suits 50mm Lift
BD1102T	2	35mm Nitro Gas Shock		Suits OE Height LJ80 & 80V
BD1104T	2	35mm Nitro Gas Shock		Suits 50mm Lift LJ80 & 80V
LEAF SPRINGS				
T62	2	50mm Lift		
COMPONENTS				
TDUK-013	1	Urethane Shackle Bushing Kit		
TDUB-014	2	U-Bolt Kit		
TDGS-656	1	Greasable Shackle Kit		

REPLACEMENT BUSHINGS

QUANTITY PER SHOCK				
TW959	2	Suits Top Front Pin Mount		Pin Style Bushing
404702	1	Suits Bottom Front Eying		Eying Bushing
404702	2	Suits Top & Bottom Rear Eying		Eying Bushing

COMPLETE KIT PRICE REFERENCE

SHOCK CHOICE	SPRING CHOICE	RRP inc GST	CONTENTS
35mm Nitro Gas	50mm LIFT		
<p align="center">Includes</p> <p align="center">4 x Leaf Springs 4 x Shocks 4 x U-Bolt Kits 2 x Shackle Bushing Kit</p>			

Fitting sheet (located page 208) must be completed when suspension fitted. Failure to comply may affect warranty.



SUZUKI

VITARA

7/88-06

INCLUDES GRAND VITARA & XL-7

FRONT SUSPENSION

ESTIMATED LIFT: 30mm

PART NO.	QTY	DESCRIPTION	RRP inc GST	NOTES
SHOCK ABSORBERS				
BDS4613	2	Mini Strut Replacement		OE Height
BDS4000LR	2	Mini Strut (Includes Camber Bolt)		30mm Lift
COIL SPRINGS				
TDC814	2	30mm Lift Spring		88-3/98 1.6L SWB
TDC816	2	30mm Lift Spring		88-3/98 2.0L SWB & 1.6L LWB
TDC818	2	30mm Lift Spring		95-3/98 2.0L V6 LWB
TDC834SL	2	30mm Lift Spring		98-05 1.6L, 2.0L SWB & LWB
TDC834	2	30mm Lift Spring		98-05 2.5L V6 LWB
TDC834H	2	30mm Lift Spring		01-06 2.7L V6
STEERING DAMPER				
SS5614-M/S	1	Return to Centre Damper		Manual Steering 7/88-98

REAR SUSPENSION

SHOCK ABSORBERS				
BD1166T	2	35mm Nitro Gas Shock		Up to 30mm Lift
COIL SPRINGS				
TDC815	2	0-300kg Load		30mm Lift 88-3/98 SWB
TDC817	2	0-300kg Load		30mm Lift 91-3/98 LWB
TDC835SL	2	0-300kg Load		30mm Lift 4/98-7/05 SWB
TDC835	2	0-300kg Load		30mm Lift 4/98-7/05 LWB
TDC838	2	0-300kg Load		30mm 7/01-06 XL-7 ONLY
COMPONENTS				
TDPR-024	1	Adjustable Rear Panhard Rod		Suits 4/98-06

REPLACEMENT BUSHINGS

QUANTITY PER SHOCK				
TW959	2	Suits Top Rear Pin Mount		Pin Style Bushing
4W-SPF420-02	1	Suits Rear Bottom Eye		Eye Style Bushing

COMPLETE KIT PRICE REFERENCE

SHOCK CHOICE	SPRING CHOICE	RRP inc GST	CONTENTS
35mm Nitro Gas	30mm LIFT		
<p align="center">Includes 4 x Coil Springs 2 x Rear Shocks 2 x Front Struts</p>			

All prices exclude freight. Include only permanent accessories & weights when selecting springs. Towing weight is not included

P: (02) 9672 8899 | F: (02) 9672 8099



TOYOTA

FORTUNER

04 - 12/15



FRONT SUSPENSION

ESTIMATED LIFT: 40mm

PART NO.	QTY	DESCRIPTION	RRP inc GST	NOTES
SHOCK ABSORBERS				
FC404600	2	40mm Foam Cell Strut		
BM404600	2	40mm Adjustable Strut		9 Stage Adjustable
COIL SPRINGS				
TDC974S	2	OE Height Only		OE Replacement Only
TDC974	2	40mm Lift Spring		Petrol/Diesel/Bar
TDC974H	2	40mm Lift Spring		Petrol/Diesel/Bar/Winch
COMPLETE STRUT ASSEMBLY				
TOY-026/01	2	BM404600/TDC974		Petrol/Diesel/Bar
TOY-026/02	2	BM404600/TDC974H		Petrol/Diesel/Bar/Winch
TOY-026/03	2	FC404600/TDC974		Petrol/Diesel/Bar
TOY-026/04	2	FC404600/TDC974H		Petrol/Diesel/Bar/Winch
REPLACEMENT STRUT ASSEMBLY				
TOY-1083	2	Strut Top		Replacement Strut Top

REAR SUSPENSION

SHOCK ABSORBERS				
FC41113	2	41mm Foam Cell Shock		Up to 40mm Lift
BM401113	2	40mm 9 Stage Adjustable		Up to 40mm Lift
COIL SPRINGS				
TDC912	2	0-300kg Load		40mm Lift
TDC912L	2	CONSTANT 300Kg Load		40mm Lift
TDC912HL	2	CONSTANT 500Kg Load		40mm Lift

REPLACEMENT BUSHINGS

QUANTITY PER SHOCK				
TOY-1083	1	Replacement Strut Top		Available As Complete Unit Only
ADJ300/40	1	Suits Bottom Front Eying		Eying Bonded Bushing
ADJ00191	1	Suits Rear Bottom Eying		Eying Bushing
TW959	2	Suits Rear Top Pin		Pin Style Bushing





Fitting sheet (located page 208) must be completed when suspension fitted. Failure to comply may affect warranty.

TOYOTA

FORTUNER

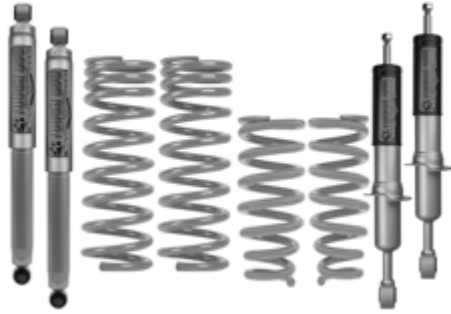
04 - 12/15
All Models

COMPLETE KIT PRICE REFERENCE

SHOCK CHOICE	SPRING CHOICE	RRP inc GST	CONTENTS
<p>Foam Cell Struts Require Assembly</p> <p><u>Includes</u> 2x Front Struts 2x Rear Shocks 4x Coil Springs</p>	ANY		
<p>Foam Cell Complete Assembly Struts</p> <p><u>Includes</u> 2x Complete Struts 2x Rear Shocks 2x Coil Springs</p>	ANY		
<p>40mm Adjustable Struts Require Assembly</p> <p><u>Includes</u> 2x Front Struts 2x Rear Shocks 4x Coil Springs</p>	ANY		
<p>40mm Adjustable Complete Assembly Struts</p> <p><u>Includes</u> 2x Complete Struts 2x Rear Shocks 2x Coil Springs</p>	ANY		

All prices exclude freight. Include only permanent accessories & weights when selecting springs. Towing weight is not included

TOYOTA

FORTUNER

15 On
GUN156



FRONT SUSPENSION

ESTIMATED LIFT: 40mm

PART NO.	QTY	DESCRIPTION	RRP inc GST	NOTES
SHOCK ABSORBERS				
FC404600	2	40mm Foam Cell Strut		
BM404600	2	40mm Adjustable Strut		9 Stage Adjustable
COIL SPRINGS				
TDC974	2	40mm Lift Spring		Petrol/Diesel/No Bar
TDC983	2	40mm Lift Spring		Petrol/Diesel/Bar
TDC974H	2	40mm Lift Spring		Petrol/Diesel/Bar/Winch
COMPLETE STRUT ASSEMBLY				
TOY-026/01	2	BM404600/TDC974		Petrol/Diesel/No Bar
TOY-027/02	2	BM404600/TDC983		Petrol/Diesel/Bar
TOY-027/03	2	BM404600/TDC974H		Petrol/Diesel/Bar/Winch
TOY-026/03	2	FC404600/TDC974		Petrol/Diesel/No Bar
TOY-027/06	2	FC404600/TDC983		Petrol/Diesel/Bar
TOY-027/07	2	FC404600/TDC974H		Petrol/Diesel/Bar/Winch
ADDITIONAL COMPONENTS				
TOY-1083	2	Strut Top		Replacement Strut Top
TDCA-002	1	Upper Control Arms (pair)		Suits up to 75mm Lift

REAR SUSPENSION

SHOCK ABSORBERS				
FC43016	2	41mm Foam Cell Shock		Up to 40mm Lift
BM403016	2	40mm 9 Stage Adjustable		Up to 40mm Lift
COIL SPRINGS				
TDC913L	2	0-300kg Load		40mm Lift
TDC913HL	2	CONSTANT 300Kg Load		40mm Lift
TDC913VHL	2	CONSTANT 500Kg Load		40mm Lift
COMPONENTS				
TDSP-010	1	Transmission Spacer Kit		Must be fitted with all lift kits
TDPR-020	1	Adjustable Panhard Rod		
AIR ASSIST BAGS				
TDAA-003	1	Coil insert bag kit		Suits 40mm Lift
TDAA-019	1	Coil insert bag kit		Suits standard height ONLY

REPLACEMENT BUSHINGS

QUANTITY PER SHOCK				
TOY-1083	1	Replacement Strut Top		Available As Complete Unit Only
ADJ300/40	1	Suits Bottom Front Eying		Eying Bonded Bushing
415024	1	Suits Rear Bottom Eying		Eying Bushing





Fitting sheet (located page 208) must be completed when suspension fitted. Failure to comply may affect warranty.

TOYOTA

FORTUNER

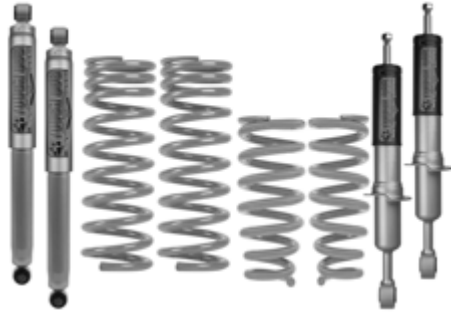
15 On
GUN156

COMPLETE KIT PRICE REFERENCE

SHOCK CHOICE	SPRING CHOICE	RRP inc GST	CONTENTS
<p>Foam Cell Struts Require Assembly</p> <p><u>Includes</u> 2x Front Struts 2x Rear Shocks 4x Coil Springs 1x Transmission Spacer</p>	ANY		
<p>Foam Cell Complete Assembly Struts</p> <p><u>Includes</u> 2x Complete Struts 2x Rear Shocks 2x Coil Springs 1x Transmission Spacer</p>	ANY		
<p>40mm Adjustable Struts Require Assembly</p> <p><u>Includes</u> 2x Front Struts 2x Rear Shocks 4x Coil Springs 1x Transmission Spacer</p>	ANY		
<p>40mm Adjustable Complete Assembly Struts</p> <p><u>Includes</u> 2x Complete Struts 2x Rear Shocks 2x Coil Springs 1x Transmission Spacer</p>	ANY		

All prices exclude freight. Include only permanent accessories & weights when selecting springs. Towing weight is not included

TOYOTA

4RUNNER

11/85-89

IFS WITH LEAF REAR



FRONT SUSPENSION

ESTIMATED LIFT: 50mm

PART NO.	QTY	DESCRIPTION	RRP inc GST	NOTES
SHOCK ABSORBERS				
FC41127B	2	35mm Foam Cell Shock		Up to 50mm Lift
TORSION BARS				
4WTB-1646	1	Replacement Torsion Bars		26mm/1064mm
Adjust Torsion bars after fitting shocks - Ensure a minimum of 60mm Droop is Maintained				
STEERING DAMPERS				
EXT5510	1	H/D Replacement Damper		
S55510-P/S	1	Return to Centre Damper		

REAR SUSPENSION

SHOCK ABSORBERS				
BD1350T	2	35mm Nitro Gas Shock		Suits OE Height
FC41350	2	41mm Foam Cell Shock		
BM401350	2	40mm 9 Stage Adjustable		
BD1377T	2	35mm Nitro Gas Shock		Suits 50mm Lift
FC41377	2	41mm Foam Cell Shock		
BM401377	2	40mm 9 Stage Adjustable		
LEAF SPRINGS				
T46C	2	0-300kg Load		50mm Lift
T46L	2	CONSTANT 300Kg Load		50mm Lift
COMPONENTS				
TDUK-015	1	Urethane Shackle Bushing Kit		
TDUB-016	2	U-Bolt Kit		
TDGP-385	1	Greasable Pin Kit		
TDGS-386	1	Greasable Shackle Kit		

REPLACEMENT BUSHINGS

QUANTITY PER SHOCK				
TW959	1	Suits Front Top Pin		Pin Style Bushing
ADJ00191	1	Suits Top & Bottom Rear Eye		Eyering Bushing
TW038-16	1	Suits Front Bottom Eye		Eyering Bushing

COMPLETE KIT PRICE REFERENCE

SHOCK CHOICE	SPRING CHOICE	RRP inc GST	CONTENTS
Foam Cell Front Nitro Gas Rear	T46C 0-300KG T46L 300KG+		
41mm Foam Cell	T46C 0-300KG T46L 300KG+		
Foam Cell Front Adjustable Rear	T46C 0-300KG T46L 300KG+		

Fitting sheet (located page 208) must be completed when suspension fitted. Failure to comply may affect warranty.



TOYOTA

4RUNNER

89-96

IFS WITH COIL REAR

FRONT SUSPENSION

ESTIMATED LIFT: 50mm

PART NO.	QTY	DESCRIPTION	RRP inc GST	NOTES
SHOCK ABSORBERS				
FC41127B	2	35mm Foam Cell Shock		Up to 50mm Lift
TORSION BARS				
4WTB-1646	1	Replacement Torsion Bars		26mm/1064mm
Adjust Torsion bars after fitting shocks - Ensure a minimum of 60mm Droop is Maintained				
STEERING DAMPERS				
EXT5510	1	H/D Replacement Damper		
S55510-P/S	1	Return to Centre Damper		

REAR SUSPENSION

SHOCK ABSORBERS				
FC41108	2	41mm Foam Cell Shock		Suits OE Height
BM401108	2	40mm 9 Stage Adjustable		
FC41113	2	41mm Foam Cell Shock		Suits 50mm Lift
BM401113	2	40mm 9 Stage Adjustable		
COIL SPRINGS				
TDC946S	2	0-300kg Load		OE Height
TDC946	2	0-300kg Load		50mm Lift
TDC946H	2	CONSTANT 300Kg Load		50mm Lift
PANHARD ROD				
TDPR-008	1	Adjustable Panhard Rod		

REPLACEMENT BUSHINGS

QUANTITY PER SHOCK				
TW959	2	Suits Front Top Pin		Pin Style Bushing
TW959	2	Suits Rear Top Pin		Pin Style Bushing
ADJ00191	1	Suits Bottom Rear Eye		Eyering Bushing
TW038-16	1	Suits Front Bottom Eyering		Eyering Bushing

COMPLETE KIT PRICE REFERENCE

SHOCK CHOICE	SPRING CHOICE	RRP inc GST	CONTENTS
41mm Foam Cell	ANY REAR COIL		
Foam Cell Front Adjustable Rear	ANY REAR COIL		
Includes 2 x Coil Springs 4 x Shocks			

All prices exclude freight. Include only permanent accessories & weights when selecting springs. Towing weight is not included

P: (02) 9672 8899 | F: (02) 9672 8099



TOYOTA

HILUX

4/79-97

LEAF/LEAF 4WD



FRONT SUSPENSION

ESTIMATED LIFT: 50mm

PART NO.	QTY	DESCRIPTION	RRP inc GST	NOTES
SHOCK ABSORBERS				
BD1134T	2	35mm Nitrogen Gas Shock		Suit OE Height
FC41134	2	41mm Foam Cell Shock		
BM401134	2	40mm 9 Stage Adjustable Shock		
BD1109T	2	35mm Nitrogen Gas		Suit 50mm Lift
FC41109	2	41mm Foam Cell Shock		
BM401109	2	40mm 9 Stage Adjustable		
LEAF SPRINGS				
T75	2	Petrol/Diesel/Bar		50mm Lift Spring
T78	2	Petrol/Diesel/Bar/Winch		50mm Lift Spring
STEERING DAMPERS				
EXT5500	1	H/D Replacement Damper		Suits Manual Steering Suits Power Steering
SS5500-M/S	1	Return to Centre Damper		
SS5500-P/S	1	Return to Centre Damper		
SV5500	1	9 Stage Adjustable Damper		
COMPONENTS				
TDUK-014	1	Urethane Shackle Bushing Kit		Suits D/S (1 Kit Req'd) Suits P/S (1 Kit Req'd) Fit with all Lift Kits
TDUB-015	1	U-Bolt Kit		
TDUB-016	1	U-Bolt Kit		
TDGP-385	1	Greasable Pin Kit		
TDGS-384	1	Greasable Shackle Kit		
TDDL-001	1	Adjustable Diff Locator		

FRONT END KIT PRICE REFERENCE

SHOCK CHOICE	SPRING CHOICE	RRP inc GST	CONTENTS
35mm Nitro Gas	T75		
	T78		
41mm Foam Cell	T75		
	T78		
9 Stage Adjustable	T75		
	T78		
<p align="center">Includes</p> <p align="center">2 x Leaf Springs 2 x Shocks 2 x U-Bolt Kits 1 x Urethane Kit 1 x Diff Locator</p>			

Fitting sheet (located page 208) must be completed when suspension fitted. Failure to comply may affect warranty.

TOYOTA

HILUX

4/79-97

LEAF/LEAF 4WD

REAR SUSPENSION

PART NO.	QTY	DESCRIPTION	RRP inc GST	NOTES
SHOCK ABSORBERS				
BD1382T	2	35mm Nitrogen Gas Shock		Suits OE Height 4/79-83 Models
FC41382	2	41mm Foam Cell Shocks		
BM401382	2	40mm 9 Stage Adjustable Shock		
BD1388T	2	35mm Nitrogen Gas		Suits 50mm Lift 4/79-83 Models
FC41388	2	41mm Foam Cell Shocks		
BM401388	2	40mm 9 Stage Adjustable		
BD1350T	2	35mm Nitrogen Gas		Suits OE Height 11/83-97 Models
FC41350	2	41mm Foam Cell Shocks		
BM401350	2	40mm 9 Stage Adjustable		
BD1377T	2	35mm Nitrogen Gas		Suits 50mm Lift 11/83-97 Models
FC41377	2	41mm Foam Cell Shocks		
BM401377	2	40mm 9 Stage Adjustable		
LEAF SPRINGS				
T46C	2	0-300Kg Load		50mm Lift Spring
T46L	2	CONSTANT 300Kg Load		50mm Lift Spring
BP-002XHD	2	CONSTANT 500Kg Load		50mm Lift Spring
COMPONENTS				
TDUK-015	1	Urethane Shackle Bushing Kit		
TDUB-016	2	U-Bolt Kit		
TDGP-385	1	Greasable Pin Kit		
TDGS-386	1	Greasable Shackle Kit		

REAR END KIT PRICE REFERENCE

SHOCK CHOICE	SPRING CHOICE	RRP inc GST	CONTENTS
35mm Nitro Gas	T46C T46L BP-002XHD		
41mm Foam Cell	T46C T46L BP-002XHD		
9 Stage Adjustable	T46C T46L BP-002XHD		
Includes 2 x Leaf Springs 2 x Shocks 2 x U-Bolt Kits 1 x Urethane Kit			

All prices exclude freight. Include only permanent accessories & weights when selecting springs. Towing weight is not included

P: (02) 9672 8899 | F: (02) 9672 8099



TOYOTA

HILUX

10/88-97

TORSION BAR FRONT



FRONT SUSPENSION

ESTIMATED LIFT: 50mm

PART NO.	QTY	DESCRIPTION	RRP inc GST	NOTES
SHOCK ABSORBERS				
FC41127B	2	35mm Foam Cell Shock		Up to 50mm Lift
TORSION BARS				
4WTB-1646	1	Replacement Torsion Bars		26mm/1064mm
Adjust Torsion bars after fitting shocks - Ensure a minimum of 60mm Droop is Maintained				
STEERING DAMPERS				
EXT5510	1	H/D Replacement Damper		
SS5510-P/S	1	Return to Centre Damper		

REAR SUSPENSION

SHOCK ABSORBERS				
BD1350T	2	35mm Nitro Gas Shock		Suits OE Height
FC41350	2	41mm Foam Cell Shock		
BM401350	2	40mm 9 Stage Adjustable		
BD1377T	2	35mm Nitro Gas Shock		Suits 50mm Lift
FC41377	2	41mm Foam Cell Shock		
BM401377	2	40mm 9 Stage Adjustable		
LEAF SPRINGS				
BP-007	2	0-300kg Load		50mm Lift
BP-007H	2	CONSTANT 300Kg Load		50mm Lift
BP-007HH	2	CONSTANT 500Kg Load		50mm Lift
COMPONENTS				
TDUK-065	1	Urethane Shackle Bushing Kit		
TDUB-016	2	U-Bolt Kit		
TDGS-386/1	1	Greasable Shackle Kit		
TDGP-668	1	Greasable Pin Kit		

REPLACEMENT BUSHINGS

QUANTITY PER SHOCK				
TW959	2	Suits Front Top Pin		Pin Style Bushing
TW038-16	1	Suits Front Bottom Eye		Eyering Bushing
ADJ00191	2	Suits Top & Bottom Rear Eye		Eyering Bushing

Fitting sheet (located page 208) must be completed when suspension fitted. Failure to comply may affect warranty.



TOYOTA

HILUX

10/88-97

TORSION BAR FRONT

COMPLETE KIT PRICE REFERENCE

SHOCK CHOICE	SPRING CHOICE	RRP inc GST	CONTENTS
<p>Foam Cell Front Nitro gas Rear</p> <p><u>Includes</u> 2 x Leaf Springs 4 x Shocks 2 x U-Bolt Kits 1 x Urethane Kit</p>	<p>BP-007 0-300KG</p> <p>BP-007H CONSTANT 300KG</p> <p>BP-007HH CONSTANT 500KG</p>		
<p>41mm Foam Cell</p> <p><u>Includes</u> 2 x Leaf Springs 4 x Shocks 2 x U-Bolt Kits 1 x Urethane Kit</p>	<p>BP-007 0-300KG</p> <p>BP-007H CONSTANT 300KG</p> <p>BP-007HH CONSTANT 500KG</p>		
<p>Foam Cell Front Adjustable Rear</p> <p><u>Includes</u> 2 x Leaf Springs 4 x Shocks 2 x U-Bolt Kits 1 x Urethane Kit</p>	<p>BP-007 0-300KG</p> <p>BP-007H CONSTANT 300KG</p> <p>BP-007HH CONSTANT 500KG</p>		

All prices exclude freight. Include only permanent accessories & weights when selecting springs. Towing weight is not included

P: (02) 9672 8899 | F: (02) 9672 8099



TOYOTA

HILUX

10/97-05

TORSION BAR FRONT



FRONT SUSPENSION

ESTIMATED LIFT: 50mm

PART NO.	QTY	DESCRIPTION	RRP inc GST	NOTES
SHOCK ABSORBERS				
FC41127B	2	41mm Foam Cell Shock		Up to 50mm Lift
TORSION BARS				
4WTB-1646	1	Replacement Torsion Bars		26mm/1064mm
Adjust Torsion bars after fitting shocks - Ensure a minimum of 60mm Droop is Maintained				
STEERING DAMPERS				
EXT5510	1	H/D Replacement Damper		
SS5513-P/S	1	Return to Centre Damper		
SV5513	1	9 Stage Adjustable Damper		

REAR SUSPENSION

SHOCK ABSORBERS				
Please take note of shock application for standard and lifted height vehicles				
BD1350T (D/S)	1	35mm Nitro Gas Shock		Suits OE Height
BD1377T (P/S)	1	35mm Nitro Gas Shock		
FC41350 (D/S)	1	41mm Foam Cell Shock		
FC41377 (P/S)	1	41mm Foam Cell Shock		
BM401350 (D/S)	1	40mm 9 Stage Adjustable		
BM401377 (P/S)	1	40mm 9 Stage Adjustable		
BD1377T	2	35mm Nitro Gas Shock		Suits 50mm Lift
FC41377	2	41mm Foam Cell Shock		
BM401377	2	40mm 9 Stage Adjustable		
LEAF SPRINGS				
T79C	2	0-300kg Load		50mm Lift
T79L	2	CONSTANT 300Kg Load		50mm Lift
T79LL	2	CONSTANT 500Kg Load		50mm Lift
COMPONENTS				
TDUK-038	1	Urethane Shackle Bushing Kit		
TDUB-016	2	U-Bolt Kit		
TDGS-386/1	1	Greasable Shackle Kit		
TDGP-668	1	Greasable Pin Kit		

REPLACEMENT BUSHINGS

QUANTITY PER SHOCK				
TW959	2	Suits Front Top Pin		Pin Style Bushing
ADJ00191	2	Suits Top & Bottom Rear Eye		Eyering Bushing
TW038-16	1	Suits Front Bottom Eye		Eyering Bushing

Fitting sheet (located page 208) must be completed when suspension fitted. Failure to comply may affect warranty.



TOYOTA

HILUX

10/97-05

TORSION BAR FRONT

COMPLETE KIT PRICE REFERENCE

SHOCK CHOICE	SPRING CHOICE	RRP inc GST	CONTENTS
<p>Foam Cell Front Nitro gas Rear</p> <p><u>Includes</u> 2 x Leaf Springs 4 x Shocks 2 x U-Bolt Kits 1 x Urethane Kit</p>	<p>T79C 0-300KG</p> <p>T79L CONSTANT 300KG</p> <p>T79LL CONSTANT 500KG</p>		
<p>41mm Foam Cell</p> <p><u>Includes</u> 2 x Leaf Springs 4 x Shocks 2 x U-Bolt Kits 1 x Urethane Kit</p>	<p>T79C 0-300KG</p> <p>T79L CONSTANT 300KG</p> <p>T79LL CONSTANT 500KG</p>		
<p>Foam Cell Front Adjustable Rear</p> <p><u>Includes</u> 2 x Leaf Springs 4 x Shocks 2 x U-Bolt Kits 1 x Urethane Kit</p>	<p>T79C 0-300KG</p> <p>T79L CONSTANT 300KG</p> <p>T79LL CONSTANT 500KG</p>		

All prices exclude freight. Include only permanent accessories & weights when selecting springs. Towing weight is not included

P: (02) 9672 8899 | F: (02) 9672 8099



TOYOTA

HILUX

4/05-15

KUN26R GGN25R (COIL/LEAF)



FRONT SUSPENSION

ESTIMATED LIFT: 40mm

PART NO.	QTY	DESCRIPTION	RRP inc GST	NOTES
SHOCK ABSORBERS				
FC404600	2	40mm Foam Cell Strut		
BM404600	2	40mm Adjustable Strut		9 Stage Adjustable
COIL SPRINGS				
TDC974S	2	OE Height Only		OE Replacement Only
TDC974	2	40mm Lift Spring		Petrol/Diesel/Bar
TDC974H	2	40mm Lift Spring		Petrol/Diesel/Bar/Winch
COMPLETE STRUT ASSEMBLY				
TOY-026/01	2	BM404600/TDC974		Petrol/Diesel/Bar
TOY-026/02	2	BM404600/TDC974H		Petrol/Diesel/Bar/Winch
TOY-026/03	2	FC404600/TDC974		Petrol/Diesel/Bar
TOY-026/04	2	FC404600/TDC974H		Petrol/Diesel/Bar/Winch
ADDITIONAL COMPONENTS				
TOY-1083	2	Strut Top		Replacement Strut Top
TDSP-011	1	Sway Bar Spacer Kit		76mm hole spacing
TDCA-002	1	Upper Control Arms (pair)		Suits up to 75mm Lift

REAR SUSPENSION

SHOCK ABSORBERS				
FC41350	2	41mm Foam Cell Shock		SUITS OE HEIGHT ONLY!!
BM401350	2	40mm Adjustable Shock		
FC41376	2	41mm Foam Cell Shock		SUITS 40MM LIFT ONLY!!
BM401376	2	40mm Adjustable Shock		
LEAF SPRINGS				
T80C	2	0-300KG Load		40mm Lift
T80L	2	CONSTANT 300Kg Load		40mm Lift
T80LL	2	CONSTANT 500Kg Load		40mm Lift
FIT CONSTANT LEAVES ONLY WHERE CONSTANT LOAD FITTED - PREMATURE FAILURE MAY OCCUR				
COMPONENTS				
TDUK-067	1	Urethane Bushing Kit		
TDUB-016	2	U-Bolt Kit		
TDGS-389	1	Greasable Shackle Kit		
TDGP-668	1	Greasable Pin Kit		
AIR ASSIST BAGS				
TDAA-112	1	Bellows bag kit		Suits 40mm Lift
TDAA-123	1	Bellows bag kit		Suits standard height ONLY
REPLACEMENT BUSHES (QUANTITY PER BUSH)				
TOY-1083	1	Top Front Replacement Assembly		Bushes not sold separately
ADJ300/40	1	Bottom Front Eying		Bonded eyering bushing
ADJ00191	2	Top & Bottom Rear Eying		Eyering Bushing

Fitting sheet (located page 208) must be completed when suspension fitted. Failure to comply may affect warranty.

TOYOTA

HILUX

4/05-15

KUN26R GGN25R (COIL/LEAF)

COMPLETE KIT PRICE REFERENCE

SHOCK CHOICE	SPRING CHOICE	RRP inc GST	CONTENTS
<p>Foam Cell Struts Require Assembly</p> <p><u>Includes</u> 2 x Coil Springs 4 x Shocks 2 x Leaf Springs 2 x U-Bolt Kits 1 x Urethane Kit</p>	<p>T80C 0-300KG</p> <p>T80L CONSTANT 300KG</p> <p>T80LL CONSTANT 500KG</p>		
<p>Foam Cell Complete Assembly Struts</p> <p><u>Includes</u> 2 x Complete Struts 2 x Shocks 2 x Leaf Springs 2 x U-Bolt Kits 1 x Urethane Kit</p>	<p>T80C 0-300KG</p> <p>T80L CONSTANT 300KG</p> <p>T80LL CONSTANT 500KG</p>		
<p>40mm Adjustable Struts Require Assembly</p> <p><u>Includes</u> 2 x Coil Springs 4 x Shocks 2 x Leaf Springs 2 x U-Bolt Kits 1 x Urethane Kit</p>	<p>T80C 0-300KG</p> <p>T80L CONSTANT 300KG</p> <p>T80LL CONSTANT 500KG</p>		
<p>40mm Adjustable Complete Assembly Struts</p> <p><u>Includes</u> 2 x Complete Struts 2 x Shocks 2 x Leaf Springs 2 x U-Bolt Kits 1 x Urethane Kit</p>	<p>T80C 0-300KG</p> <p>T80L CONSTANT 300KG</p> <p>T80LL CONSTANT 500KG</p>		

All prices exclude freight. Include only permanent accessories & weights when selecting springs. Towing weight is not included

P: (02) 9672 8899 | F: (02) 9672 8099



TOYOTA

HILUX

10/15 On

GUN125R, 126R GGN125R (COIL/LEAF)



FRONT SUSPENSION

ESTIMATED LIFT: 40mm

PART NO.	QTY	DESCRIPTION	RRP inc GST	NOTES
SHOCK ABSORBERS				
FC404600	2	40mm Foam Cell Strut		
BM404600	2	40mm Adjustable Strut		9 Stage Adjustable
COIL SPRINGS				
TDC983S	2	OE Height Only		OE Replacement Only
TDC983	2	40mm Lift Spring		Petrol/Diesel/No bar
TDC974H	2	40mm Lift Spring		Petrol/Diesel/Bar
TDC974HH	2	40mm Lift Spring		Petrol/Diesel/Bar/Winch
COMPLETE STRUT ASSEMBLY				
TOY-027/01	2	BM404600/TDC983S		OE Replacement Only
TOY-027/02	2	BM404600/TDC983		Petrol/Diesel/No bar
TOY-027/03	2	BM404600/TDC974H		Petrol/Diesel/Bar
TOY-027/04	2	BM404600/TDC974HH		Petrol/Diesel/Bar/Winch
TOY-027/05	2	FC404600/TDC983S		OE Replacement Only
TOY-027/06	2	FC404600/TDC983		Petrol/Diesel/No bar
TOY-027/07	2	FC404600/TDC974H		Petrol/Diesel/Bar
TOY-027/08	2	FC404600/TDC974HH		Petrol/Diesel/Bar/Winch
ADDITIONAL COMPONENTS				
TOY-1083	2	Strut Top		Replacement Strut Top
TDCA-002	1	Upper Control Arms (pair)		Suits up to 75mm Lift

REAR SUSPENSION

SHOCK ABSORBERS				
FC43014	2	41mm Foam Cell Shock		Suit OE Height
BM403014	2	40mm Adjustable Shock		
BD3015T	2	35mm Nitro Gas Shock		Fit for Comfort Applications
FC43015	2	41mm Foam Cell Shock		Suit 40mm Lift
BM403015	2	40mm Adjustable Shock		
LEAF SPRINGS - FIT CONSTANT LEAVES ONLY FOR CONSTANT LOAD FITTED - FAILURE MAY OCCUR				
T81C	2	0-300KG Load		40mm Lift
T81L	2	CONSTANT 300Kg Load		40mm Lift
T81LL	2	CONSTANT 500Kg Load		40mm Lift
COMPONENTS				
TDUK-067	1	Urethane Bushing Kit		
TDUB-016	2	U-Bolt Kit		
TDGS-392	1	Greasable Shackle Kit		
TDGP-668	1	Greasable Pin Kit		
TDSP-010	1	Driveshaft spacer kit		For use if vibration occurs
AIR ASSIST BAGS				
TDAA-113	1	Bellows bag kit		Suits 40mm Lift
TDAA-122	1	Bellows bag kit		Suits standard height ONLY

Replacement Bushings - see p148

Fitting sheet (located page 208) must be completed when suspension fitted. Failure to comply may affect warranty.

Note: Leaf spring front eye bolt & Headlight leveling sensor fitting instructions available at toughdog.com.au

COMPLETE KIT PRICE REFERENCE

SHOCK CHOICE	SPRING CHOICE	RRP inc GST	CONTENTS
<p>Foam Cell Struts Require Assembly</p> <p><u>Includes</u> 2 x Coil Springs 4 x Shocks 2 x Leaf Springs 2 x U-Bolt Kits 1 x Urethane Kit</p>	<p>T81C 0-300KG</p> <p>T81L CONSTANT 300KG</p> <p>T81LL CONSTANT 500KG</p>		
<p>Foam Cell Complete Assembly Struts</p> <p><u>Includes</u> 2 x Complete Struts 2 x Shocks 2 x Leaf Springs 2 x U-Bolt Kits 1 x Urethane Kit</p>	<p>T81C 0-300KG</p> <p>T81L CONSTANT 300KG</p> <p>T81LL CONSTANT 500KG</p>		
<p>40mm Adjustable Struts Require Assembly</p> <p><u>Includes</u> 2 x Coil Springs 4 x Shocks 2 x Leaf Springs 2 x U-Bolt Kits 1 x Urethane Kit</p>	<p>T81C 0-300KG</p> <p>T81L CONSTANT 300KG</p> <p>T81LL CONSTANT 500KG</p>		
<p>40mm Adjustable Complete Assembly Struts</p> <p><u>Includes</u> 2 x Complete Struts 2 x Shocks 2 x Leaf Springs 2 x U-Bolt Kits 1 x Urethane Kit</p>	<p>T81C 0-300KG</p> <p>T81L CONSTANT 300KG</p> <p>T81LL CONSTANT 500KG</p>		

All prices exclude freight. Include only permanent accessories & weights when selecting springs. Towing weight is not included

TOYOTA

LANDCRUISER

12/77-84
40, 42 SERIES



FRONT SUSPENSION

ESTIMATED LIFT: 50mm

PART NO.	QTY	DESCRIPTION	RRP inc GST	NOTES
SHOCK ABSORBERS				
FC41364	2	41mm Foam Cell Shocks		Suit OE Height
BM401364	2	40mm 9 Stage Adjustable Shock		
FC41366	2	41mm Foam Cell Shocks		Suit 50mm Lift
BM401366	2	40mm 9 Stage Adjustable		
LEAF SPRINGS - Check Eye Size Prior to Ordering				
BP-009	2	50mm Lift Spring - 25mm Eying		Petrol/Diesel/Bar
BP-009H	2	50mm Lift Spring - 25mm Eying		Petrol/Diesel/Bar/Winch
BP-011	2	50mm Lift Spring - 35mm Eying		Petrol/Diesel/Bar
BP-011H	2	50mm Lift Spring - 35mm Eying		Petrol/Diesel/Bar/Winch
STEERING STABILIZERS				
EXT5511	1	H/Duty Replacement Damper		
SS5511-M/S	1	Return to Centre Damper		Suits Manual Steering
SS5511-P/S	1	Return to Centre Damper		Suits Power Steering
COMPONENTS				
TDUK-016	1	Urethane Shackle Bushing Kit		Suits 25mm Eye Springs
TDUK-012	1	Urethane Shackle Bushing Kit		Suits 35mm Eye Springs
TDUB-017	2	U-Bolt Kit		
TDGP-346	1	Greasable pins		Suits 25mm Eye Springs
TDGS-343	1	Greasable Shackles		Suits 25mm Eye Springs
TDGP-351	1	Greasable pins		Suits 35mm Eye Springs
TDGS-348	1	Greasable Shackles		Suits 35mm Eye Springs

REPLACEMENT BUSHINGS

QUANTITY PER SHOCK				
404702	2	Suits Front Top & bottom Eye		Eying Bushing
404702	2	Suits Rear Top & bottom Eye		Eying Bushing

Fitting sheet (located page 208) must be completed when suspension fitted. Failure to comply may affect warranty.



**KIT PRICING REFERENCE
COMPONENTS AS PER IMAGE**
please order using part numbers

TOYOTA
LANDCRUISER
12/77-84
40, 42 SERIES

REAR SUSPENSION

PART NO.	QTY	DESCRIPTION	RRP inc GST	NOTES
SHOCK ABSORBERS				
FC41366	2	41mm Foam Cell Shocks		Suit OE Height FJ40 59-84 To Chassis # 191114
BM401366	2	40mm 9 Stage Adjustable Shock		
FC41382	2	41mm Foam Cell Shocks		Suit 50mm Lift FJ40 59-84 To Chassis # 191114
BM401382	2	40mm 9 Stage Adjustable		
FC41382	2	41mm Foam Cell Shocks		Suit OE Height BJ40 12/77-80 & BJ42 - Chassis 191115 On
BM401382	2	40mm 9 Stage Adjustable Shock		
FC41388	2	41mm Foam Cell Shocks		Suit 50mm Lift BJ40 12/77-80 & BJ42 - Chassis 191115 On
BM401388	2	40mm 9 Stage Adjustable		
LEAF SPRINGS - Check Eye Size Prior to Ordering				
BP-010	2	50mm Lift Spring - 25mm Eying		0-300kg Load
BP-010H	2	50mm Lift Spring - 25mm Eying		CONSTANT 300Kg Load
BP-012	2	50mm Lift Spring - 35mm Eying		0-300kg Load
BP-012H	2	50mm Lift Spring - 35mm Eying		CONSTANT 300Kg Load
COMPONENTS				
TDUK-016	1	Urethane Shackle Bushing Kit		Suits 25mm Eye Springs
TDUK-012	1	Urethane Shackle Bushing Kit		Suits 35mm Eye Springs
TDUB-017	2	U-Bolt Kit		
TDGP-346	1	Greasable pins		Suits 25mm Eye Springs
TDGS-343	1	Greasable Shackles		Suits 25mm Eye Springs
TDGP-351	1	Greasable pins		Suits 35mm Eye Springs
TDGS-348	1	Greasable Shackles		Suits 35mm Eye Springs

COMPLETE KIT PRICE REFERENCE

SHOCK CHOICE	SPRING CHOICE	RRP inc GST	CONTENTS
41mm Foam Cell	BP-009 + BP-010		
	BP-009H+BP-010H		
	BP-011+BP012		
	BP-011H+BP-012H		
40mm 9 Stage Adjustable	BP-009 + BP-010		
	BP-009H+BP-010H		
	BP-011+BP012		
	BP-011H+BP-012H		
Includes 4 x Leaf Springs 4 x Shocks 2 x Urethane Kits 4 x U-Bolt Kits			
Please Check Eye Size Prior to Ordering No Exchange for Special Order Parts			

All prices exclude freight. Include only permanent accessories & weights when selecting springs. Towing weight is not included

TOYOTA

LANDCRUISER

1/65-84
45, 47 SERIES



FRONT SUSPENSION

ESTIMATED LIFT: 50mm

PART NO.	QTY	DESCRIPTION	RRP inc GST	NOTES
SHOCK ABSORBERS				
FC41364	2	41mm Foam Cell Shocks		Suit OE Height
BM401364	2	40mm 9 Stage Adjustable Shock		
FC41366	2	41mm Foam Cell Shocks		Suit 50mm Lift
BM401366	2	40mm 9 Stage Adjustable		
LEAF SPRINGS - Check Eye Size Prior to Ordering				
BP-013 (45 SERIES)	2	50mm Lift Spring - 25mm Eying		Petrol/Diesel/Bar
BP-013H (45 SERIES)	2	50mm Lift Spring - 25mm Eying		Petrol/Diesel/Bar/Winch
BP-015 (47 SERIES)	2	50mm Lift Spring - 35mm Eying		Petrol/Diesel/Bar
BP-015H (47 SERIES)	2	50mm Lift Spring - 35mm Eying		Petrol/Diesel/Bar/Winch
STEERING STABILIZERS				
EXT5511	1	H/Duty Replacement Damper		
SS5511-M/S	1	Return to Centre Damper		Suits Manual Steering
SS5511-P/S	1	Return to Centre Damper		Suits Power Steering
COMPONENTS				
TDUK-016	1	Urethane Shackle Bushing Kit		Suits 25mm Eye Springs
TDUK-012	1	Urethane Shackle Bushing Kit		Suits 35mm Eye Springs
TDUB-017	1	U-Bolt Kit		
TDUB-018	1	U-Bolt Kit		
TDGP-346	1	Greasable pins		Suits 25mm Eye Springs
TDGS-343	1	Greasable Shackles		Suits 25mm Eye Springs
TDGP-351	1	Greasable pins		Suits 35mm Eye Springs
TDGS-348	1	Greasable Shackles		Suits 35mm Eye Springs

REPLACEMENT BUSHINGS

QUANTITY PER SHOCK				
404702	2	Suits Front Top & bottom Eye		Eying Bushing
404702	2	Suits Rear Top & bottom Eye		Eying Bushing

Fitting sheet (located page 208) must be completed when suspension fitted. Failure to comply may affect warranty.

**KIT PRICING REFERENCE
COMPONENTS AS PER IMAGE**
please order using part numbers

TOYOTA
LANDCRUISER
1/65-84
45, 47 SERIES

REAR SUSPENSION

PART NO.	QTY	DESCRIPTION	RRP inc GST	NOTES
SHOCK ABSORBERS				
FC41382	2	41mm Foam Cell Shocks		Suit OE Height
BM401382	2	40mm 9 Stage Adjustable Shock		
FC41388	2	41mm Foam Cell Shocks		Suit 50mm Lift
BM401388	2	40mm 9 Stage Adjustable		
LEAF SPRINGS - Check Eye Size Prior to Ordering				
BP-014 (45 SERIES)	2	50mm Lift Spring - 30mm Eying		0-300kg Load
BP-014H (45 SERIES)	2	50mm Lift Spring - 30mm Eying		CONSTANT 300Kg Load
BP-016 (47 SERIES)	2	50mm Lift Spring - 35mm Eying		0-300kg Load
BP-016H (47 SERIES)	2	50mm Lift Spring - 35mm Eying		CONSTANT 300Kg Load
COMPONENTS				
TDUK-017	1	Urethane Shackle Bushing Kit		Suits 30mm Eye Springs
TDUK-012	1	Urethane Shackle Bushing Kit		Suits 35mm Eye Springs
TDUB-017	2	U-Bolt Kit		
TDGP-347	1	Greasable pins		Suits 30mm Eye Springs
TDGS-344/5	1	Greasable Shackles		Suits 30mm Eye Springs
TDGP-351	1	Greasable pins		Suits 35mm Eye Springs
TDGS-349/5	1	Greasable Shackles		Suits 35mm Eye Springs

COMPLETE KIT PRICE REFERENCE

SHOCK CHOICE	SPRING CHOICE	RRP inc GST	CONTENTS
41mm Foam Cell	BP-013 + BP-014 BP-013H+BP-014H BP-015+BP016 BP-015H+BP-016H		
40mm 9 Stage Adjustable	BP-013 + BP-014 BP-013H+BP-014H BP-015+BP016 BP-015H+BP-016H		
<p>Includes</p> <p>4 x Leaf Springs 4 x Shocks 2 x Urethane Kits 4 x U-Bolt Kits</p>			
Please Check Eye Size Prior to Ordering No Exchange for Special Order Parts			

All prices exclude freight. Include only permanent accessories & weights when selecting springs. Towing weight is not included

TOYOTA

LANDCRUISER

11/80-90
60, 61, 62 SERIES



FRONT SUSPENSION

ESTIMATED LIFT: 50mm

PART NO.	QTY	DESCRIPTION	RRP inc GST	NOTES
SHOCK ABSORBERS				
FC41113	2	41mm Foam Cell Shocks		Suit OE Height
BM401113	2	40mm 9 Stage Adjustable Shock		
FC41163	2	41mm Foam Cell Shocks		Suit 50mm Lift
BM401163	2	40mm 9 Stage Adjustable		
LEAF SPRINGS				
T43L	2	50mm Lift Spring		Petrol/Diesel/Bar
T43H	2	50mm Lift Spring		Petrol/Diesel/Bar/Winch
T53	2	50mm Lift Spring <i>(T/Diesel ONLY)</i>		Factory T.Diesel/Bar
T53H	2	50mm Lift Spring <i>(T/Diesel ONLY)</i>		Factory T.Diesel/Bar/Winch
STEERING STABILIZERS				
EXT5001	1	H/Duty Replacement Damper		Suits Power Steering
SS5001-P/S	1	Return to Centre Damper		
SV5001	1	9 Stage Adjustable Dampers		
COMPONENTS				
TDUK-012	1	Urethane Shackle Bushing Kit		
TDUB-019	2	U-Bolt Kit		
TDGP-351	1	Greasable pins		
TDGS-348	1	Greasable Shackles		
TAK-005	1	Offset King Pin		0.5 Degree
TAK-075	1	Offset King Pin		0.75 Degree
TAK-001	1	Offset King Pin		1.0 Degree

FRONT END KIT PRICE REFERENCE

SHOCK CHOICE	SPRING CHOICE	RRP inc GST	CONTENTS
41mm Foam Cell	T43L		
	T43H		
	T53		
	T53H		
40mm 9 Stage Adjustable	T43L		
	T43H		
	T53		
	T53H		
<p align="center">Includes</p> <p align="center">2 x Leaf Springs 2 x Shocks 2 x U-Bolt Kits 1 x Urethane Kit</p>			

Fitting sheet (located page 208) must be completed when suspension fitted. Failure to comply may affect warranty.

**KIT PRICING REFERENCE
COMPONENTS AS PER IMAGE**
please order using part numbers

TOYOTA
LANDCRUISER
11/80-90
60, 61, 62 SERIES

REAR SUSPENSION

PART NO.	QTY	DESCRIPTION	RRP inc GST	NOTES
SHOCK ABSORBERS				
FC41366	2	41mm Foam Cell Shocks		Suit OE Height
BM401366	2	40mm 9 Stage Adjustable Shock		11/80-10/85 Models ONLY
FC41382	2	41mm Foam Cell Shocks		Suit 50mm Lift 11/80-10/85 Models ONLY
BM401382	2	40mm 9 Stage Adjustable		
FC41350	2	41mm Foam Cell Shocks		Suits Up to 50mm 10/85-91 Models ONLY
BM401350	2	40mm 9 Stage Adjustable		
LEAF SPRINGS				
T44L	2	0-300Kg Load		50mm Lift Spring
T44H	2	CONSTANT 300Kg Load		50mm Lift Spring
T44HM	2	CONSTANT 500Kg Load		50mm Lift Spring
COMPONENTS				
TDUK-012	1	Urethane Shackle Bushing Kit		
TDUB-017	2	U-Bolt Kit		
TDGP-351	1	Greasable pins		
TDGS-357	1	Greasable Shackles		

REPLACEMENT BUSHINGS

QUANTITY PER SHOCK				
TW959	2	Suits Top Front Pin		Pin Style Bushing
ADJ00191	1	Suits Bottom Front Eying		Eying Bushing
404702	2	Suits Top & Bottom Rear Eying		Eying Bushing (#1382)
ADJ00191	2	Suits Top & Bottom Rear Eying		Eying Bushing (#1350)

REAR KIT PRICE REFERENCE

SHOCK CHOICE	SPRING CHOICE	RRP inc GST	CONTENTS
41mm Foam Cell	T44L 0-300Kg T44H 300Kg + T44HM 500Kg +		
40mm 9 Stage Adjustable	T44L 0-300Kg T44H 300Kg + T44HM 500Kg +		
Includes 2 x Leaf Springs 2 x Shocks 1 x Urethane Kits 2 x U-Bolt Kits			

All prices exclude freight. Include only permanent accessories & weights when selecting springs. Towing weight is not included

TOYOTA

LANDCRUISER

11/84-91
70 SERIES BUNDERA



FRONT SUSPENSION

ESTIMATED LIFT: 40mm

PART NO.	QTY	DESCRIPTION	RRP inc GST	NOTES
SHOCK ABSORBERS				
FC41005	2	41mm Foam Cell Shocks		OE Height
FC41007	2	41mm Foam Cell Shocks		40mm Lift
COIL SPRINGS				
TDC941L	2	40mm Lift Spring		Suit Petrol/Diesel/Bar
STEERING DAMPERS				
EXT5001	1	H/D Replacement Damper		
SS5001-P/S	1	Return to Centre Damper		
SV5001	1	9 Stage Adjustable Damper		
COMPONENTS				
TDUK-042	1	Radius Rod to Diff		2 Kits Required
TDUK-041	1	Radius Rod to Chassis		1 Kit Required

REAR SUSPENSION

SHOCK ABSORBERS				
FC43005	1	41mm Foam Cell Shocks		OE Height - D/S
FC41107	1	41mm Foam Cell Shocks		OE Height - P/S
FC41350	1	41mm Foam Cell Shocks		40mm Lift - D/S
FC41108	1	41mm Foam Cell Shocks		40mm Lift - P/S
COIL SPRINGS				
TDC942L	2	0-300Kg Load		40mm Lift Spring
COMPONENTS				
TDUK-042	1	Radius Rod to Diff		2 Kits Required
TDUK-041	1	Radius Rod to Chassis		1 Kit Required

REPLACEMENT BUSHINGS

QUANTITY PER SHOCK (check shock fittings prior to ordering)				
TW959	4	Suits Top & Bottom Front Pin		Pin Style Bushing
TW959	2	Suits Top Rear Pin		Eyering Bushing #1108 & #1107
ADJ00191	2	Suits Top & Bottom Rear Eyering		Eyering Bushing #1350 & #3005
ADJ00191	2	Suits Top & Bottom Eye		Eyering Bushing #1108 & #1107

COMPLETE KIT PRICE REFERENCE

SHOCK CHOICE	SPRING CHOICE	RRP inc GST	CONTENTS
41mm Foam Cell	40mm LIFT		
Includes 4 x Coil Springs 4 x Shocks			

Fitting sheet (located page 208) must be completed when suspension fitted. Failure to comply may affect warranty.



TOYOTA

LANDCRUISER

HZJ71 & HZJ74

71, 74 SERIES SWB & LWB

FRONT SUSPENSION

ESTIMATED LIFT: 50mm

PART NO.	QTY	DESCRIPTION	RRP inc GST	NOTES
SHOCK ABSORBERS				
FC41050	2	41mm Foam Cell Shocks		Up to 50mm Lift
BM401050	2	40mm 9 Stage Adjustable		Up to 50mm Lift
BMX1050/2	2	45mm 9 Stage Adjustable		50mm Lift
TDR1050B	2	53mm 'Ralph' Big Bore		Up to 50mm Lift
COIL SPRINGS				
TDC950SL	2	50mm Lift Spring		Suit Petrol/Diesel/Bar
TDC950L	2	50mm Lift Spring		Suit Petrol/Diesel/Bar/Winch
STEERING DAMPERS				
EXT5001	1	H/D Replacement Damper		
SS5001-P/S	1	Return to Centre Damper		
SV5001	1	9 Stage Adjustable Damper		

REAR SUSPENSION

SHOCK ABSORBERS				
FC41377	2	41mm Foam Cell Shocks		50mm Lift
BM401377	2	40mm 9 Stage Adjustable		50mm Lift
BMX1377/2	2	45mm 9 Stage Adjustable		50mm Lift
TDR1377	2	53mm 'Ralph' Big Bore		50mm Lift
LEAF SPRINGS				
T44L	2	0-300Kg Load		50mm Lift Spring
T44H	2	CONSTANT 300Kg Load		50mm Lift Spring
COMPONENTS				
TDUK-012	1	Urethane Bushing kit		1 Kits Required
TDUB-017	2	U-Bolt Kits		2 Kit Required

FRONT END KIT PRICE REFERENCE

SHOCK CHOICE	SPRING CHOICE	RRP inc GST	CONTENTS
41mm Foam Cell	0-300KG		
	300KG +		
40mm 9 Stage Adjustable	0-300KG		
	300KG +		
45mm Adjustable or 53mm Ralph	0-300KG		
	300KG +		
<p align="center">Includes</p> <p align="center">2 X Coil Springs 2 x Leaf Springs 4 x Shocks</p> <p align="center">2 x U-Bolt Kits 1 x Urethane Kit</p>			

All prices exclude freight. Include only permanent accessories & weights when selecting springs. Towing weight is not included

P: (02) 9672 8899 | F: (02) 9672 8099



TOYOTA

LANDCRUISER

11/84-92
70, 73, 74 SERIES



FRONT SUSPENSION

ESTIMATED LIFT: 50mm

PART NO.	QTY	DESCRIPTION	RRP inc GST	NOTES
SHOCK ABSORBERS				
FC41113	2	41mm Foam Cell Shocks		OE Height
BM401113	2	40mm 9 Stage Adjustable		OE Height
FC41163	2	41mm Foam Cell Shocks		50mm Lift
BM401163	2	40mm 9 Stage Adjustable		50mm Lift
BMX1163/2	2	45mm 9 Stage Adjustable		50mm Lift
TDR1163B	2	53mm 'Ralph' Big Bore		50mm Lift
LEAF SPRINGS				
T52	2	50mm Lift Spring		Suit Petrol/Diesel/Bar
STEERING DAMPERS				
EXT5001	1	H/D Replacement Damper		
SS5001-P/S	1	Return to Centre Damper		
SV5001	1	9 Stage Adjustable Damper		
COMPONENTS				
TDUK-012	1	Urethane Bushing kit		1 Kits Required
TDUB-019	2	U-Bolt Kits		2 Kit Required
TDGP-351	1	Greasable Pins		
TDGS-357	1	Greasable Shackles		
TAK-005	1	Offset King Pin		Fits to Top of Knuckle
TAK-075	1	Offset King Pin		Fits to Top of Knuckle
TAK-001	1	Offset King Pin		Fits to Top of Knuckle

REPLACEMENT BUSHINGS

QUANTITY PER SHOCK (check shock fittings prior to ordering)				
TW959	2	Suits Top front Pin		Pin Style Bushing
ADJ00191	1	Suits Bottom Front Eye		Eyering Bushing
ADJ00191	2	Suits Top & Bottom Rear Eyering		Eyering Bushing

Fitting sheet (located page 208) must be completed when suspension fitted. Failure to comply may affect warranty.

TOYOTA

LANDCRUISER

11/84-92
70, 73, 74 SERIES

REAR SUSPENSION

PART NO.	QTY	DESCRIPTION	RRP inc GST	NOTES
SHOCK ABSORBERS				
FC41350	2	41mm Foam Cell Shocks		OE Height
BM401350	2	40mm 9 Stage Adjustable		OE Height
FC41377	2	41mm Foam Cell Shocks		50mm Lift
BM401377	2	40mm 9 Stage Adjustable		50mm Lift
BMX1377/2	2	45mm 9 Stage Adjustable		50mm Lift
TDR1377	2	53mm 'Ralph' Big Bore		50mm Lift
LEAF SPRINGS				
T44L	2	0-300Kg Load		50mm Lift Spring
T44H	2	CONSTANT 300Kg Load		50mm Lift Spring
COMPONENTS				
TDUK-012	1	Urethane Bushing kit		1 Kits Required
TDUB-017	2	U-Bolt Kits		2 Kit Required
TDGP-351	1	Greasable Pins		
TDGS-357	1	Greasable Shackles		

COMPLETE KIT PRICE REFERENCE

SHOCK CHOICE	SPRING CHOICE	RRP inc GST	CONTENTS
41mm Foam Cell	T44L 0-300Kg		
	T44H 300Kg +		
40mm 9 Stage Adjustable	T44L 0-300Kg		
	T44H 300Kg +		
45mm 9 Stage Adjustable or 53mm Ralph	T44L 0-300Kg		
	T44H 300Kg +		
<p align="center">Includes</p> <p>4 x Leaf Springs 4 x Shocks 2 x Urethane Kits 4 x U-Bolt Kits</p>			

All prices exclude freight. Include only permanent accessories & weights when selecting springs. Towing weight is not included

TOYOTA

LANDCRUISER

11/84-99
75 SERIES



FRONT SUSPENSION

ESTIMATED LIFT: 50mm

PART NO.	QTY	DESCRIPTION	RRP inc GST	NOTES
SHOCK ABSORBERS				
FC41113B	2	41mm Foam Cell Shocks		Suit OE Height
FC41163B	2	41mm Foam Cell Shocks		Suit 50mm Lift (HZJ75 3/90-99)
FC41163	2	41mm Foam Cell Shocks		Suit 50mm Lift All except HZJ75
BM401163	2	40mm 9 Stage Adjustable Shock		Suits All Models
BMX1163/2	2	45mm 9 Stage Adjustable		
TDR1163B	2	53mm 'Ralph' Big Bore		
LEAF SPRINGS				
T52	2	50mm Lift Spring		Petrol/Diesel/Bar
T52H	2	50mm Lift Spring		Petrol/Diesel/Bar/Winch
STEERING STABILIZERS				
EXT5001	1	H/Duty Replacement Damper		Suits Power Steering
SS5001-P/S	1	Return to Centre Damper		
SV5001	1	9 Stage Adjustable Dampers		
COMPONENTS				
TDUK-012	1	Urethane Shackle Bushing Kit		0.5 Degree 0.75 Degree 1.0 Degree
TDUB-019	2	U-Bolt Kit		
TDGP-351	1	Greasable pins		
TDGS-357	1	Greasable Shackles		
TAK-005	1	Offset King Pin		
TAK-075	1	Offset King Pin		
TAK-001	1	Offset King Pin		

FRONT END KIT PRICE REFERENCE

SHOCK CHOICE	SPRING CHOICE	RRP inc GST	CONTENTS
41mm Foam Cell	T52 T52H		
40mm 9 Stage Adjustable	T52 T52H		
45mm Adjustable or 53mm Ralph	T52 T52H		
Includes 2 x Leaf Springs 2 x Shocks 2 x U-Bolt Kits 1 x Urethane Kit			

Fitting sheet (located page 208) must be completed when suspension fitted. Failure to comply may affect warranty.

**KIT PRICING REFERENCE
COMPONENTS AS PER IMAGE**
please order using part numbers

TOYOTA
LANDCRUISER
11/84-99
75 SERIES

REAR SUSPENSION

PART NO.	QTY	DESCRIPTION	RRP inc GST	NOTES
SHOCK ABSORBERS				
FC41350	2	41mm Foam Cell Shocks		Suit OE Height
FC41377	2	41mm Foam Cell Shocks		
BM401377	2	40mm 9 Stage Adjustable Shock		Suit 50mm Lift
BMX1377/2	2	45mm 9 Stage Adjustable		
TDR1377	2	53mm 'Ralph' Big Bore		
LEAF SPRINGS				
T51	2	0-300Kg Load		50mm Lift Spring
FS751M	2	CONSTANT 300Kg Load		50mm Lift Spring
FS751HM	2	CONSTANT 500Kg Load		50mm Lift Spring
COMPONENTS				
TDUK-018	1	Urethane Shackle Bushing Kit		
TDUB-017	2	U-Bolt Kit		
TDSP-014	1	Brake Bias Bracket		
TDGP-354	1	Greasable pins		
TDGS-357	1	Greasable Shackles		
AIR ASSIST BAGS				
TDAA-115	1	Bellows bag kit		Suits 30mm to 75mm Lift
TDAA-121	1	Bellows bag kit		Suits standard height ONLY

REPLACEMENT BUSHINGS

QUANTITY PER SHOCK				
TW959	2	Suits Top Front Pin		Pin Style Bushing
ADJ00191	1	Suits Bottom Front Eying		Eying Bushing
ADJ00191	2	Suits Top & Bottom Rear Eye		Eying Bushing

REAR KIT PRICE REFERENCE

SHOCK CHOICE	SPRING CHOICE	RRP inc GST	CONTENTS
41mm Foam Cell	T51 0-300Kg FS751M 300Kg + FS751HM 500Kg +		
40mm 9 Stage Adjustable	T51 0-300Kg FS751M 300Kg + FS751HM 500Kg +		
45mm Adjustable or 53mm Ralph	T51 0-300Kg FS751M 300Kg + FS751HM 500Kg +		
Includes 2 x Leaf Springs 2 x Shocks 1 x Urethane Kits 2 x U-Bolt Kits			

All prices exclude freight. Include only permanent accessories & weights when selecting springs. Towing weight is not included

TOYOTA

LANDCRUISER

07 on
76 SERIES WAGON



FRONT SUSPENSION

ESTIMATED LIFT: 50mm

PART NO.	QTY	DESCRIPTION	RRP inc GST	NOTES
SHOCK ABSORBERS				
FC41050	2	41mm Foam Cell Shocks		Up to 50mm Lift
BM401050	2	40mm 9 Stage Adjustable Shock		Up to 50mm Lift
BMX1050/2	2	45mm 9 Stage Adjustable		50mm Lift
TDR1050B	2	53mm 'Ralph' Big Bore		Up to 50mm Lift
COIL SPRINGS				
TDC950SL	2	OE Height Spring		Suits OE Height Petrol/Diesel/Bar
TDC950L	2	50mm Lift Spring		Petrol/Diesel/Bar
TDC950HL	2	50mm Lift Spring		Petrol/Diesel/Bar/Winch
STEERING STABILIZERS				
EXT5004	1	H/Duty Replacement Damper		Suits Power Steering
SS5004-P/S	1	Return to Centre Damper		
SV5004	1	9 Stage Adjustable Dampers		
CASTER CORRECTION				
TDUK-054/2	1	2 Degree Caster Correction		Optional Component
PANHARD RODS				
TDPR-015	1	Adjustable Panhard Rod		
COMPONENTS				
TDSP-013	1	Front Swaybar spacer kit		fit if tailshaft contacts swaybar 0.5 Degree 0.75 Degree 1.0 Degree
TAK-8005	1	Offset King Pin		
TAK-8075	1	Offset King Pin		
TAK-8001	1	Offset King Pin		
TDUK-1961/30	1	Urethane Spring Spacers 30mm		

COMPLETE KIT PRICE REFERENCE

SHOCK CHOICE	SPRING CHOICE	RRP inc GST	CONTENTS
41mm Foam Cell Includes 2 x Coil Springs 4 x Shocks 2 x Leaf Springs 2 x U-Bolt Kits 1 x Urethane Kit (TDUK-048)	FS761 0-300KG		
	FS761M CONSTANT 300KG		
	FS761HM CONSTANT 500KG		



**KIT PRICING REFERENCE
COMPONENTS AS PER IMAGE**
please order using part numbers

TOYOTA
LANDCRUISER
07 On
76 SERIES WAGON

REAR SUSPENSION

PART NO.	QTY	DESCRIPTION	RRP inc GST	NOTES
SHOCK ABSORBERS				
FC41377	2	41mm Foam Cell Shocks		Up to 50mm Lift
BM401377	2	40mm 9 Stage Adjustable Shock		Up to 50mm Lift
BMX1377/2	2	45mm 9 Stage Adjustable		50mm Lift
TDR1377	2	53mm 'Ralph' Big Bore		Up to 50mm Lift
LEAF SPRINGS				
FS761	2	0-300Kg Load		50mm Lift Spring
FS761M	2	CONSTANT 300Kg Load		50mm Lift Spring
FS761HM	2	CONSTANT 500Kg Load		50mm Lift Spring
COMPONENTS				
TDUK-048	1	Urethane Bushing Kit pre 01/17		Use w Greasable pins & shackles (all years)
TDUK-048/14	1	Urethane Bushing Kit post 01/17		
TDUB-024	2	U-Bolt Kit		Suits up to build date 01/2017 Fit with BMX or TDR shocks
TDSP-014	1	Brake Bias Bracket		
TDSP-015	1	Handbrake relocation bracket		
TDGP-388	1	Greasable pins		
TDGS-387/18	1	Greasable Shackles		
AIR ASSIST BAGS				
TDAA-115	1	Bellows bag kit		Suits 30mm to 75mm Lift
TDAA-121	1	Bellows bag kit		Suits standard height ONLY

COMPLETE KIT PRICE REFERENCE *Final Kit price varies by TDUK. Price shown incl. TDUK-048*

SHOCK CHOICE	SPRING CHOICE	RRP inc GST	CONTENTS
40mm 9 Stage Adjustable <u>Includes</u> 2 x Coil Springs 4 x Shocks 2 x Leaf Springs 2 x U-Bolt Kits 1 x Urethane Kit (TDUK-048)	FS761 0-300KG		
	FS761M CONSTANT 300KG		
	FS761HM CONSTANT 500KG		
45mm Adjustable or 53mm 'Ralph' Big Bore <u>Includes</u> 2 x Coil Springs 4 x Shocks 2 x Leaf Springs 2 x U-Bolt Kits 1 x Urethane Kit 1 x H'brake bkt Kit	FS761 0-300KG		
	FS761M CONSTANT 300KG		
	FS761HM CONSTANT 500KG		

All prices exclude freight. Include only permanent accessories & weights when selecting springs. Towing weight is not included

TOYOTA

LANDCRUISER

93-99

77 SERIES FZJ77, HZJ77, PZJ77



FRONT SUSPENSION

ESTIMATED LIFT: 50mm

PART NO.	QTY	DESCRIPTION	RRP inc GST	NOTES
SHOCK ABSORBERS				
FC41113B	2	41mm Foam Cell Shocks		Suit OE Height
FC41163B	2	41mm Foam Cell Shocks		
BM401163	2	40mm 9 Stage Adjustable Shock		Suit 50mm Lift
BMX1163/2	2	45mm 9 Stage Adjustable		
TDR1163B	2	53mm 'Ralph' Big Bore		
LEAF SPRINGS				
T52	2	50mm Lift Spring		Petrol/Diesel/Bar
T52H	2	50mm Lift Spring		Petrol/Diesel/Bar/Winch
STEERING STABILIZERS				
EXT5001	1	H/Duty Replacement Damper		
SS5001-P/S	1	Return to Centre Damper		Suits Power Steering
SV5001	1	9 Stage Adjustable Dampers		
COMPONENTS				
TDUK-012	1	Urethane Shackle Bushing Kit		
TDUB-019	1	U-Bolt Kit		
TDGP-351	1	Greasable pins		
TDGS-348	1	Greasable Shackles		

REAR SUSPENSION

SHOCK ABSORBERS				
FC41377	2	41mm Foam Cell Shocks		Up to 50mm Lift
BM401377	2	40mm 9 Stage Adjustable Shock		Up to 50mm Lift
BMX1377/2	2	45mm 9 Stage Adjustable		50mm Lift
TDR1377B	2	53mm 'Ralph' Big Bore		Up to 50mm Lift
LEAF SPRINGS - Check Eye Size Prior to Ordering				
FS761	2	0-300Kg Load		50mm Lift Spring
FS761M	2	CONSTANT 300Kg Load		50mm Lift Spring
COMPONENTS				
TDUK-018	1	Urethane Shackle Bushing Kit		
TDUB-017	2	U-Bolt Kit		
TDGP-354	1	Greasable pins		
TDGS-357	1	Greasable Shackles		

REPLACEMENT BUSHINGS

QUANTITY PER SHOCK (check shock fittings prior to ordering)				
PART NO.	QTY	DESCRIPTION	RRP inc GST	NOTES
TW959	2	Suits Top Front Pin		Pin Style Bushing
ADJ00191	1	Suits Front Bottom Eye		Eyering Bushing
ADJ00191	2	Suits Top & Bottom Rear Eyering		Eyering Bushing

Fitting sheet (located page 208) must be completed when suspension fitted. Failure to comply may affect warranty.



TOYOTA LANDCRUISER KZJ78 (INTERNATIONAL 78 SERIES WITH COIL SPRINGS

FRONT SUSPENSION

ESTIMATED LIFT: 50mm

PART NO.	QTY	DESCRIPTION	RRP inc GST	NOTES
SHOCK ABSORBERS				
FC41254	2	41mm Foam Cell Shocks		Up to 50mm Lift
BM401254	2	40mm 9 Stage Adjustable		Up to 50mm Lift
COIL SPRINGS				
TDC960L	2	50mm Lift Spring		Suit Petrol/Diesel/Bar
TDC960HL	2	50mm Lift Spring		Suit Petrol/Diesel/Bar/Winch
STEERING DAMPERS				
EXT5001	1	H/D Replacement Damper		
SS5001-P/S	1	Return to Centre Damper		
SV5001	1	9 Stage Adjustable Damper		

REAR SUSPENSION

SHOCK ABSORBERS				
FC41255	2	41mm Foam Cell Shocks		50mm Lift
BM401255	2	40mm 9 Stage Adjustable		50mm Lift
COIL SPRINGS				
TDC961L	2	0-300Kg Load		50mm Lift Spring
TDC961HL	2	CONSTANT 300Kg Load		50mm Lift Spring

FRONT END KIT PRICE REFERENCE

SHOCK CHOICE	SPRING CHOICE	RRP inc GST	CONTENTS
41mm Foam Cell	ANY COIL		
40mm 9 Stage Adjustable	ANY COIL		
Includes 4 x Coil Springs 4 x Shocks			

All prices exclude freight. Include only permanent accessories & weights when selecting springs. Towing weight is not included

P: (02) 9672 8899 | F: (02) 9672 8099



TOYOTA

LANDCRUISER

10/99 On

78, 79 SERIES INC V8 (EXCEPT DUAL CAB)



FRONT SUSPENSION

ESTIMATED LIFT: 50mm

PART NO.	QTY	DESCRIPTION	RRP inc GST	NOTES
SHOCK ABSORBERS				
FC41050	2	41mm Foam Cell Shocks		Up to 50mm Lift
BM401050	2	40mm 9 Stage Adjustable Shock		Up to 50mm Lift
BMX1050/2	2	45mm 9 Stage Adjustable		50mm Lift
TDR1050B	2	53mm 'Ralph' Big Bore		Up to 50mm Lift
COIL SPRINGS				
TDC950SL	2	OE Height Spring		Suits OE Height Petrol/Diesel/Bar
TDC950L	2	50mm Lift Spring		Petrol/Diesel/Bar
TDC950HL	2	50mm Lift Spring		Petrol/Diesel/Bar/Winch
STEERING STABILIZERS				
EXT5001	1	H/Duty Replacement Damper		Suits 6 Cylinder Models
SS5001-P/S	1	Return to Centre Damper		
SV5001	1	9 Stage Adjustable Dampers		
EXT5004	1	H/Duty Replacement Damper		Suits V8 Models
SS5004-P/S	1	Return to Centre Damper		
SV5004	1	9 Stage Adjustable Dampers		
CASTER CORRECTION				
TDUK-054/2	1	2 Degree Caster Correction		instructions at toughdog.com.au
PANHARD RODS				
TDPR-079	1	Adjustable Panhard Rod		Suits 6 Cylinder Engine
TDPR-015	1	Adjustable Panhard Rod		Suit V8 only up to '08/16
TDPR-006	1	Adjustable Panhard Rod		Suit V8 from '09/16 (5 star ANCAP)
TDPR-019	1	Adjustable Panhard Rod		LHD Vehicles (6 Cylinder)
TDPR-025	1	Adjustable Panhard Rod		LHD Vehicles (8 Cylinder)
COMPONENTS				
TDSP-013	1	Front Swaybar spacer kit		fit if tailshaft contacts swaybar
TDUK-1961/30	1	30mm Urethane Spring Spacer		
TDUK-043	1	Panhard Rod Bushings		Suits all Panhard Rods above
TAK-8005	1	Offset King Pin		0.5 Degree
TAK-8075	1	Offset King Pin		0.75 Degree
TAK-8001	1	Offset King Pin		1.0 Degree

COMPLETE KIT PRICE REFERENCE

Note: FS781XHD kit price includes rear sway bar

SHOCK CHOICE	SPRING CHOICE	RRP inc GST	CONTENTS
41mm Foam Cell Includes 2 x Coil Springs 4 x Shocks 2 x Leaf Springs 2 x U-Bolt Kits 1 x Urethane Kit (TDUK-048)	BP-019 0-200KG		
	FS781 CONSTANT 400KG		
	FS781HM CONSTANT 600KG		
	FS781XHD CONSTANT 900KG		

Fitting sheet (located page 208) must be completed when suspension fitted. Failure to comply may affect warranty.



Note: Urethane Bushing kit fitting instructions available at toughdog.com.au

TOYOTA LANDCRUISER 10/99 On 78, 79 SERIES INC V8 (EXCEPT DUAL CAB)

REAR SUSPENSION

PART NO.	QTY	DESCRIPTION	RRP inc GST	NOTES
SHOCK ABSORBERS				
FC41377	2	41mm Foam Cell Shocks		Up to 50mm Lift
BM401377	2	40mm 9 Stage Adjustable Shock		Up to 50mm Lift
BMX1377/2	2	45mm 9 Stage Adjustable		50mm Lift
TDR1377	2	53mm 'Ralph' Big Bore		Up to 50mm Lift
LEAF SPRINGS - **NOTE: Include weight of tray when calculating CONSTANT LOAD**				
BP-019	2	0-200Kg Load		50mm Lift Spring
FS781	2	CONSTANT 400Kg Load		50mm Lift Spring
FS781HM	2	CONSTANT 600Kg Load		50mm Lift Spring
FS781XHD	2	CONSTANT 900Kg Load		50mm Lift - Fit TDSB-008 also
COMPONENTS				
TDSB-008	1	Heavy Duty Sway Bar		Fit with Constant 900kg springs
TDSB-012	1	Heavy Duty Sway Bar		Fit with Constant 900kg suits 5 Star ANCAP vehicles only
TDUK-048	1	Urethane Shackle Bushing Kit		Suits V8 & w G' Pins & Shackles
TDUK-048/14	1	Urethane Shackle Bushing Kit		For Utes built before 06/2009
TDUK-048/18	1	Urethane Shackle Bushing Kit		For T'carrier built before 06/2009
TDUB-024	2	U-Bolt Kit (230mm long)		
TDUB-038	2	U-Bolt Kit (290mm long)		For use with FS781XHD
TDSP-014	1	Brake Bias Bracket		Not req'd when built after 01/17
TDSP-015	1	Handbrake relocation bracket		Fit with BMX or TDR shocks
TDGP-388	1	Greasable pins		
TDGS-387/18	1	Greasable Shackles		
AIR ASSIST BAGS				
TDAA-115	1	Bellows bag kit		Suits 30mm to 75mm Lift
TDAA-121	1	Bellows bag kit		Suits standard height ONLY

COMPLETE KIT PRICE REFERENCE Final Kit price varies by TDUK. Price shown incl. TDUK-048

SHOCK CHOICE	SPRING CHOICE	RRP inc GST	CONTENTS
40mm 9 Stage Adjustable Includes 2 x Springs 4 x Shocks 2 x Leaf Springs 2 x U-Bolt Kits 1 x Urethane	BP-019 0-200KG		 Note: FS781XHD kit price includes rear sway bar
	FS781 400KG+		
	FS781HM 600KG+		
	FS781XHD 900KG		
45mm Adj or 53mm Big Bore Includes 2 x Springs 4 x Shocks 2 x Leaf Springs 2 x U-Bolt Kits 1 x Urethane Kit 1 x H'brake bkt Kit	BP-019 0-200KG		
	FS781 400KG+		
	FS781HM 600KG+		
	FS781XHD 900KG		

All prices exclude freight. Include only permanent accessories & weights when selecting springs. Towing weight is not included

P: (02) 9672 8899 | F: (02) 9672 8099



TOYOTA

LANDCRUISER

12 On

79 SERIES DUAL CAB



FRONT SUSPENSION

ESTIMATED LIFT: 50mm

PART NO.	QTY	DESCRIPTION	RRP inc GST	NOTES
SHOCK ABSORBERS				
FC41050	2	41mm Foam Cell Shocks		Up to 50mm Lift
BM401050	2	40mm 9 Stage Adjustable Shock		Up to 50mm Lift
BMX1050/2	2	45mm 9 Stage Adjustable		50mm Lift
TDR1050B	2	53mm 'Ralph' Big Bore		Up to 50mm Lift
COIL SPRINGS				
TDC950SL	2	OE Height Spring		Suits OE Height Petrol/Diesel/Bar
TDC950L	2	50mm Lift Spring		Petrol/Diesel/Bar
TDC950HL	2	50mm Lift Spring		Petrol/Diesel/Bar/Winch
STEERING STABILIZERS				
EXT5004	1	H/Duty Replacement Damper		
SS5004-P/S	1	Return to Centre Damper		Suits V8 Models
SV5004	1	9 Stage Adjustable Dampers		
CASTER CORRECTION				
TDUK-054/2	1	2 Degree Caster Correction		instructions at toughdog.com.au
PANHARD RODS				
TDPR-015	1	Adjustable Panhard Rod		
TDPR-006	1	Adjustable Panhard Rod		Suit V8 from '09/16 (5 star ANCAP)
TDPR-025	1	Adjustable Panhard Rod		LHD Vehicles (8 Cylinder)
COMPONENTS				
TDSP-013	1	Front Swaybar spacer kit		fit if tailshaft contacts swaybar
TDUK-1961/30	1	30mm Urethane Spring Spacer		
TAK-8005	1	Offset King Pin		0.5 Degree
TAK-8075	1	Offset King Pin		0.75 Degree
TAK-8001	1	Offset King Pin		1.0 Degree

REPLACEMENT BUSHINGS

QUANTITY PER SHOCK				
TW957	4	Suits Top & Bottom Front Pin		Pin Style Bushing
ADJ00191	2	Suits Top & Bottom Rear Eye		Eyering Bushing

COMPLETE KIT PRICE REFERENCE

SHOCK CHOICE	SPRING CHOICE	RRP inc GST	CONTENTS
41mm Foam Cell Includes 2 x Coil Springs 4 x Shocks 2 x Leaf Springs 2 x U-Bolt Kits 1 x Urethane Kit (TDUK-048)	FS781 CONSTANT 300KG		
	FS781HM CONSTANT 500KG		
	FS781XHD CONSTANT 800KG		

Fitting sheet (located page 208) must be completed when suspension fitted. Failure to comply may affect warranty.



Note: Urethane Bushing kit fitting instructions available at toughdog.com.au

TOYOTA LANDCRUISER 12 On 79 SERIES DUAL CAB

REAR SUSPENSION

PART NO.	QTY	DESCRIPTION	RRP inc GST	NOTES
SHOCK ABSORBERS				
FC41377	2	41mm Foam Cell Shocks		Up to 50mm Lift
BM401377	2	40mm 9 Stage Adjustable Shock		Up to 50mm Lift
BMX1377/2	2	45mm 9 Stage Adjustable		50mm Lift
TDR1377	2	53mm 'Ralph' Big Bore		Up to 50mm Lift
LEAF SPRINGS - OE vehicle weight based on cab chassis (excludes tub/tray)				
FS781	2	CONSTANT 300Kg Load		50mm Lift Spring
FS781HM	2	CONSTANT 500Kg Load		50mm Lift Spring
FS781XHD	2	CONSTANT 800Kg Load		50mm Lift - Fit TDSB-008 also
COMPONENTS				
TDSB-008	1	Heavy Duty Sway Bar		Fit with Constant 800kg springs
TDUK-048	1	Urethane Shackle Bushing Kit		
TDUB-024	2	U-Bolt Kit (230mm long)		
TDUB-038	2	U-Bolt Kit (290mm long)		For use with FS781XHD
TDSP-014	1	Brake Bias Bracket		Not req'd when built after 01/17
TDSP-015	1	Handbrake relocation bracket		Fit with BMX or TDR shocks
TDGP-388	1	Greasable pins		
TDGS-387/18	1	Greasable Shackles		
AIR ASSIST BAGS				
TDAA-115	1	Bellows bag kit		Suits up to 75mm Lift
TDAA-121	1	Bellows bag kit		Suits standard height ONLY

COMPLETE KIT PRICE REFERENCE

SHOCK CHOICE	SPRING CHOICE	RRP inc GST	CONTENTS
40mm 9 Stage Adjustable Includes 2 x Springs 4 x Shocks 2 x Leaf Springs 2 x U-Bolt Kits 1 x Urethane Kit	FS781 CONSTANT 300KG		
	FS781HM CONSTANT 500KG		
	FS781XHD CONSTANT 800KG		
45mm Adjustable or 53mm 'Ralph' Big Bore Includes 2 x Springs 4 x Shocks 2 x Leaf Springs 2 x U-Bolt Kits 1 x Urethane Kit 1 x H'brake bkt Kit	FS781 CONSTANT 300KG		
	FS781HM CONSTANT 500KG		
	FS781XHD CONSTANT 800KG		

Note: FS781XHD kit price includes rear sway bar

All prices exclude freight. Include only permanent accessories & weights when selecting springs. Towing weight is not included

P: (02) 9672 8899 | F: (02) 9672 8099



TOYOTA

LANDCRUISER

3/90-06
80 & 105 SERIES



FRONT SUSPENSION

ESTIMATED LIFT: 50mm

PART NO.	QTY	DESCRIPTION	RRP inc GST	NOTES
SHOCK ABSORBERS				
FC41002	2	41mm Foam Cell Shocks		Suits up to 50mm Lift
BM401002	2	40mm 9 Stage Adjustable Shock		Suits up to 50mm Lift
BMX1002/2	2	45mm 9 Stage Adjustable Shock		Suits 50mm Lift ONLY
TDR1002B	2	53mm 'Ralph' Big Bore Shock		Suits up to 50mm Lift
COIL SPRINGS				
TDC943S	2	Petrol/Alloy Bar		3/90-91 80 Series Application Suits 25mm Lift
TDC948L	2	Diesel/Bar		
TDC948HL	2	Petrol/Diesel Bar & Winch		
TDC943	2	Petrol/Diesel Bar		3/90-91 80 Series Application Suits 50mm Lift
TDC943H	2	Petrol/Diesel Bar & Winch		
TDC948SL	2	Petrol/Alloy Bar		9/91-98 80 Series & 3/98-07 100 Series Application Suits 25mm Lift
TDC948HSL	2	Petrol/Diesel Bar & Winch		
TDC948L	2	Petrol Deisel Bar, Winch & D/Batt		
TDC943S	2	80 Series ONLY No bar		9/91-98 80 Series & 3/98-07 100 Series Application Suits 50mm Lift
TDC948L	2	Petrol/Diesel/Bar		
TDC948HL	2	Petrol Diesel/Bar/Winch		
TDC943H	2	Petrol Diesel/Bar/Winch/D.Batt		
STEERING STABILIZERS				
EXT5001	1	H/Duty Replacement Damper		
SS5001-P/S	1	Return to Centre Damper		
SV5001	1	9 Stage Adjustable Damper		
CASTER CORRECTION				
TDUK-054/2	1	2 Degree Caster Correction Bush		instructions at toughdog.com.au
PANHARD ROD				
TDPR-006	1	Adjustable Panhard Rod		
TDPR-001	1	Adjustable Panhard Rod		LHD ONLY
COMPONENTS				
TDUK-044	1	Front Radius Rod to Chassis		1 Kit required per vehicle
TDUK-050	1	Front Radius Rod to Diff		1 Kit required per vehicle
TDUK-043	1	Panhard Rod Bush Kit		1 Kit required per panhard rod
TDUK-1725/20	1	Urethane Spring Spacer 20mm		1 required per coil as required
TDUK-1725/30	1	Urethane Spring Spacer 30mm		1 required per coil as required
TAK-8005	1	Offset Kingpin		0.5 Degree
TAK-8075	1	Offset Kingpin		0.75 Degree
TAK-8001	1	Offset Kingpin		1.0 Degree

REPLACEMENT BUSHINGS

QUANTITY PER SHOCK (check shock fittings prior to ordering)				
TW957	4	Suits Top & Bottom Front Pin		Pin Style Bushing
TW957	2	Suits Top Rear Pin		Pin Style Bushing
415024	1	Suits Bottom Rear Eying		Eying Bushing

Fitting sheet (located page 208) must be completed when suspension fitted. Failure to comply may affect warranty.

**KIT PRICING REFERENCE
COMPONENTS AS PER IMAGE**
please order using part numbers

TOYOTA
LANDCRUISER
3/90-06
80 & 105 SERIES

REAR SUSPENSION

PART NO.	QTY	DESCRIPTION	RRP inc GST	NOTES
SHOCK ABSORBERS				
FC41111	2	41mm Foam Cell Shocks		Suits up to 50mm Lift
BM401111	2	40mm 9 Stage Adjustable Shock		Suits up to 50mm Lift
BMX1111/2	2	45mm 9 Stage Adjustable Shock		Suits 50mm Lift ONLY
TDR1111	2	53mm 'Ralph' Big Bore Shock		Suits up to 50mm Lift
COIL SPRINGS				
TDC945S	2	25mm Lift 0-300Kg Load		3/90-91 80 Series Application Suits 25mm Lift
TDC949L	2	25mm Lift CONSTANT 300kg		
TDC949HL	2	25mm Lift CONSTANT 500kg		
TDC945	2	50mm Lift 0-300Kg Load		3/90-91 80 Series Application Suits 50mm Lift
TDC945H	2	50mm Lift CONSTANT 300kg		
TDC949SL	2	25mm Lift 0-300Kg Load		9/91-98 80 Series & 3/98-07 100 Series Application Suits 25mm Lift
TDC949HSL	2	25mm Lift CONSTANT 300kg		
TDC949L	2	25mm Lift CONSTANT 500kg		
TDC945S	2	50mm Lift No Load		9/91-98 80 Series & 3/98-07 100 Series Application Suits 50mm Lift
TDC949L	2	50mm Lift 0-300Kg Load		
TDC949HL	2	50mm Lift CONSTANT 300kg		
TDC945H	2	50mm Lift CONSTANT 500kg		
PANHARD ROD				
TDPR-007	1	Adjustable Panhard Rod		
COMPONENTS				
TDUK-045	1	Trailing Arm Bushing Kit (Upper)		1 Kit required (Upper)
TDUK-046	1	Trailing Arm Bushing Kit (Lower)		1 Kit required (Lower)
TDUK-047	1	Panhard Rod Bush Kit		1 Kit required per panhard rod
TDUK-1724/15	1	Urethane Spring Spacer 15mm		1 per coil as required
TDUK-1724/30	1	Urethane Spring Spacer 30mm		1 per coil as required
AIR ASSIST BAGS				
TDAA-021	1	Coil insert bag kit		Suits standard height ONLY
TDAA-010	1	Coil insert bag kit		Suits up to 25mm Lift
TDAA-011	1	Coil insert bag kit		Suits up to 50mm Lift

COMPLETE KIT PRICE REFERENCE

SHOCK CHOICE	SPRING CHOICE	RRP inc GST	CONTENTS
41mm Foam Cell	\$135 Rear Coils		
	\$175 Rear Coils		
	\$196 Rear Coils		
40mm 9 Stage Adjustable	\$135 Rear Coils		
	\$175 Rear Coils		
	\$196 Rear Coils		
45mm Big Bore or 53mm 'Ralph'	\$135 Rear Coils		
	\$175 Rear Coils		
	\$196 Rear Coils		

All prices exclude freight. Include only permanent accessories & weights when selecting springs. Towing weight is not included

TOYOTA

LANDCRUISER

1/90-07

80 & 105 SERIES 3" LIFT



FRONT SUSPENSION

ESTIMATED LIFT: 75mm

PART NO.	QTY	DESCRIPTION	RRP inc GST	NOTES
SHOCK ABSORBERS				
FC41002	2	41mm Foam Cell Shocks		Suits 75mm Lift
BM401002	2	40mm 9 Stage Adjustable Shock		Suits 75mm Lift
BMX1002/2	2	45mm 9 Stage Adjustable Shock		Suits 75mm Lift
TDR1002B	2	53mm 'Ralph' Big Bore Shock		Suits 75mm Lift
COIL SPRINGS				
TDC943	2	Petrol/Alloy Bar		75mm Lift Spring
TDC948/3	2	Diesel/Bar		75mm Lift Spring
TDC943H	2	Petrol/Diesel Bar & Winch		75mm Lift Spring
STEERING STABILIZERS				
EXT5001	1	H/Duty Replacement Damper		
SS5001-P/S	1	Return to Centre Damper		
SV5001	1	9 Stage Adjustable Damper		
CASTER CORRECTION				
TDUK-054/2	1	2 Degree Caster Correction Bush		instructions at toughdog.com.au
PANHARD ROD				
TDPR-006	1	Adjustable Panhard Rod		
TDPR-001	1	Adjustable Panhard Rod		LHD ONLY
COMPONENTS				
TDUK-044	1	Front Radius Rod to Chassis		1 Kit required per vehicle
TDUK-050	1	Front Radius Rod to Diff		1 Kit required per vehicle
TDUK-043	1	Panhard Rod Bush Kit		1 Kit required per panhard rod
TDUK-1725/20	1	Urethane Spring Spacer 20mm		1 required per coil as required
TDUK-1725/30	1	Urethane Spring Spacer 30mm		1 required per coil as required
TAK-8005	1	Offset Kingpin		0.5 Degree
TAK-8075	1	Offset Kingpin		0.75 Degree
TAK-8001	1	Offset Kingpin		1.0 Degree
BRAKE HOSE KITS				
TDBH-003	1	Rubber Brake Hose Kit		80 & 105 Series Non ABS
TDBH-197	1	Braided Brake Hose Kit		
TDBH-300	1	Rubber Brake Hose Kit		80 Series with ABS
TDBH-200	1	Braided Brake Hose Kit		
TDBH-398	1	Rubber Brake Hose Kit		105 Series with ABS
TDBH-198	1	Braided Brake Hose Kit		

**FOR REPLACEMENT BUSHING PART NUMBERS, PLEASE SEE
PAGE (P176) PREVIOUS IN CATALOGUE**

Fitting sheet (located page 208) must be completed when suspension fitted. Failure to comply may affect warranty.

**KIT PRICING REFERENCE
COMPONENTS AS PER IMAGE**
please order using part numbers

TOYOTA
LANDCRUISER
1/90-07
80 & 105 SERIES 3" LIFT

REAR SUSPENSION

PART NO.	QTY	DESCRIPTION	RRP inc GST	NOTES
SHOCK ABSORBERS				
FC41111	2	41mm Foam Cell Shocks		Suits 75mm Lift
BM401111	2	40mm 9 Stage Adjustable Shock		Suits 75mm Lift
BMX1111/2	2	45mm 9 Stage Adjustable Shock		Suits 75mm Lift
TDR1111	2	53mm 'Ralph' Big Bore Shock		Suits 75mm Lift
COIL SPRINGS				
TDC949/3	2	75mm Lift 0-300Kg Load		75mm Lift Spring
TDC945	2	75mm Lift CONSTANT 300kg		75mm Lift Spring
TDC945H	2	75mm Lift CONSTANT 500kg		75mm Lift Spring
PANHARD ROD				
TDPR-007	1	Adjustable Panhard Rod		
COMPONENTS				
TDUK-045	1	Trailing Arm Bushing Kit (Upper)		1 Kit required (Upper)
TDUK-046	1	Trailing Arm Bushing Kit (Lower)		1 Kit required (Lower)
TDUK-047	1	Panhard Rod Bush Kit		1 Kit required per panhard rod
TDUK-1724/15	1	Urethane Spring Spacer 15mm		1 per coil as required
TDUK-1724/30	1	Urethane Spring Spacer 30mm		1 per coil as required

COMPLETE KIT PRICE REFERENCE

SHOCK CHOICE	SPRING CHOICE	RRP inc GST	CONTENTS
41mm Foam Cell	\$135 (F) \$165 (R)		
	\$135 (F) \$196 (R)		
	\$175 (F) \$165 (R)		
	\$175 (F) \$196 (R)		
40mm 9 Stage Adjustable	\$135 (F) \$165 (R)		<p>Includes 4 x Coil Springs 4 x Shocks 2 x Panhard Rods 1 x Caster Correction 1 x Brake Hoses (TDBH-003)</p>
	\$135 (F) \$196 (R)		
	\$175 (F) \$165 (R)		
	\$175 (F) \$196 (R)		
45mm Big Bore or 53mm 'Ralph'	\$135 (F) \$165 (R)		
	\$135 (F) \$196 (R)		
	\$175 (F) \$165 (R)		
	\$175 (F) \$196 (R)		

All prices exclude freight. Include only permanent accessories & weights when selecting springs. Towing weight is not included

TOYOTA

LANDCRUISER

1/90-06

80 & 105 SERIES 4" LIFT



FRONT SUSPENSION

ESTIMATED LIFT: 100mm (4")

PART NO.	QTY	DESCRIPTION	RRP inc GST	NOTES
SHOCK ABSORBERS				
FC41002/4	2	41mm Foam Cell Shocks		Suits 100mm Lift
BMX1002/4	2	45mm 9 Stage Adjustable Shock		Suits 100mm Lift
COIL SPRINGS				
TDC948/4	2	Petrol/Diesel/Bar		100mm Lift Spring
TDC948/4H	2	Petrol/Diesel Bar & Winch		100mm Lift Spring
STEERING STABILIZERS				
SS5001-XHD	1	Return to Centre Damper		SUITS RHD VEHICLE Fitting instructions at toughdog.com.au
SV5001/4	1	9 Stage Adjustable Damper		
SS5002-XHD	1	Return to Centre Damper		SUITS LHD VEHICLE Fitting instructions at toughdog.com.au
SV5002/4	1	9 Stage Adjustable Damper		
CASTER CORRECTION				
TDUK-054/3	1	3 Degree Caster Correction Bush		instructions at toughdog.com.au
PANHARD ROD				
TDPR-006	1	Adjustable Panhard Rod		
TDPR-001	1	Adjustable Panhard Rod		LHD ONLY
COMPONENTS				
TDUK-044	1	Front Radius Rod to Chassis		1 Kit required per vehicle
TDUK-050	1	Front Radius Rod to Diff		1 Kit required per vehicle
TDUK-043	1	Panhard Rod Bush Kit		1 Kit required per panhard rod
TDUK-1725/20	1	Urethane Spring Spacer 20mm		1 required per coil as required
TDUK-1725/30	1	Urethane Spring Spacer 30mm		1 required per coil as required
TAK-8005	1	Offset Kingpin		0.5 Degree
TAK-8075	1	Offset Kingpin		0.75 Degree
TAK-8001	1	Offset Kingpin		1.0 Degree
BRAKE HOSE KITS				
TDBH-003	1	Rubber Brake Hose Kit		
TDBH-197	1	Braided Brake Hose Kit		80 & 105 Series Non ABS
TDBH-300	1	Rubber Brake Hose Kit		
TDBH-200	1	Braided Brake Hose Kit		80 Series with ABS
TDBH-398	1	Rubber Brake Hose Kit		
TDBH-198	1	Braided Brake Hose Kit		105 Series with ABS

FOR REPLACEMENT BUSHING PART NUMBERS, PLEASE SEE PAGE (P176) PREVIOUS IN CATALOGUE

Fitting sheet (located page 208) must be completed when suspension fitted. Failure to comply may affect warranty.

**KIT PRICING REFERENCE
COMPONENTS AS PER IMAGE**
please order using part numbers

TOYOTA
LANDCRUISER
1/90-06
80 & 105 SERIES 4" LIFT

REAR SUSPENSION

PART NO.	QTY	DESCRIPTION	RRP inc GST	NOTES
SHOCK ABSORBERS				
FC41111/4	2	41mm Foam Cell Shocks		Suits 100mm Lift
BMX1111/4	2	45mm 9 Stage Adjustable Shock		Suits 100mm Lift
COIL SPRINGS				
TDC949/4	2	100mm Lift 0-300Kg Load		100mm Lift Spring
TDC949/4H	2	100mm Lift CONSTANT 300kg		100mm Lift Spring
PANHARD ROD				
TDPR-007	1	Adjustable Panhard Rod		
COMPONENTS				
TDUK-045	1	Trailing Arm Bushing Kit (Upper)		1 Kit required (Upper)
TDUK-046	1	Trailing Arm Bushing Kit (Lower)		1 Kit required (Lower)
TDUK-047	1	Panhard Rod Bush Kit		1 Kit required per panhard rod
TDUK-1724/15	1	Urethane Spring Spacer 15mm		1 per coil as required
TDUK-1724/30	1	Urethane Spring Spacer 30mm		1 per coil as required

COMPLETE KIT PRICE REFERENCE

SHOCK CHOICE	SPRING CHOICE	RRP inc GST	CONTENTS
41mm Foam Cell	\$ 175 (F & R)		
	\$185 (F) \$175 (R)		
45mm Big Bore	\$ 175 (F & R)		<p>Includes</p> <ul style="list-style-type: none"> 4 x Coil Springs 4 x Shocks 2 x Panhard Rods 1 x Caster Correction 1 x Brake Hoses (TDBH-003)
	\$185 (F) \$175 (R)		

All prices exclude freight. Include only permanent accessories & weights when selecting springs. Towing weight is not included

TOYOTA

LANDCRUISER

1/90-06

80 & 105 SERIES 5" LIFT



FRONT SUSPENSION

ESTIMATED LIFT: 125mm (5")

PART NO.	QTY	DESCRIPTION	RRP inc GST	NOTES
SHOCK ABSORBERS				
BMX1002/6	2	45mm 9 Stage Adjustable Shock		Suits 125mm Lift
COIL SPRINGS				
TDC948/5	2	Petrol/Diesel/Bar		125mm Lift Spring
TDC948/5H	2	Petrol/Diesel Bar & Winch		125mm Lift Spring
STEERING STABILIZERS				
SS5001-XHD	1	Return to Centre Damper		SUITS RHD VEHICLE
SV5001/4	1	9 Stage Adjustable Damper		Fitting instructions at toughdog.com.au
SS5002-XHD	1	Return to Centre Damper		SUITS LHD VEHICLE
SV5002/4	1	9 Stage Adjustable Damper		Fitting instructions at toughdog.com.au
CASTER CORRECTION				
TDCP-006	1	5 Degree Caster Correction Plate		instructions at toughdog.com.au
PANHARD ROD				
TDPR-006	1	Adjustable Panhard Rod		
TDPR-001	1	Adjustable Panhard Rod		LHD ONLY
COMPONENTS				
TDUK-044	1	Front Radius Rod to Chassis		1 Kit required per vehicle
TDUK-050	1	Front Radius Rod to Diff		1 Kit required per vehicle
TDUK-043	1	Panhard Rod Bush Kit		1 Kit required per panhard rod
TDUK-1725/20	1	Urethane Spring Spacer 20mm		1 required per coil as required
TDUK-1725/30	1	Urethane Spring Spacer 30mm		1 required per coil as required
TAK-8005	1	Offset Kingpin		0.5 Degree
TAK-8075	1	Offset Kingpin		0.75 Degree
TAK-8001	1	Offset Kingpin		1.0 Degree
BRAKE HOSE KITS				
TDBH-003	1	Rubber Brake Hose Kit		80 & 105 Series Non ABS
TDBH-197	1	Braided Brake Hose Kit		
TDBH-300	1	Rubber Brake Hose Kit		80 Series with ABS
TDBH-200	1	Braided Brake Hose Kit		
TDBH-398	1	Rubber Brake Hose Kit		105 Series with ABS
TDBH-198	1	Braided Brake Hose Kit		

**FOR REPLACEMENT BUSHING PART NUMBERS, PLEASE SEE
PAGE (P176) PREVIOUS IN CATALOGUE**

Fitting sheet (located page 208) must be completed when suspension fitted. Failure to comply may affect warranty.

**KIT PRICING REFERENCE
COMPONENTS AS PER IMAGE**
please order using part numbers

TOYOTA
LANDCRUISER
1/90-06
80 & 105 SERIES 5" LIFT

REAR SUSPENSION

PART NO.	QTY	DESCRIPTION	RRP inc GST	NOTES
SHOCK ABSORBERS				
BMX1111/6	2	45mm 9 Stage Adjustable Shock		Suits 125mm Lift
COIL SPRINGS				
TDC949/5	2	125mm Lift 0-300Kg Load		125mm Lift Spring
TDC949/5H	2	125mm Lift CONSTANT 300kg		125mm Lift Spring
PANHARD ROD				
TDPR-007	1	Adjustable Panhard Rod		
COMPONENTS				
TDUK-045	1	Trailing Arm Bushing Kit (Upper)		1 Kit required (Upper)
TDUK-046	1	Trailing Arm Bushing Kit (Lower)		1 Kit required (Lower)
TDUK-047	1	Panhard Rod Bush Kit		1 Kit required per panhard rod
TDUK-1724/15	1	Urethane Spring Spacer 15mm		1 per coil as required
TDUK-1724/30	1	Urethane Spring Spacer 30mm		1 per coil as required

COMPLETE KIT PRICE REFERENCE

SHOCK CHOICE	SPRING CHOICE	RRP inc GST	CONTENTS
45mm Big Bore 9 Stage Adjustable	LIGHT COILS FRONT & REAR ONE SET LIGHT COILS + ONE SET CONSTANT COILS CONSTANT COILS FRONT & REAR		 <p>Includes 4 x Coil Springs 4 x Shocks 2 x Panhard Rods 1 x Caster Correction 1 x Brake Hoses (TDBH-003)</p>

All prices exclude freight. Include only permanent accessories & weights when selecting springs. Towing weight is not included

TOYOTA

LANDCRUISER

1/90-07
80 & 105 SERIES 6" LIFT



FRONT SUSPENSION

ESTIMATED LIFT: 150mm (6")

PART NO.	QTY	DESCRIPTION	RRP inc GST	NOTES
SHOCK ABSORBERS				
BMX1002/6	2	45mm 9 Stage Adjustable Shock		Suits 150mm Lift
COIL SPRINGS				
TDC948/6	2	Petrol/Diesel/Bar		150mm Lift Spring
TDC948/6H	2	Petrol/Diesel Bar & Winch		150mm Lift Spring
STEERING STABILIZERS				
SS5001-XHD	1	Return to Centre Damper		SUITS RHD VEHICLE
SV5001/4	1	9 Stage Adjustable Damper		Fitting instructions at toughdog.com.au
SS5002-XHD	1	Return to Centre Damper		SUITS LHD VEHICLE
SV5002/4	1	9 Stage Adjustable Damper		Fitting instructions at toughdog.com.au
CASTER CORRECTION				
TDCP-006	1	5 Degree Caster Correction Plate		instructions at toughdog.com.au
PANHARD ROD				
TDPR-006	1	Adjustable Panhard Rod		
TDPR-001	1	Adjustable Panhard Rod		LHD ONLY
COMPONENTS				
TDUK-044	1	Front Radius Rod to Chassis		1 Kit required per vehicle
TDUK-050	1	Front Radius Rod to Diff		1 Kit required per vehicle
TDUK-043	1	Panhard Rod Bush Kit		1 Kit required per panhard rod
TDUK-1725/20	1	Urethane Spring Spacer 20mm		1 required per coil as required
TDUK-1725/30	1	Urethane Spring Spacer 30mm		1 required per coil as required
TAK-8005	1	Offset Kingpin		0.5 Degree
TAK-8075	1	Offset Kingpin		0.75 Degree
TAK-8001	1	Offset Kingpin		1.0 Degree
BRAKE HOSE KITS				
TDBH-003	1	Rubber Brake Hose Kit		80 & 105 Series Non ABS
TDBH-197	1	Braided Brake Hose Kit		
TDBH-300	1	Rubber Brake Hose Kit		80 Series with ABS
TDBH-200	1	Braided Brake Hose Kit		
TDBH-398	1	Rubber Brake Hose Kit		105 Series with ABS
TDBH-198	1	Braided Brake Hose Kit		

FOR REPLACEMENT BUSHING PART NUMBERS, PLEASE SEE PAGE (P176) PREVIOUS IN CATALOGUE

Fitting sheet (located page 208) must be completed when suspension fitted. Failure to comply may affect warranty.

**KIT PRICING REFERENCE
COMPONENTS AS PER IMAGE**
please order using part numbers

TOYOTA

LANDCRUISER

1/90-07

80 & 105 SERIES 6" LIFT

REAR SUSPENSION

PART NO.	QTY	DESCRIPTION	RRP inc GST	NOTES
SHOCK ABSORBERS				
BMX1111/6	2	45mm 9 Stage Adjustable Shock		Suits 150mm Lift
COIL SPRINGS				
TDC949/6	2	150mm Lift 0-300Kg Load		150mm Lift Spring
TDC949/6H	2	150mm Lift CONSTANT 300kg		150mm Lift Spring
PANHARD ROD				
TDPR-007	1	Adjustable Panhard Rod		
COMPONENTS				
TDUK-045	1	Trailing Arm Bushing Kit (Upper)		1 Kit required (Upper)
TDUK-046	1	Trailing Arm Bushing Kit (Lower)		1 Kit required (Lower)
TDUK-047	1	Panhard Rod Bush Kit		1 Kit required per panhard rod
TDUK-1724/15	1	Urethane Spring Spacer 15mm		1 per coil as required
TDUK-1724/30	1	Urethane Spring Spacer 30mm		1 per coil as required

COMPLETE KIT PRICE REFERENCE

SHOCK CHOICE	SPRING CHOICE	RRP inc GST	CONTENTS
45mm Big Bore 9 Stage Adjustable	ANY COIL (RHD ONLY)		 <p>Includes 4 x Coil Springs 4 x Shocks 2 x Panhard Rods 1 x Caster Correction 1 x Brake Hoses (TDBH-003)</p>

All prices exclude freight. Include only permanent accessories & weights when selecting springs. Towing weight is not included

TOYOTA

LANDCRUISER

98-07

100 SERIES (IFS)



FRONT SUSPENSION

ESTIMATED LIFT: 25mm

PART NO.	QTY	DESCRIPTION	RRP inc GST	NOTES
SHOCK ABSORBERS				
FC41103	2	41mm Foam Cell Shock		Up to 25mm Lift
TDR1103	2	53mm 'Ralph' Shock		Up to 25mm Lift
TORSION BARS - Strengthening Bracket fitting instructions at toughdog.com.au				
4WTB-1600	1	Replacement Torsion Bars		32mm/1160mm (For Petrol)
4WTB-1610	1	Replacement Torsion Bars		32mm/1210mm (For Diesel)
4WTB-1610/BKT	1	Torsion Bar Strengthening Kit		Required with torsion bars
Adjust Torsion bars after fitting shocks - Ensure a minimum of 60mm Droop is Maintained				
RIM TO GUARD MEASUREMENTS (Bottom of Rim to Guard)				
For 16" Rim	740mm	Torsion Bars must only be adjusted so that the rim to guard measurements are not more than the measurements listed here. Lifting the vehicle higher than the specified measurement will result in the failure of front end components including shock failure.		
For 17" Rim	753mm			

REAR SUSPENSION

SHOCK ABSORBERS				
FC41114	2	41mm Foam Cell Shock		Suits up to 25mm Lift
BM401114	2	40mm 9 Stage Adjustable		
BMX1114/2	2	45mm 9 Stage Adjustable Shocks		
TDR1114	2	53mm 'Ralph' Big Bore		
COIL SPRINGS				
TDC949HSL	2	0-300kg Load		OE Height
TDC949L	2	0-300kg Load		25mm Lift
TDC949HL	2	CONSTANT 300Kg Load		25mm Lift
PANHARD ROD				
TDPR-003	1	Adjustable Panhard Rod		
COMPONENTS				
TDUK-025	1	Trailing Arm Bush Kit		1 Kit required (Upper)
TDUK-026	1	Trailing Arm Bush Kit		1 Kit required (Lower)
TDUK-1724/15	1	Urethane Spring Spacer 15mm		1 per coil as required
TDUK-1724/30	1	Urethane Spring Spacer 30mm		1 per coil as required
AIR ASSIST BAGS				
TDAA-021	1	Coil insert bag kit		Suits standard height ONLY
TDAA-010	1	Coil insert bag kit		Suits up to 25mm Lift
TDAA-011	1	Coil insert bag kit		Suits up to 50mm Lift
REPLACEMENT BUSHES - QUANTITY PER SHOCK				
ADJ300/40	1	Suits Bottom Front Eying		Suits TDR Ralph Shocks Only
404454B	2	Suits Front Top Pin		Pin type bushing
404454B	1	Suits Rear Top of Top Pin		Pin type bushing
404454A	1	Suits Rear Bottom of Top Pin		Pin type bushing
415024	1	Suits Rear Bottom Eying		Eying bushing





Fitting sheet (located page 208) must be completed when suspension fitted. Failure to comply may affect warranty.

TOYOTA

LANDCRUISER

98-07
100 SERIES (IFS)

COMPLETE KIT PRICE REFERENCE

SHOCK CHOICE	SPRING CHOICE	RRP inc GST	CONTENTS
<p>41mm Foam Cell</p> <p><u>Includes</u> 2 x Coil Springs 4 x Shocks 1x Torsion Bar Strengthening Bracket</p>	<p>\$ 135 Coil</p> <p>\$ 175 Coil</p>		
<p>Foam Cell Front Adjustable Rear</p> <p><u>Includes</u> 2 x Coil Springs 4 x Shocks 1x Torsion Bar Strengthening Bracket</p>	<p>\$ 135 Coil</p> <p>\$ 175 Coil</p>		
<p>53mm 'Ralph' Front 45mm Adjustable Rear</p> <p><u>Includes</u> 2 x Coil Springs 4 x Shocks 1x Torsion Bar Strengthening Bracket</p>	<p>\$ 135 Coil</p> <p>\$ 175 Coil</p>		
<p>53mm 'Ralph' Big Bore</p> <p><u>Includes</u> 2 x Coil Springs 4 x Shocks 1x Torsion Bar Strengthening Bracket</p>	<p>\$ 135 Coil</p> <p>\$ 175 Coil</p>		

All prices exclude freight. Include only permanent accessories & weights when selecting springs. Towing weight is not included

TOYOTA

LANDCRUISER

11/07 On
200 Series



FRONT SUSPENSION

ESTIMATED LIFT: 40mm

PART NO.	QTY	DESCRIPTION	RRP inc GST	NOTES
SHOCK ABSORBERS				
FC404900	2	40mm Foam Cell Strut		
BM404900	2	40mm Adjustable Strut		9 Stage Adjustable
BMX454900	2	45mm Adjustable Strut		Does not suit factory coils
COIL SPRINGS				
TDC930SL	2	OE Height Spring		OE Height Spring
TDC930HSL	2	OE Height Spring Bar & Winch		OE Height Spring
TDC930L	2	40mm Lift Spring		With Bar (excl. Sahara)
TDC930HL	2	40mm Lift Spring		With Bar & Winch (incl all Sahara)
TDC932L	2	40mm Lift Spring- BMX strut only		With Bar (OE height for Sahara)
TDC932HL	2	40mm Lift Spring- BMX strut only		With Bar & Winch (incl all Sahara)
COMPLETE STRUT ASSEMBLY				
TOY-200/01	2	BM404900/TDC930L		Petrol/Diesel With Bar
TOY-200/02	2	BM404900/TDC930HL		Petrol/Diesel with Bar & Winch
TOY-200/04	2	FC404900/TDC930L		Petrol/Diesel With Bar
TOY-200/05	2	FC404900/TDC930HL		Petrol/Diesel with Bar & Winch
TOY-200/07	2	BMX454900/TDC932L (45mm)		Petrol/Diesel With Bar
TOY-200/08	2	BMX454900/TDC932HL (45mm)		Petrol/Diesel with Bar & Winch
ADDITIONAL COMPONENTS				
TOY-1020	2	Strut Top		Replacement Strut Top
TDCA-004	1	Upper Control Arms (pair)		Suits up to 75mm lift

REPLACEMENT BUSHES (QUANTITY PER SHOCK)				
TOY-1020	1	Replacement Strut Top		Available As Complete Unit Only
4WAY-001	1	Suits Bottom Front Eying		Eying Bonded Bushing
404454B + 404454A	1 (ea)	Suits Rear Top Pin		Eying Bushing
415024	1	Suits Rear Bottom Eying		

COMPLETE KIT PRICE REFERENCE

SHOCK CHOICE	SPRING CHOICE	RRP inc GST	CONTENTS
Foam Cell Struts Require Assembly	\$ 135 Rear Coils		<p>Includes</p> <p>2 x Front Strut Assy (assembled or separate) 2 x Rear Coil Springs 2 x Rear Shocks</p>
	\$ 175 Rear Coils		
Foam Cell Complete Assembly Struts	\$ 135 Rear Coils		
	\$ 175 Rear Coils		

Note: Vehicles fitted with KDSS require a specific fitment procedure to be followed to avoid failure.

Instructions available at toughdog.com.au

TOYOTA LANDCRUISER 11/07 On 200 Series

REAR SUSPENSION

ESTIMATED LIFT: 20mm

PART NO.	QTY	DESCRIPTION	RRP inc GST	NOTES
SHOCK ABSORBERS				
FC41114	2	41mm Foam Cell Shock		Up to 20mm Lift
BM401114	2	40mm 9 Stage Adjustable		Up to 20mm Lift
BMX1114/2	2	45mm 9 Stage Adjustable		Up to 20mm Lift
TDR1114	2	53mm Big Bore 'Ralph'		Up to 20mm Lift
COIL SPRINGS				
TDC931L	2	0-300kg Load		20mm Lift
TDC931HL	2	CONSTANT 300Kg Load		20mm Lift
TDC931VHL	2	CONSTANT 500Kg Load		20mm Lift
PANHARD ROD				
TDPR-200	2	Adjustable Panhard Rod		
TDSB-006	1	33mm H/D Sway Bar Kit		Suit Non-KDSS only
AIR ASSIST BAGS				
TDAA-021	1	Coil insert bag kit		Suits standard height ONLY
TDAA-010	1	Coil insert bag kit		Suits up to 25mm Lift

COMPLETE KIT PRICE REFERENCE

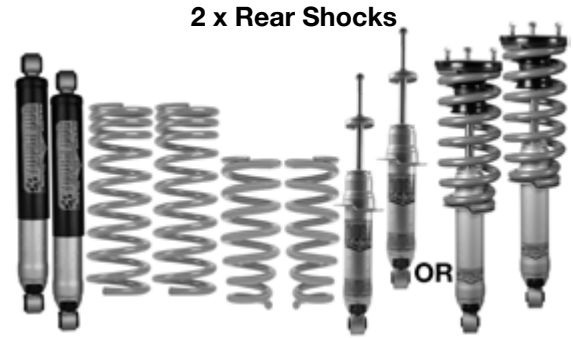
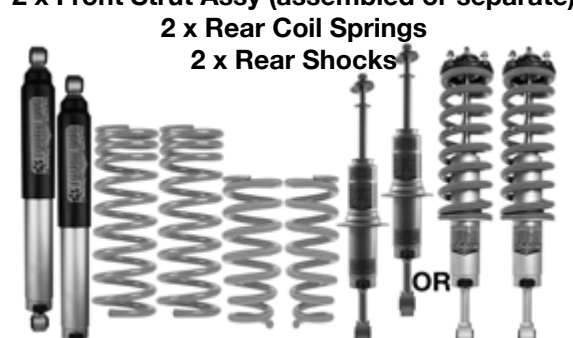
SHOCK CHOICE	SPRING CHOICE	RRP inc GST	CONTENTS
40mm Adjustable Struts Require Assembly	\$ 135 Rear Coils		<p>Includes</p> <p>2 x Front Strut Assy (assembled or separate)</p> <p>2 x Rear Coil Springs</p> <p>2 x Rear Shocks</p> 
	\$ 175 Rear Coils		
40mm Adjustable Complete Assembly Struts	\$ 135 Rear Coils		
	\$ 175 Rear Coils		
45mm Adjustable Struts Require Assembly	\$ 135 Rear Coils		<p>Includes</p> <p>2 x Front Strut Assy (assembled or separate)</p> <p>2 x Rear Coil Springs</p> <p>2 x Rear Shocks</p> 
	\$ 175 Rear Coils		
45mm Adjustable Complete Assembly Struts	\$ 135 Rear Coils		
	\$ 175 Rear Coils		

All prices exclude freight. Include only permanent accessories & weights when selecting springs. Towing weight is not included

P: (02) 9672 8899 | F: (02) 9672 8099



TOYOTA

PRADO

7/96-03

95 SERIES



FRONT SUSPENSION

ESTIMATED LIFT: 40mm

PART NO.	QTY	DESCRIPTION	RRP inc GST	NOTES
SHOCK ABSORBERS				
FC404100	2	40mm Foam Cell Strut		
BM404100	2	40mm Adjustable Strut		9 Stage Adjustable
COIL SPRINGS				
TDC971S	2	25mm Lift Spring		
TDC971	2	40mm Lift Spring		Petrol/Diesel/Bar
TDC971H	2	40mm Lift Spring		Petrol/Diesel/Bar/Winch
COMPLETE STRUT ASSEMBLY				
TOY-095/01	2	BM404100/TDC971		All with/Diesel/Bar
TOY-095/02	2	BM404100/TDC971H		All with/Diesel/Bar/Winch
TOY-095/03	2	FC404100/TDC971		All with/Diesel/Bar
TOY-095/04	2	FC404100/TDC971H		All with/Diesel/Bar/Winch
TOY-095/05	2	FC404100/TDC971S		All with/Diesel (OE Height)
TOY-095/06	2	BM404100/TDC971S		All with/Bar(OE Height)
REPLACEMENT STRUT ASSEMBLY				
TOY-1081	2	Strut Top		Replacement Strut Top

REAR SUSPENSION





SHOCK ABSORBERS				
FC41108	2	41mm Foam Cell Shock		OE Height
BM401108	2	40mm 9 Stage Adjustable		
FC41113	2	41mm Foam Cell Shock		40mm Lift
BM401113	2	40mm 9 Stage Adjustable		
COIL SPRINGS				
TDC973S	2	0-300kg Load		25mm Lift
TDC973	2	0-300kg Load		40mm Lift
TDC973H	2	CONSTANT 300Kg Load		40mm Lift

REPLACEMENT BUSHINGS

QUANTITY PER SHOCK				
TOY-1081	1	Replacement Strut Top		Available As Complete Unit Only
ADJ300/40	1	Suits Bottom Front Eying		Eying Bonded Bushing
TW959	2	Suits Top Rear Pin Mount		Pin Style Bushing
ADJ00191	1	Suits Rear Bottom Eying		Eying Bushing

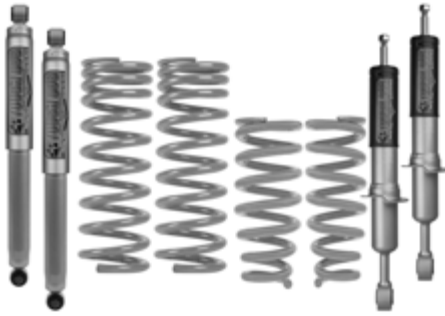
Fitting sheet (located page 208) must be completed when suspension fitted. Failure to comply may affect warranty.

COMPLETE KIT PRICE REFERENCE

SHOCK CHOICE	SPRING CHOICE	RRP inc GST	CONTENTS
<p>Foam Cell Struts Require Assembly Includes 4 x Coil Springs 4 x Shocks</p>	ANY	\$ 1388	
<p>Foam Cell Complete Assembly Struts Includes 2 x Front Strut Assy 2 x Coil Springs 2 x Rear Shocks</p>	ANY	\$ 1534	
<p>40mm Adjustable Struts Require Assembly Includes 4 x Coil Springs 4 x Shocks</p>	ANY	\$ 1574	
<p>40mm Adjustable Complete Assembly Struts Includes 2 x Front Strut Assy 2 x Coil Springs 2 x Rear Shocks</p>	ANY	\$ 1720	

All prices exclude freight. Include only permanent accessories & weights when selecting springs. Towing weight is not included

TOYOTA

PRADO

2/03-10

120 SERIES LWB & SWB



FRONT SUSPENSION

ESTIMATED LIFT: 40mm

PART NO.	QTY	DESCRIPTION	RRP inc GST	NOTES
SHOCK ABSORBERS				
FC404400	2	40mm Foam Cell Strut		
BM404400	2	40mm Adjustable Strut		9 Stage Adjustable
COIL SPRINGS - Please check LWB/SWB prior to ordering				
TDC974S	2	OE Height Spring		Petrol/Diesel/Bar
TDC974	2	40mm Lift Spring		Petrol/Diesel/Bar
TDC974H	2	40mm Lift Spring		Petrol/Diesel/Bar/Winch
COMPLETE STRUT ASSEMBLY - Please check LWB/SWB prior to ordering				
TOY-120/01	2	BM404400/TDC974		All With Bar
TOY-120/02	2	BM404400/TDC974H		All With Bar/Winch
TOY-120/03	2	FC404400/TDC974		All With Bar
TOY-120/04	2	FC404400/TDC974H		All With Bar/Winch
TOY-120/07	2	FC404400/TDC974S		All With Bar (OE Height)
TOY-120/08	2	BM404400/TDC974S		All With Bar/Winch (OE Height)
ADDITIONAL COMPONENTS				
TOY-1084	2	Strut Top		Replacement Strut Top
TDSP-011	1	Sway Bar Spacer Kit		76mm hole spacing
TDCA-005	1	Upper Control Arms (pair)		Suits up to 75mm lift

REAR SUSPENSION

SHOCK ABSORBERS				
FC41116	2	41mm Foam Cell Shock		40mm Lift
BM401116	2	40mm 9 Stage Adjustable		
COIL SPRINGS - Please check LWB/SWB prior to ordering				
TDC975S	2	0-300kg Load		OE Height - Suit LWB
TDC975	2	0-300kg Load		40mm Lift - Suit LWB
TDC975H	2	CONSTANT 300Kg Load		40mm Lift - Suit LWB
TDC975S	2	0-300kg Load		40mm Lift - Suit SWB
TDC975	2	CONSTANT 300Kg Load		40mm Lift - Suit SWB
TDC975AB	2	0-300kg Load		40mm Lift - Airbag Conversion
TDC975HAB	2	CONSTANT 300Kg Load		40mm Lift - Airbag Conversion
AIR ASSIST BAGS - Coil Insert only and does not suit OEM airbag replacement				
TDAA-009	1	Coil insert bag kit		Suits up to 40 mm Lift
TDAA-020	1	Coil insert bag kit		Suits standard height ONLY

REPLACEMENT BUSHINGS

QUANTITY PER SHOCK				
TOY-1084	1	Replacement Strut Top		Available As Complete Unit Only
ADJ300/40	1	Suits Bottom Front Eying		Eying Bonded Bushing
TW967	2	Suits Top Rear Pin Mount		Pin Style Bushing
415024	1	Suits Rear Bottom Eying		Eying Bushing

Fitting sheet (located page 208) must be completed when suspension fitted. Failure to comply may affect warranty.





TOYOTA

PRADO

2/03-2010

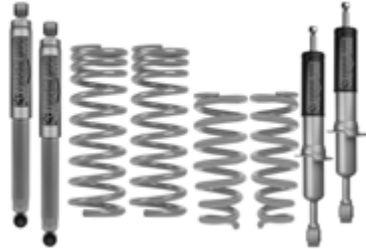
120 SERIES LWB & SWB

COMPLETE KIT PRICE REFERENCE

SHOCK CHOICE	SPRING CHOICE	RRP inc GST	CONTENTS
Foam Cell Struts Require Assembly Includes 4 x Coil Springs 4 x Shocks 1 x Sway Bar Spacer	ANY		
Foam Cell Complete Assembly Struts Includes 2 x Front Strut Assy 2 x Coil Springs 2 x Rear Shocks 1 x Sway Bar Spacer	ANY		
40mm Adjustable Struts Require Assembly Includes 4 x Coil Springs 4 x Shocks 1 x Sway Bar Spacer	ANY		
40mm Adjustable Complete Assembly Struts Includes 2 x Front Strut Assy 2 x Coil Springs 2 x Rear Shocks 1 x Sway Bar Spacer	ANY		

OEM AIRBAG VEHICLES

NOTES ON CONVERSION (Replacing Dampers only)

The electronically controlled dampers on 120 series prado can be replaced with Tough Dog shock absorbers without error indicators appearing on the instrument cluster.

It is imperative that all four shock absorbers are replaced at the same time.

If operating correctly, the electronically adjustable height control of the rear air springs will not be affected if all four dampers are replaced at the same time.

NOTES ON CONVERSION (Replacing airbags & Dampers)

When converting from air springs to conventional coils at the rear of prado 120 series, the electronic workaround detailed in the instructions provided with the rear springs prevents the error indicator from being displayed in the instrument cluster.

The electronic workaround will also disable the electronic damping system, it is therefore important that all four dampers must be replaced if the air bag system is converted to coil springs.

Toyota Genuine Bumpstop part number 48302-35040 spring seat sub assembly should be ordered through Toyota

All prices exclude freight. Include only permanent accessories & weights when selecting springs. Towing weight is not included

P: (02) 9672 8899 | F: (02) 9672 8099



TOYOTA

PRADO

2010 On

150 SERIES LWB & SWB



FRONT SUSPENSION

ESTIMATED LIFT: 40mm

PART NO.	QTY	DESCRIPTION	RRP inc GST	NOTES
SHOCK ABSORBERS				
FC404400	2	40mm Foam Cell Strut		
BM404400	2	40mm Adjustable Strut		9 Stage Adjustable
COIL SPRINGS - Please check LWB/SWB prior to ordering				
TDC974H	2	40mm Lift Spring		Suits with Bar - Suit LWB
TDC974HH	2	40mm Lift Spring		Suits with Bar & Winch - Suit LWB
TDC974S	2	40mm Lift Spring		Suits with Bar - Suit SWB
TDC974	2	40mm Lift Spring		Suits with Bar & Winch - Suit SWB
COMPLETE STRUT ASSEMBLY - Please check LWB/SWB prior to ordering				
TOY-150/03	2	BM404400/TDC974H		All with Bar - Suit LWB
TOY-150/04	2	BM404400/TDC974HH		All with Bar & Winch - Suit LWB
TOY-150/07	2	FC404400/TDC974H		All with Bar - Suit LWB
TOY-150/08	2	FC404400/TDC974HH		All with Bar & Winch - Suit LWB
TOY-150/01	2	BM404400/TDC974S		All with Bar - Suit SWB
TOY-150/02	2	BM404400/TDC974		All with Bar & Winch - Suit SWB
TOY-150/05	2	FC404400/TDC974S		All with Bar - Suit SWB
TOY-150/06	2	FC404400/TDC974		All with Bar & Winch - Suit SWB
REPLACEMENT STRUT ASSEMBLY				
TOY-1083	2	Strut Top		Replacement Strut Top
TDSP-012	1	Sway Bar Spacer Kit		83mm hole spacing
TDCA-005	1	Upper Control Arms (pair)		Suits up to 75mm lift

REAR SUSPENSION

SHOCK ABSORBERS				
FC41118	2	41mm Foam Cell Shock		40mm Lift
BM401118	2	40mm 9 Stage Adjustable		
COIL SPRINGS - Please check LWB/SWB prior to ordering				
TDC975S	2	0-300kg Load		OE Height - Suit LWB
TDC975	2	0-300kg Load		40mm Lift - Suit LWB
TDC975H	2	CONSTANT 300Kg Load		40mm Lift - Suit LWB
TDC975S	2	0-300kg Load		40mm Lift - Suit SWB
TDC975	2	CONSTANT 300Kg Load		40mm Lift - Suit SWB
AIR ASSIST BAGS				
TDAA-009	1	Coil insert bag kit		Suits up to 40 mm Lift
TDAA-020	1	Coil insert bag kit		Suits standard height ONLY
REPLACEMENT BUSHINGS (QUANTITY PER SHOCK)				
TOY-1083	1	Replacement Strut Top		Available As Complete Unit Only
ADJ300/40	1	Suits Bottom Front Eying		Eying Bonded Bushing
TW967	2	Suits Top Rear Pin Mount		Pin Style Bushing
415024	1	Suits Rear Bottom Eying		Eying Bushing

Fitting sheet (located page 208) must be completed when suspension fitted. Failure to comply may affect warranty.





TOYOTA

PRADO

2010 On

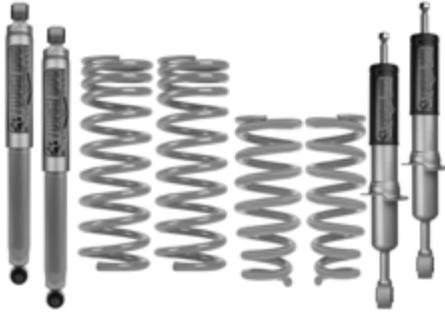
150 SERIES LWB & SWB

COMPLETE KIT PRICE REFERENCE

SHOCK CHOICE	SPRING CHOICE	RRP inc GST	CONTENTS
<p>Foam Cell Struts Require Assembly</p> <p><u>Includes</u> 4 x Coil Springs 4 x Shocks 1 x Sway Bar Spacer</p>	ANY		
<p>Foam Cell Complete Assembly Struts</p> <p><u>Includes</u> 2 x Front Strut Assy 2 x Coil Springs 2 x Rear Shocks 1 x Sway Bar Spacer</p>	ANY		
<p>40mm Adjustable Struts Require Assembly</p> <p><u>Includes</u> 4 x Coil Springs 4 x Shocks 1 x Sway Bar Spacer</p>	ANY		
<p>40mm Adjustable Complete Assembly Struts</p> <p><u>Includes</u> 2 x Front Strut Assy 2 x Coil Springs 2 x Rear Shocks 1 x Sway Bar Spacer</p>	ANY		

All prices exclude freight. Include only permanent accessories & weights when selecting springs. Towing weight is not included

TOYOTA

FJ CRUISER

11-16

All Models



FRONT SUSPENSION

ESTIMATED LIFT: 40mm

PART NO.	QTY	DESCRIPTION	RRP inc GST	NOTES
SHOCK ABSORBERS				
FC404400	2	40mm Foam Cell Strut		
BM404400	2	40mm Adjustable Strut		9 Stage Adjustable
COIL SPRINGS				
TDC974H	2	40mm Lift Spring		Suits with Bar
TDC974HH	2	40mm Lift Spring		Suits with Bar & Winch
COMPLETE STRUT ASSEMBLY				
TOY-150/03	2	BM404400/TDC974H		All with Bar
TOY-150/04	2	BM404400/TDC974HH		All with Bar & Winch
TOY-150/07	2	FC404400/TDC974H		All with Bar
TOY-150/08	2	FC404400/TDC974HH		All with Bar & Winch
ADDITIONAL COMPONENTS				
TOY-1083	2	Strut Top		Replacement Strut Top
TDCA-005	1	Upper Control Arms (pair)		Suits up to 75mm lift
TDSP-011	1	Sway Bar Spacer Kit		76mm spacing - 06-2009 vehicles
TDSP-012	1	Sway Bar Spacer Kit		83mm spacing - 2010 on vehicles
Check hole spacing of sway bar mounting locations to ensure the correct kit is ordered.				

REAR SUSPENSION

SHOCK ABSORBERS				
FC41116	2	41mm Foam Cell Shock		40mm Lift
BM401116	2	40mm 9 Stage Adjustable		
COIL SPRINGS				
TDC975	2	0-300kg Load		40mm Lift
TDC975H	2	CONSTANT 300Kg Load		40mm Lift
AIR ASSIST BAGS				
TDAA-009	1	Coil insert bag kit		Suits up to 40 mm Lift
TDAA-020	1	Coil insert bag kit		Suits standard height ONLY

REPLACEMENT BUSHINGS

QUANTITY PER SHOCK				
TOY-1083	1	Replacement Strut Top		Available As Complete Unit Only
ADJ300/40	1	Suits Bottom Front Eying		Eying Bonded Bushing
TW967	2	Suits Top Rear Pin Mount		Pin Style Bushing
415024	1	Suits Rear Bottom Eying		Eying Bushing





Fitting sheet (located page 208) must be completed when suspension fitted. Failure to comply may affect warranty.

TOYOTA

FJ CRUISER

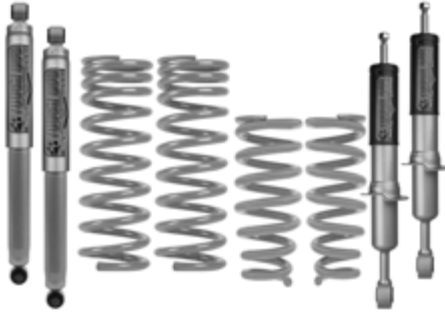
11-16

COMPLETE KIT PRICE REFERENCE

SHOCK CHOICE	SPRING CHOICE	RRP inc GST	CONTENTS
<p>Foam Cell Struts Require Assembly <u>Includes</u> 4 x Coil Springs 4 x Shocks 1 x Sway Bar Spacer</p>	ANY		
<p>Foam Cell Complete Assembly Struts <u>Includes</u> 2 x Front Strut Assy 2 x Coil Springs 2 x Rear Shocks 1 x Sway Bar Spacer</p>	ANY		
<p>40mm Adjustable Struts Require Assembly <u>Includes</u> 4 x Coil Springs 4 x Shocks 1 x Sway Bar Spacer</p>	ANY		
<p>40mm Adjustable Complete Assembly Struts <u>Includes</u> 2 x Front Strut Assy 2 x Coil Springs 2 x Rear Shocks 1 x Sway Bar Spacer</p>	ANY		

All prices exclude freight. Include only permanent accessories & weights when selecting springs. Towing weight is not included

TOYOTA

RAV 4
5/94-00
SXA 10, 11



FRONT SUSPENSION

ESTIMATED LIFT: 30mm

PART NO.	QTY	DESCRIPTION	RRP inc GST	NOTES
SHOCK ABSORBERS				
BDS4001	2	Nitro gas Strut Insert		Suits up to 30mm Lift
COIL SPRINGS				
TDC981	2	30mm Lift Spring		

REAR SUSPENSION

SHOCK ABSORBERS				
BD1106TB	2	35mm Nitro Gas Shocks		Suits up to 30mm Lift
BM401106	2	40mm 9 Stage Adjustable		
COIL SPRINGS				
TDC982	2	0-300kg Load		30mm Lift Spring

REPLACEMENT BUSHINGS

QUANTITY PER SHOCK				
TW959	2	Suits Top Rear Pin Mount		Pin Style Bushing
ADJ00191	1	Suits Rear Bottom Eying		Eying Bushing

COMPLETE KIT PRICE REFERENCE

SHOCK CHOICE	SPRING CHOICE	RRP inc GST	CONTENTS
35mm Nitro Gas	ANY COIL		
Nitro Gas Front Adjustable Rear	ANY COIL		
Includes 4 x Coil Springs 2 x Shocks 2 x Front strut inserts			

Fitting sheet (located page 208) must be completed when suspension fitted. Failure to comply may affect warranty.



TOYOTA

TUNDRA

03/07 On
UCK, UPK, USK 55, 56

FRONT SUSPENSION

ESTIMATED LIFT: 45mm

PART NO.	QTY	DESCRIPTION	RRP inc GST	NOTES
SHOCK ABSORBERS				
FC404910	2	40mm Foam Cell Strut		Suits up to 45m Lift
BM404910	2	40mm Adjustable Strut		Suits up to 45m Lift
COIL SPRINGS				
TDC930L	2	45mm Lift Spring		Suits with Alloy Bar
TDC930HL	2	45mm Lift Spring		Suits with Bar/Winch

REAR SUSPENSION

SHOCK ABSORBERS				
FC41117	2	41mm Foam Cell Shocks		Suits 45mm Lift
BM401117	2	40mm Adjustable Shocks		
LEAF SPRINGS				
FS701	2	0-300kg Load 45mm Lift Spring		Includes bushings in spring
COMPONENTS				
TDUK-074	1	Urethane Shackle Bushing Kit		Not required if ordering FS701
TDUK-076	1	Urethane Chassis Bush Only		Required for lift kit
TDUB-016HD	2	U-Bolt Kit		

COMPLETE KIT PRICE REFERENCE

SHOCK CHOICE	SPRING CHOICE	RRP inc GST	CONTENTS
41mm Foam Cell	0-300KG		
40mm Adjustable	0-300KG		
Includes 2 x Coil Springs 2 x Shocks 2 x Front struts 1 x Urethane Bushes (TDUK-076) 2 x U-Bolt Kits			

All prices exclude freight. Include only permanent accessories & weights when selecting springs. Towing weight is not included

UAZ

ALL MODELS

1965 On

UAZ, HUNTER, PATRIOT



FRONT SUSPENSION

ESTIMATED LIFT: 40mm

PART NO.	QTY	DESCRIPTION	RRP inc GST	NOTES
SHOCK ABSORBERS				
FC41382	2	41mm Foam Cell Shock		Suits UAZ 452 (65-72), UAZ 469 (72-85) & UAZ 3151 (85-03)
BM401382	2	40mm Adjustable Shock		
FC41391	2	41mm Foam Cell Shock		Suits Hunter (2003 On)
BM401391	2	40mm Adjustable Shock		
FC41150	2	41mm Foam Cell Shock		Suits Patriot (2005 On)
BM401150	2	40mm Adjustable Shock		
COIL SPRINGS				
TDC150SL	2	OE Height Spring		
TDC150L	2	40mm Lift Spring		Suits with Bar
TDC150HL	2	40mm Lift Spring		Suits with Bar & Winch

REAR SUSPENSION

SHOCK ABSORBERS				
FC41382	2	41mm Foam Cell Shock		Suits UAZ 452 (65-72), UAZ 469 (72-85) & UAZ 3151 (85-03)
BM401382	2	40mm Adjustable Shock		
FC41389	2	41mm Foam Cell Shock		Suits Hunter (2003 On)
BM401389	2	40mm Adjustable Shock		
FC41389	2	41mm Foam Cell Shock		Suits Patriot (2005 On)
BM401389	2	40mm Adjustable Shock		
LEAF SPRINGS				
FS160H	2	0-300Kg Load		40mm Lift Spring
FS160HH	2	CONSTANT 400Kg Load		40mm Lift Spring

Fitting sheet (located page 208) must be completed when suspension fitted. Failure to comply may affect warranty.



VOLKSWAGEN

AMAROK
10 On
All Models

ESTIMATED LIFT: 20mm

PART NO.	QTY	DESCRIPTION	RRP inc GST	NOTES
SHOCK ABSORBERS				
FC404730	2	40mm Foam Cell Strut		Not suitable with OE Coils
BM404730	2	40mm Adjustable Strut		Not suitable with OE Coils
COIL SPRINGS - Suits 2.0L Engine Only				
TDC110SL	2	OE Height Spring		
TDC110L	2	20mm Lift Spring		Suits with Bar
TDC110HL	2	20mm Lift Spring		Suits with Bar & Winch
Complete assembly not available for this vehicle. Please visit www.toughdog.com.au for installation video				
COIL SPRINGS - Suits 3.0L V6 Engine Only				
TDC120L	2	20mm Lift Spring		Suits with Bar
TDC120HL	2	20mm Lift Spring		Suits with Bar & Winch

REAR SUSPENSION

SHOCK ABSORBERS				
FC41390	2	41mm Foam Cell Shocks		Up to 20mm Lift
BM401390	2	40mm 9 Stage Adjustable Shock		Up to 20mm Lift
LEAF SPRINGS				
FS710M	2	0-300Kg Load		20mm Lift Spring
FS710HM	2	CONSTANT 300Kg Load		20mm Lift Spring
COMPONENTS				
TDUK-072	1	Urethane Bushing Kit (Leaf)		included in kit pricing
TDUK-075	1	Urethane Bushing Kit (Chassis)		not included in kit pricing (order separately if needed)
Amarok chassis bush has two thicknesses - TDUK-075 includes both sizes - please use correct set.				
TDUB-005	2	U-Bolt Kit		
AIR ASSIST BAGS				
TDAA-114	1	Bellows bag kit		Suits up to 20 mm Lift

COMPLETE KIT PRICE REFERENCE

SHOCK CHOICE	SPRING CHOICE	RRP inc GST	CONTENTS
41mm Foam Cell	0-300kg		
	CONSTANT 300KG		
9 Stage Adjustable	0-300kg		
	CONSTANT 300KG		
Includes 2 x Coil Springs 4 x Shocks 2 x Leaf Springs 1 x Urethane Kit (TDUK-072) 2 x U-Bolt Kits			

All prices exclude freight. Include only permanent accessories & weights when selecting springs. Towing weight is not included

P: (02) 9672 8899 | F: (02) 9672 8099



FITTING SHEET

ESSENTIAL BEFORE & AFTER MEASUREMENTS

PLEASE COMPLETE THIS FORM BEFORE ANY FITMENT

Please File this form with your vehicle service records for reference. Failure to complete this form or may delay resolution of issues.

CUSTOMER DETAILS			
Fitted By:		Date	
Owner's Name		Year	
Address		Make	
Suburb	P'Code	Model	
Phone Number		Odometer:	
Email:		Comments:	

Measurements should be taken from the bottom of the rim to the wheel arch on each corner. In the case of a tray, measure to the same point each time

BEFORE & AFTER MEASUREMENTS	AFTERMARKET FITMENTS	BEFORE & AFTER MEASUREMENTS
-----------------------------	----------------------	-----------------------------

PASSENGER FRONT SIDE	
Original Height	
Height After Lift	
Height 500km Service	
Shock Fitted (P/N)	
Spring Fitted (P/N)	
Comments	

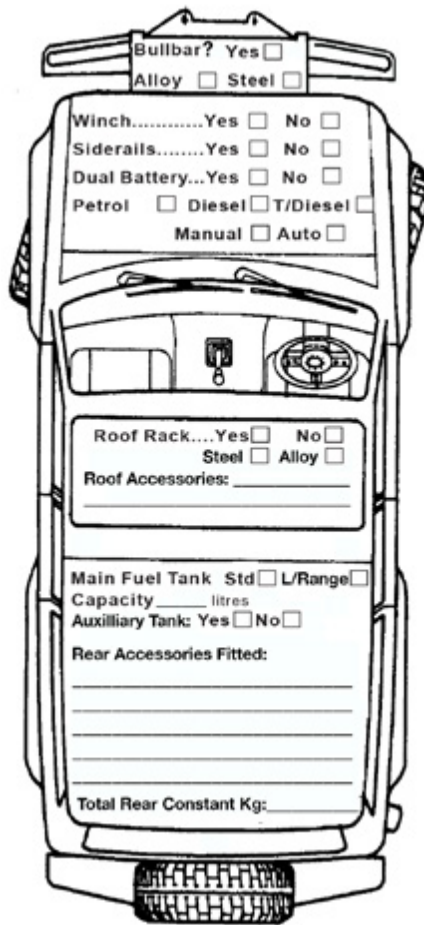

DRIVERS FRONT SIDE	
Original Height	
Height After Lift	
Height 500km Service	
Shock Fitted (P/N)	
Spring Fitted (P/N)	
Comments	

PASSENGER REAR SIDE	
Original Height	
Height After Lift	
Height 500km Service	
Shock Fitted (P/N)	
Spring Fitted (P/N)	
Comments	

DRIVERS REAR SIDE	
Original Height	
Height After Lift	
Height 500km Service	
Shock Fitted (P/N)	
Spring Fitted (P/N)	
Comments	

Fitting sheet (located page 208) must be completed when suspension fitted. Failure to comply may affect warranty.

CLAIMS FORM

WARRANTY & RETURNS

Please Complete this form for all warranty and part return requests. Returned items not accompanied by a form will experience extensive delays in processing

CUSTOMER DETAILS				
Name:				
Address:				
Suburb:		Postcode:		
PURCHASE DETAILS				
Dealer Name:				
Purchase Date:		Invoice No:		
VEHICLE DETAILS				
Year:		Make		Model:
Front?		Rear?		

ITEMS FOR WARRANTY/RETURN

PART NO.	QTY	REASON FOR RETURN	CREDIT AC.	REPLACE ITEM



DISCLAIMER FORM

VEHICLES LIFTED MORE THAN 50MM

Vehicles fitted with a lift kit greater than 50mm over Original Equipment height may not be suitable for on road use. Consult your local Authority or a Qualified Engineer

CUSTOMER DETAILS			
Rego No:		Date	
Owner's Name		Year	
Address		Make	
Suburb		P'Code	
Phone Number		Model	
Email:		Odometer:	
		Comments:	

Declaration

The suspension components fitted to this vehicle (Registration _____) are suitable for off-road use only and may not comply with the requirements of registration. Operation of this vehicle on a road or road related area is done so at the operator's own risk.

Compliance with the requirements of registration is the responsibility of the owner of the vehicle and no liability shall be accepted by any other person. Compliance of the vehicle can be undertaken with the assistance of a qualified certifying Engineer.

Schedule of Parts Fitted		
	FRONT	REAR
Shock Absorbers		
Coil Springs		
Steering Stabilizer		
Panhard Rods		
Castor Bushes/Plates		
Transmission Spacers		
Brake Hoses		

Signed: _____

Date: _____

Name (Print) _____

Disclaimer

4Way Suspension Products Pty Ltd markets a range of off road products that may require certification from a qualified engineer prior to driving on public roads. The fitment of these items and the operation of the vehicle on public roads or road related areas prior to certification may render the vehicle unroadworthy, and may affect the status of your registration. Please check with the relevant ADR authorities in your state or territory and a qualified Engineer. Details of suitable Engineers are provided by the state/territory authority.

Fitting sheet (located page 208) must be completed when suspension fitted. Failure to comply may affect warranty.

VEHICLE WEIGHT

GVM & RELATED INFORMATION

GVM - WHAT IT MEANS TO YOU

The GVM, or Gross Vehicle Mass of any vehicle is the weight in Kg that the manufacturer has specified as being the maximum that the vehicle can weigh when fully loaded.

Exceeding the GVM (overloading the vehicle) can result in premature failure of a range of parts, including structural failure of the chassis.



ACCESSORIES & GVM

When calculating how much load you are able to carry in your vehicle, remember to consider the weight of the accessories fitted. Accessories fitted add to the weight of the car, and reduces the allowable load that the vehicle can carry. These can include:

- Bullbar
- Winch
- Dual Batteries
- Underbody protection plates
- Sidesteps and scrub bars
- Long Range Fuel Tank(s)
- Draw Systems
- Rear bars
- Canopies
- Roof rack & accessories

After adding passengers, fuel, food and water, the vehicle must remain under the specified GVM from the manufacturer to avoid potentially dangerous & expensive vehicle damage and/or component failure. Consideration should be given towards the purchase of an offroad trailer.

Failure to observe the legal GVM of your vehicle is irresponsible and illegal. This may result in legal ramifications including fines and registration. Licence cancellation as well as void insurance in the event of an accident. Vehicles operating above GVM are operating outside the tested and warrantable parameter of the suspension, and are therefore not covered by 4Way Suspension Product Warranty

**SAFETY FIRST,
NEVER OVERLOAD
YOUR VEHICLE!**

All prices exclude freight. Include only permanent accessories & weights when selecting springs. Towing weight is not included